

GTV



KATALOG PRODUKTÓW | **PRODUCT CATALOGUE** | **КАТАЛОГ ПРОДУКЦИИ**

gtv.com.pl

ОŚMIETLENIE MEBLÓWE
FURNITURE LIGHTING
МЕБЕЛЬНОЕ ОСВЕЩЕНИЕ

SYSTEMY PRZESUWNE
SLIDING DOOR SYSTEMS
РАЗДВИЖНЫЕ СИСТЕМЫ

AKCESORIA DEKORACYJNE
DECORATIVE ACCESSORIES
ЛИЦЕВАЯ ФУРНИТУРА

AKCESORIA FUNKCYJNE
FUNCTIONAL ACCESSORIES
ФУНКЦИОНАЛЬНАЯ ФУРНИТУРА

PL GTV to międzynarodowy producent akcesoriów meblowych i oświetlenia. Jest jedną z najdynamiczniej rozwijających się firm w Polsce. Spółka obecna jest na kilkudziesięciu rynkach w Europie, Azji i Ameryce, a produkty z logo GTV znajdują się w milionach domów i biur na całym świecie. GTV jest firmą w 100% z polskim kapitałem. Spółka dysponuje własnym zapleczem techniczno-logistycznym umożliwiającym swobodne prowadzenie działalności o ogólnoświatowym zasięgu. Siedziba firmy to nowoczesne, w pełni z informatyzowane centrum logistyczne w Pruszkowie, w pobliżu autostrady A2. Na jego terenie znajduje się biurowiec oraz dwa magazyny o powierzchni 27 000 m kw. z wydzielonymi składami celnymi, mieszczące 35 000 europalet. Portfolio GTV to jedna z najbardziej kompletnych ofert na rynku. Obejmuje kilka tysięcy produktów, w kilkudziesięciu grupach produktowych, w tym m.in.: zawiasy, prowadnice, podnośniki, uchwyty, wyposażenie garderoby i kuchni oraz oświetlenie LED.

EN GTV is an international producer of furniture accessories and LED lighting. GTV has over 20 years of experience in cooperation with the largest furniture manufacturers in the world and millions of customers using the company's products. Today GTV is one of the international leaders in distribution of furniture accessories and LED lighting, present on dozens of markets worldwide. GTV's headquarter is a modern logistics center, located 25 km from the center of the Polish capital, Warsaw. GTV's head office is a four-story office building and two warehouses on an area of 27000 square meters with storage capacity of over 35,000 euro pallets. With its modern infrastructure, the company is able to fulfill orders from all over the world at the time indicated by the customer. GTV implementing its long-term business strategy, actively promotes its products by participating in the world's most prestigious trade fairs e.g. in Russia, Germany, Italy, Poland, Brazil. Professional service, competent team of specialists and transparent procedures allow us to effectively meet the needs of business partners.

RU GTV – это международный производитель мебелиной фурнитуры и освещения. Мы работаем в десятках стран Европы, Азии и Америки, а продукция с логотипом GTV известна во всем мире. GTV – это современный, полностью информатизированный логистический центр возле Варшавы. На его территории находится офисное здание и два склада площадью 27 000 м2 с отдельными таможенными складами вместимостью 35 000 европаллет. Дополнительно фирма располагает складскими помещениями площадью почти 5000 квадратных метров. Ассортимент компании GTV включает несколько тысяч наименований продукции: петли, направляющие, подъемники, ручки, оснащение для гардероба и кухни, светодиодное освещение.





GTV

FURNITURE
ACCESSORIES

PL GTV Furniture Accessories, marka obecna na rynku od ponad dwudziestu lat to niekwestionowany lider dostarczający najbardziej kompletne portfolio akcesoriów dla branży meblarskiej. Dzięki przemyślanej strategii rozwoju, marka oferuje nieosiągalną dla innych firm relację ceny do jakości, dostarczając funkcjonalne oraz zaprojektowane zgodnie z najnowszymi trendami produkty w przystępnych cenach.

EN GTV Furniture Accessories brand is present on the market for over 20 years, building its position as one of the international leaders. The company is present in Europe, Asia and America, whereas products with the GTV logo are to be found in millions of households and offices worldwide. Thanks to carefully planned strategy and logistics, GTV can offer products with an unreachable for other companies price to quality ratio.

RU Мебельная фурнитура с логотипом GTV известна на рынке уже более двадцати лет, а портфолио компании является одним из наиболее полных предложений на мебельном рынке. Благодаря продуманной стратегии развития, эффективному управлению и открытости к новым идеям, компания GTV быстро стала лидером в дистрибуции мебельной фурнитуры. Секрет успеха компании заключается в предоставлении продукции высокого качества по приемлемой цене.

GTV

SLIDING DOOR SYSTEMS

- PL** GTV Sliding Door Systems, to marka która powstała w 2014 r. z myślą o profesjonalistach poszukujących rozwiązań ułatwiających i przyspieszających montaż drzwi przesuwnych. Systemy przesuwne zostały zaprojektowane przez naszych konstruktorów, dla których inspiracją były opinie polskich stolarzy. Dzięki tej owocnej współpracy powstał produkt, który nie tylko przekonuje praktycznymi, konstrukcyjnymi ulepszeniami. Są to również szczegóły decydujące o przewadze produktu jak unikatowy materiał, z którego wykonane zostały kółka w systemach jezdnych.
- EN** GTV Sliding Door Systems is a brand developed in 2014, for professionals seeking reliability and highest quality. Our systems have been created to meet the needs, of the most demanding customers. The idea behind the systems was inspired by carpenters, who tend to look for solutions, that will make their work more effective. GTV Sliding Door Systems offer not only practical constructional improvements. But also highest quality of components. The whole system is based on reliable elements, especially rollers thanks to which this system stands out of the competition. All of the functional accessories have been carefully selected and underwent thorough strict quality control.
- RU** Раздвижные системы GTV - бренд, созданный в 2014 году с мыслью о профессионалах, ищущих новые возможности, позволяющие ускорить процесс установки раздвижных дверей. Раздвижные системы GTV были запроектированы по инициативе производителей мебели и являются авторской разработкой инженеров компании GTV. В результате плодотворной работы был создан продукт, интересный не только своими техническими решениями, но и отличающийся качеством используемого материала в нижних ходовых элементах.

GTV

LIGHTING

- PL** Marka GTV Lighting została wprowadzona na rynek 2007 r. oferując rozwiązania oświetleniowe przeznaczone do biur, budynków przemysłowych, magazynowych i użyteczności publicznej opartych na technologii LED. Portfolio zawiera również produkty LED dla klientów indywidualnych – źródła LED, oświetlenie meblowe. GTV Lighting to szeroka i kompletna oferta, elastyczność w podejściu do partnerów biznesowych a także serwis.
- EN** The GTV Lighting brand was launched in 2007, it has been created, to provide professional lighting solutions for offices, industrial buildings and warehouses - based on LED technology. The portfolio also includes LED solutions for private consumers – home and garden lighting, furniture lighting. GTV Lighting offers also a wide and complete portfolio of services, such as lighting planning consulting.
- RU** Товарная группа GTV освещение появилась в ассортименте компании в 2007 году и представляет собой подборку интересных световых решений для офисов, промышленных зданий, складских помещений, общественных зданий, а также решений подходящих индивидуальным клиентам – источники светодиодного освещения и освещение для мебели. GTV освещение предлагает широкий спектр продукции и гибкость в подходе к бизнес-партнёрам и услугам, которые мы предоставляем.

AKCESORIA FUNKCYJNE FUNCTIONAL ACCESSORIES ФУНКЦИОНАЛЬНАЯ ФУРНИТУРА

Zawiasy Hinges Петли	8 – 39
Amortyzatory Buffers Амортизаторы	40 – 45 53 – 55
Podnośniki Lifts Подъёмники	46 – 52
Prowadnice Slides Направляющие	56 – 87
Systemy szuflad Drawer systems Выдвижные ящики	88 – 124
Elementy łączeniowe Brackets and fittings Соединительные элементы	125 – 159
Listwy Work top strip Планки для столешниц	160 – 164
Mocowania do rur Rails accessories and fittings Крепление для труб	165 – 183
Wyposażenie garderoby Wardrobe accessories Наполнение для шкафов-купе	184 – 217
Akcesoria kuchenne Kitchen accessories Кухонные аксессуары	218 – 245
Akcesoria biurowe Office accessories Аксессуары для офиса	246 – 259
Inne Other Другие	260 – 263

AKCESORIA DEKORACYJNE DECORATIVE ACCESSORIES ЛИЦЕВАЯ ФУРНИТУРА

Uchwyty Handles Ручки	266 – 347
Wieszaki Hooks Крючки	348 – 364

Wsporniki Shelf supports Полкодержатели	365 – 371
Nóżki meblowe Furniture legs Мебельные ножки	372 – 400
Nogi meblowe Furniture legs Мебельные опоры	401 – 409
Rolki meblowe Furniture castors Мебельные колёсики	410 – 415

SYSTEMY PRZESUWNE SLIDING DOOR SYSTEMS РАЗДВИЖНЫЕ СИСТЕМЫ

Dolny układ jezdny Bottom-running systems Нижняя ходовая система	418 – 448
Górny układ jezdny Top-running systems Верхняя ходовая система	449 – 453

OŚWIETLENIE MEBLOWE FURNITURE LIGHTING МЕБЕЛЬНОЕ ОСВЕЩЕНИЕ

Taśmy LED LED strips Светодиодные ленты	456 – 458
Profile LED LED profiles Профили LED	459 – 486
Oprawy LED LED fittings Светодиодные светильники	487 – 501
Akcesoria Accessories Аксессуары	502 – 529
Przedłużacze biurkowe Desk power sockets Выдвижные удлинители	530 – 545

**AKCESORIA FUNKCYJNE
FUNCTIONAL ACCESSORIES
ФУНКЦИОНАЛЬНАЯ ФУРНИТУРА**

Zawiasy Hinges Петли	8 – 39
Amortyzatory Buffers Амортизаторы	40 – 45 53 – 55
Podnośniki Lifts Подъемники	46 – 52
Prowadnice Slides Направляющие	56 – 87
Systemy szuflad Drawer systems Выдвижные ящики	88 – 124
Elementy łączeniowe Brackets and fittings Соединительные элементы	125 – 159
Listwy Work top strip Планки для столешниц	160 – 164
Mocowania do rur Rails accessories and fittings Крепление для труб	165 – 183
Wyposażenie garderoby Wardrobe accessories Наполнение для шкафов-купе	184 – 217
Akcesoria kuchenne Kitchen accessories Кухонные аксессуары	218 – 245
Akcesoria biurowe Office accessories Аксессуары для офиса	246 – 259
Inne Other Другие	260 – 263





MB

MODERN BOX

Orientacyjna ilość zawiasów puszkowych Ø35*

* Nie dotyczy modeli specjalnych o szerokim kącie otwarcia

Approximate amount of hinges Ø35*

* Not applicable for special hinges with wide opening angle

Приблизительное количество шарнирных петель Ø35*

* Не касается специальных моделей с широким углом открывания

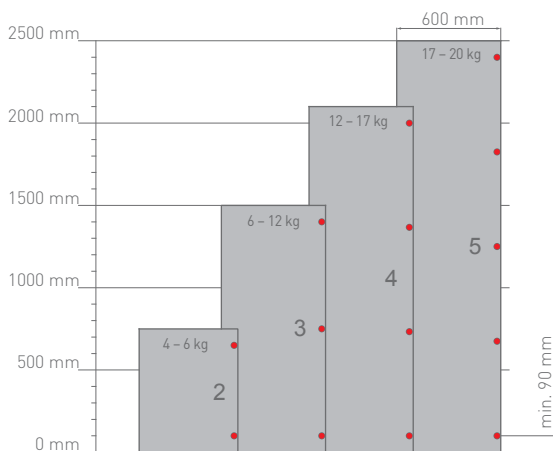

Orientacyjna ilość zawiasów puszkowych Ø26 oraz Ø35*

* Dotyczy modeli specjalnych o szerokim kącie otwarcia

Approximate amount of hinges Ø26 and Ø35*

* Applicable for special hinges with wide opening angle

Приблизительное количество шарнирных петель Ø26 и Ø35*

* Касается специальных моделей с широким углом открывания

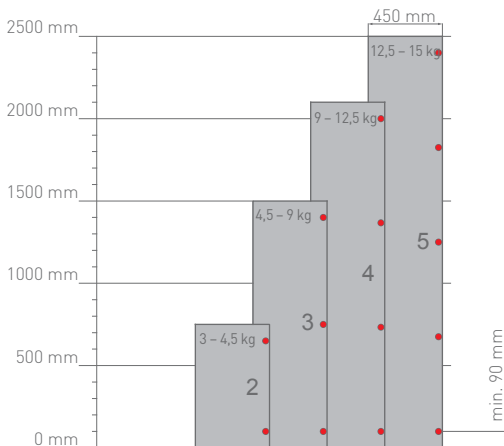

- Ilość użytych zawiasów jest zależna od wysokości, szerokości i ciężaru frontu.
- W celu zapewnienia stabilności odległość między zawiasami powinna być jak największa.
- Przed przystąpieniem do seryjnej produkcji należy przeprowadzić próbę montażu i sprawdzić poprawność funkcjonowania.
- Number of hinges that should be used, depends on the height, width and weight of the front.
- To ensure stability, the distance between the hinges should be as big as possible.
- Before starting mass production, mounting tests should be performed in order to ensure proper functioning.
- Количество использованных петель зависит от высоты, ширины и веса фасада.
- Для обеспечения стабильности, расстояние между петлями должно быть как можно больше.
- Перед началом серийного производства необходимо провести пробу монтажа и проверить исправность функциональности петель.

Zawias hydrauliczny SOLID PLUS, nakładany
 Hydraulic cup hinge SOLID PLUS, overlay door
 Гидравлическая петля SOLID PLUS, накладная

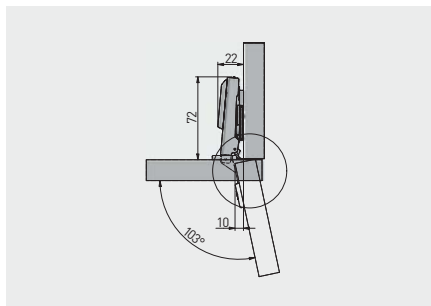

ZM-DCHC09-3DBEO	H = 0	—	—	nikiel nickel	stal steel
ZM-DCHC09-3DZEO		—	x 2	никель	сталь



Zawias hydrauliczny SOLID PLUS, bliźniaczy
 Hydraulic cup hinge SOLID PLUS, twin overlay door
 Гидравлическая петля SOLID PLUS, полунакладная

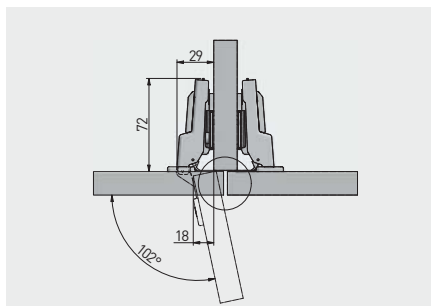

ZM-DCHC08-3DBEO	H = 0	—	—	nikiel nickel	stal steel
ZM-DCHC08-3DZEO		—	x 2	никель	сталь



Zawias hydrauliczny SOLID PLUS, wpuszczany
 Hydraulic cup hinge SOLID PLUS, inset door
 Гидравлическая петля SOLID PLUS, внутренняя

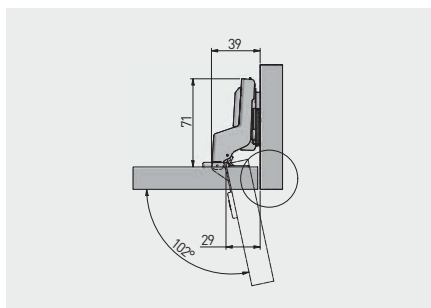

ZM-DCHC07-3DBEO	H = 0	—	—	nikiel	stal
ZM-DCHC07-3DZEO		—	x 2	nickel nikель	steel сталь



Zawias hydrauliczny ECHC, nakładany
 Hydraulic cup hinge ECHC, overlay door
 Гидравлическая петля ECHC, накладная

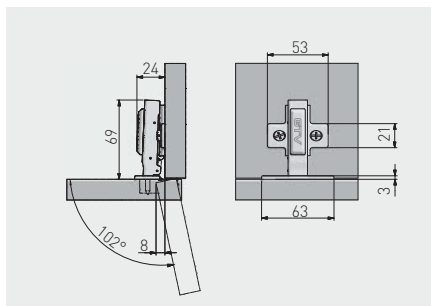

ZM-ECHC09BEO	H=0	x 4	—	nikiel	stal
ZM-ECHC09ZEO		x 2	x 2	nickel никель	steel сталь



Zawias hydrauliczny ECHC, bliźniaczy
 Hydraulic cup hinge ECHC, twin overlay door
 Гидравлическая петля ECHC, полукладная

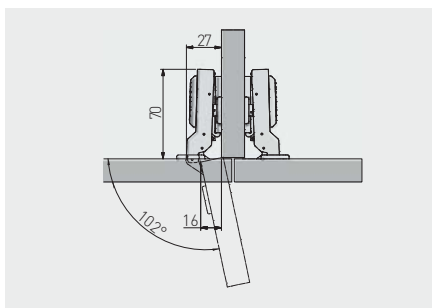

ZM-ECHC08BEO	H=0	x 4	—	nikiel nickel ннкель	stal steel сталь
ZM-ECHC08ZEO		x 2	x 2		



Zawias hydrauliczny ECHC, wpuszczany
 Hydraulic cup hinge ECHC, inset door
 Гидравлическая петля ECHC, внутренняя

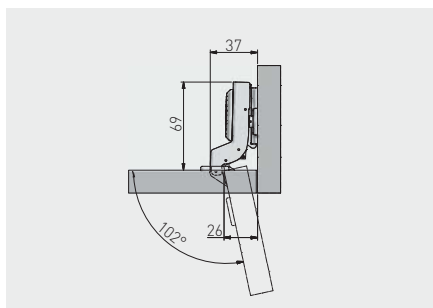

ZM-ECHC07BEO	H = 0	x 4	—	nikiel nickel	stal steel
ZM-ECHC07ZEO		x 2	x 2	никель nickel	сталь steel



Zawias hydrauliczny ECHC, nakładany
 Hydraulic cup hinge ECHC, overlay door
 Гидравлическая петля ECHC, накладная

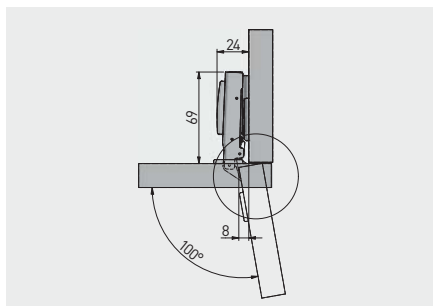

ZM-ECHC09H04-BE	H = 0	x 6	—	nikiel nickel никель	stal steel сталь



Zawias hydrauliczny ECHC, bliźniaczy
 Hydraulic cup hinge ECHC, twin overlay door
 Гидравлическая петля ECHC, полукладная

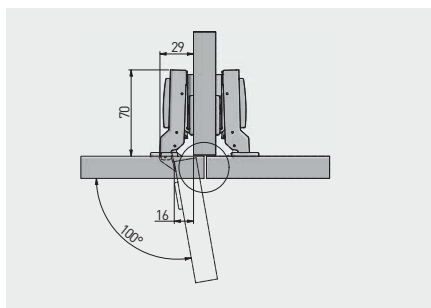

ZM-ECHC08H04-BE	H = 0	x 6	—	nikiel nickel никель	stal steel сталь



Zawias hydrauliczny ECHC, wpuszczany
 Hydraulic cup hinge ECHC, inset door
 Гидравлическая петля ECHC, внутренняя

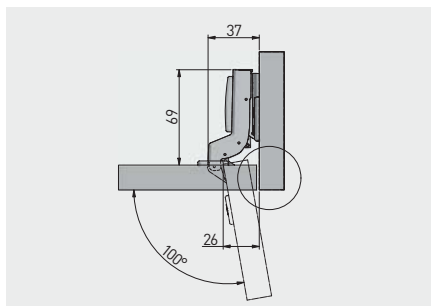

ZM-ECHC07H04-BE	H = 0	x 6	—	nikiel nickel никель	stal steel сталь



Zawias hydrauliczny CNHC z regulacją mimośrodową, nakładany
 Hydraulic cup hinge CNHC with eccentric adjustment, overlay door
 Гидравлическая петля CNHC с эксцентриком, накладная

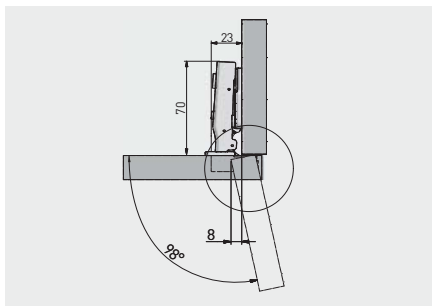

ZM-CNHC09BR2	H = 0	-	-	nikiel nickel никель	stal steel сталь



Zawias hydrauliczny CNHC z regulacją mimośrodową, bliźniaczy
 Hydraulic cup hinge CNHC with eccentric adjustment, twin overlay door
 Гидравлическая петля CNHC с эксцентриком, полунакладная

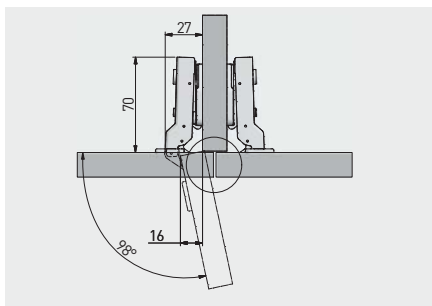

ZM-CNHC08BR2	H = 0	-	-	nikiel nickel никель	stal steel сталь



Zawias hydrauliczny CNHC z regulacją mimośrodową, wpuszczany
 Hydraulic cup hinge CNHC with eccentric adjustment, inset door
 Гидравлическая петля CNHC с эксцентриком, внутренняя

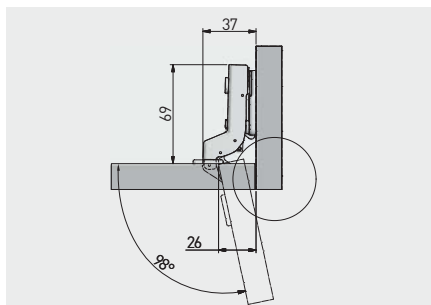

ZM-CNHC07BR2	H = 0	-	-	nikiel nickel никель	stal steel сталь



Zawias hydrauliczny INHC, nakładany
 Hydraulic cup hinge INHC, overlay door
 Гидравлическая петля INHC, накладная

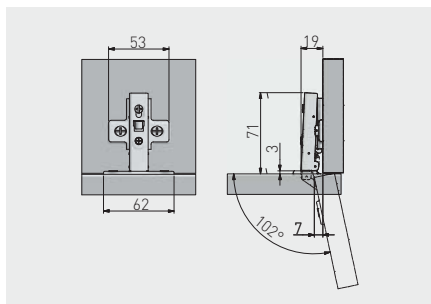

ZM-INHC090BEO	H = 0	-	-	nikiel nickel никель	stal steel сталь
ZM-INHC090ZEO		-	x 2		



Zawias hydrauliczny INHC, bliźniaczy
 Hydraulic cup hinge INHC, twin overlay door
 Гидравлическая петля INHC, полунакладная

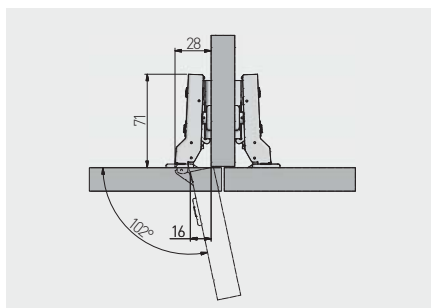

ZM-INHC080BEO	H = 0	—	—	nikiel	stal
ZM-INHC080ZEO		—	x 2	nickel	steel



Zawias hydrauliczny INHC, wpuszczany
 Hydraulic cup hinge INHC, inset door
 Гидравлическая петля INHC, внутренняя

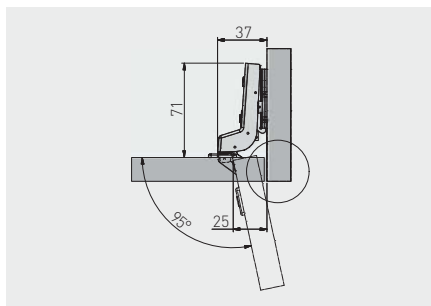

ZM-INHC070BEO	H = 0	—	—	nikiel	stal
ZM-INHC070ZEO		—	x 2	nickel	steel



Zawias kątowy 30°, hydrauliczny HCKT
 Hydraulic corner cup hinge 30° HCKT
 Угловая петля 30°, гидравлическая HCKT

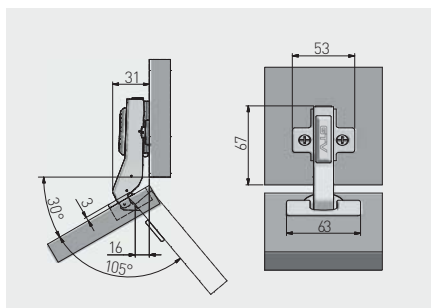

ZM-HCKT30-BE-S	H = 0	x 4	—	nikiel nickel	stal steel
ZM-HCKT30-ZE-S		x 2	x 2	nikiel nickel	stal steel



Zawias kątowy 45° hydrauliczny HCKT
 Hydraulic corner cup hinge 45° HCKT
 Угловая петля 45°, гидравлическая HCKT

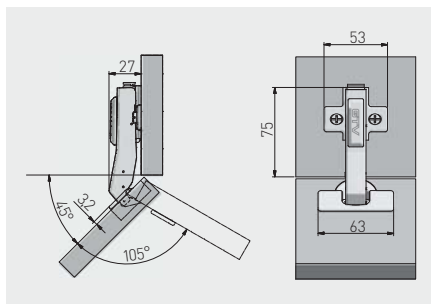

ZM-HCKT45-BE-S	H = 0	x 4	—	nikiel nickel	stal steel
ZM-HCKT45-ZE-S		x 2	x 2	nikiel nickel	stal steel



Zawias kątowy 45° HCKT z regulacją mimośrodową
 Corner hinge 45° HCKT with eccentric adjustment
 Угловая петля 45° HCKT с эксцентриком

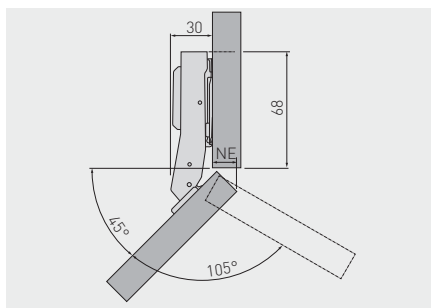

ZM-HCKT45-3DBE0-S	H = 0	—	—	nikiel nickel нickedь	stal steel сталь



Zawias równoległy hydrauliczny HCKT
 Parallel hydraulic hinge HCKT
 Гидравлическая петля под фальшпанель HCKT

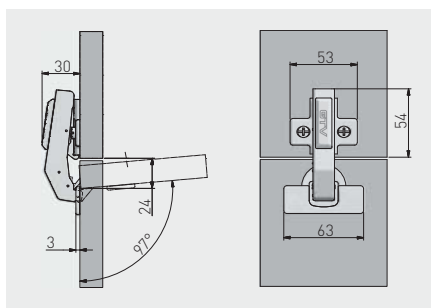

ZM-HCKT90-BE-S	H = 0	x 4	—	nikiel nickel нickedь	stal steel сталь
ZM-HCKT90-ZE-S		x 2	x 2		



Zawias równoległy HCKT z regulacją mimośrodową
 Parallel hinge HCKT with eccentric adjustment
 Петля под фальшпанель HCKT с эксцентриком

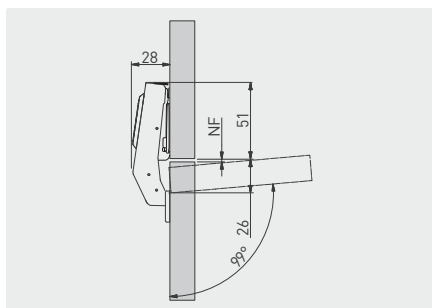

ZM-HCKT90-3DBE0-S	H = 0	—	—	nikiel nickel никель	stal steel сталь



Zawias z ujemnym uskokiem 155° hydrauliczny HCKT
 Hydraulic set-off hinge 155° HCKT
 Гидравлическая петля 155° HCKT

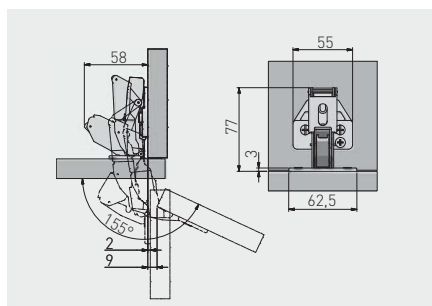

ZM-HCKT155BE	H = 0	—	—	nikiel nickel никель	stal steel сталь
ZM-HCKT155ZE		—	x 2		



Zawias 165° hydrauliczny HCKT
Hydraulic hinge 165° HCKT
Гидравлическая петля 165° HCKT

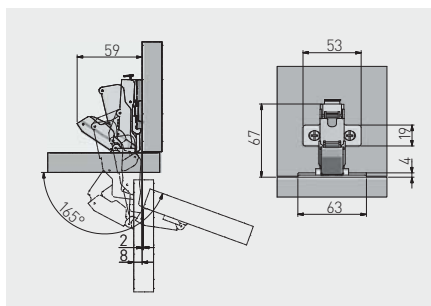

ZM-HCKT165BE-S	H = 0	—	—	nikiel nickel никель	stal steel сталь
ZM-HCKT165ZE-S		—	x 2		



Zawias 165° hydrauliczny HCKT z regulacją mimośrodową
Hydraulic hinge 165° HCKT with eccentric adjustment
Гидравлическая петля 165° HCKT с эксцентриком

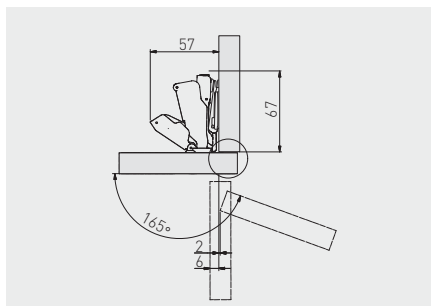

ZM-HCKT165-3DBEO-S	H = 0	—	—	nikiel nickel никель	stal steel сталь



Zawias SOLID, nakładany
Hinge SOLID, overlay door
Петля SOLID, накладная

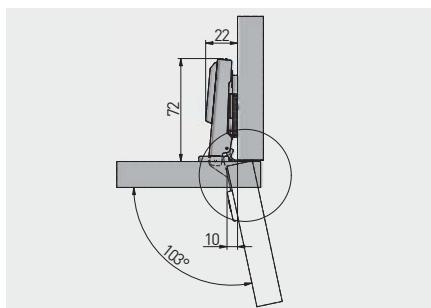

ZP-BIDI09-3DBE0	H = 0	—	—	nikiel nickel никель	stal steel сталь



Zawias SOLID, bliźniaczy
Hinge SOLID, twin overlay door
Петля SOLID, полунакладная

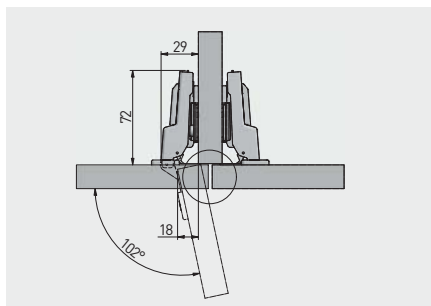

ZP-BIDI08-3DBE0	H = 0	—	—	nikiel nickel никель	stal steel сталь



Zawias SOLID, wpuszczany
Hinge SOLID, inset door
Петля SOLID, внутренняя

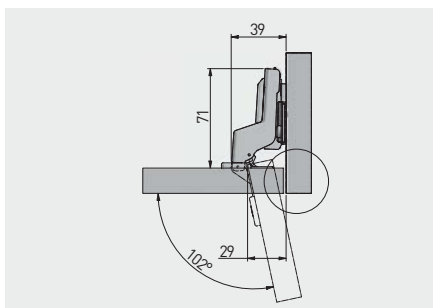

ZP-BIDI07-3DBEO	H = 0	—	—	nikiel nickel никель	stal steel сталь



Zawias CONL, nakładany
Hinge CONL, overlay door
Петля CONL, накладная

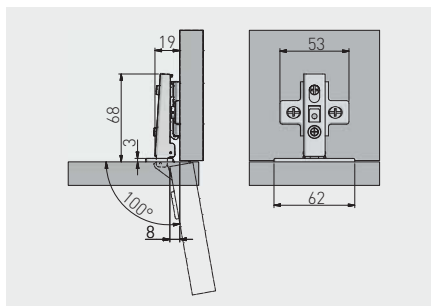

ZP-CONL09-BE	H = 0	—	—	nikiel nickel никель	stal steel сталь
ZP-CONL09-ZE		—	x 2		



Zawias CONL, bliźniaczy
Hinge CONL, twin overlay door
Петля CONL, полукладная

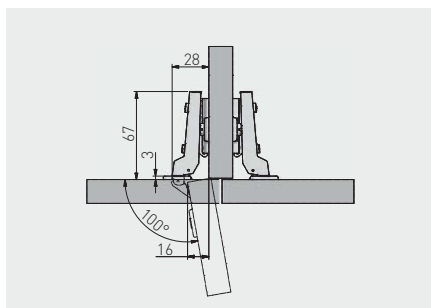

ZP-CONL08-BE	H = 0	—	—	nikiel nickel	stal steel
ZP-CONL08-ZE		—	x 2	никель	сталь



Zawias CONL, wpuszczany
Hinge CONL, inset door
Петля CONL, внутренняя

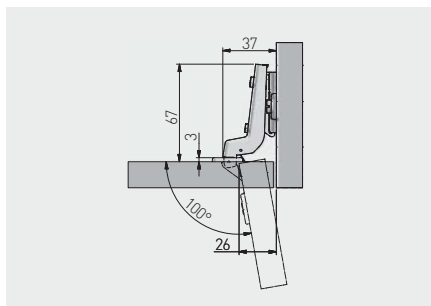

ZP-CONL07-BE	H = 0	—	—	nikiel nickel	stal steel
ZP-CONL07-ZE		—	x 2	никель	сталь



Zawias BICN, nakładany
Hinge BICN, overlay door
Петля BICN, накладная

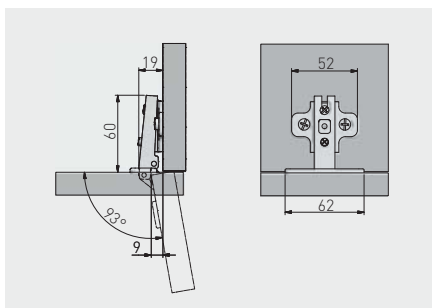

ZP-BICN090BE	H = 0	—	—	nikiel nickel никель	stal steel сталь
ZP-BICN090ZE		—	x 2		
ZP-BICN092BE	H = 2	—	—		
ZP-BICN092ZE		—	x 2		



Zawias BICN, bliźniaczy
Hinge BICN, twin overlay door
Петля BICN, полунакладная

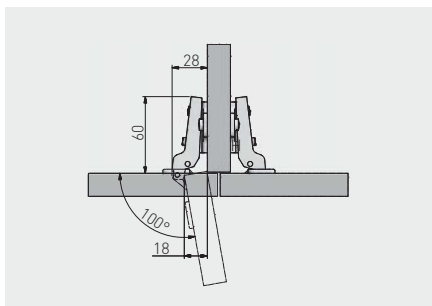

ZP-BICN080BE	H = 0	—	—	nikiel nickel никель	stal steel сталь
ZP-BICN080ZE		—	x 2		
ZP-BICN082BE	H = 2	—	—		
ZP-BICN082ZE		—	x 2		



Zawias BICN, wpuszczany
Hinge BICN, inset door
Петля BICN, внутренняя

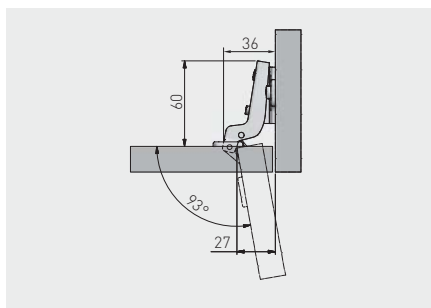

ZP-BICN070BE	H = 0	—	—	nikiel nickel нickedь	stal steel сталь	
ZP-BICN070ZE		—	x 2			
ZP-BICN072BE	H = 2	—	—	nikiel nickel нickedь	stal steel сталь	
ZP-BICN072ZE		—	x 2			



Zawias kątowy 30° KT
Corner hinge 30° KT
Угловая петля 30° KT

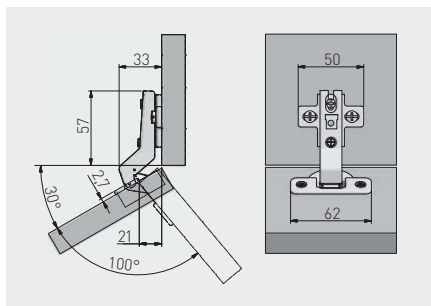

ZP-KT30H2-BE	H = 2	—	—	nikiel nickel нickedь	stal steel сталь	



Zawias kątowy 45° KT
 Corner hinge 45° KT
 Угловая петля 45° KT

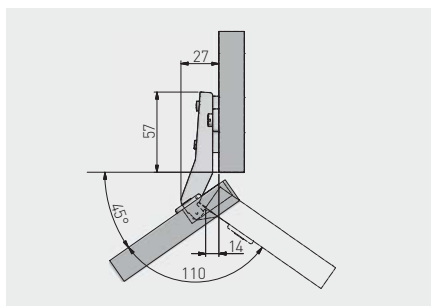

ZP-KT45H2-BE	H = 2	—	—	nikiel nickel никель	stal steel сталь
ZP-KT45H2-ZE		—	x 2		



Zawias równoległy KT
 Parallel hinge KT
 Петля под фальшпанель KT

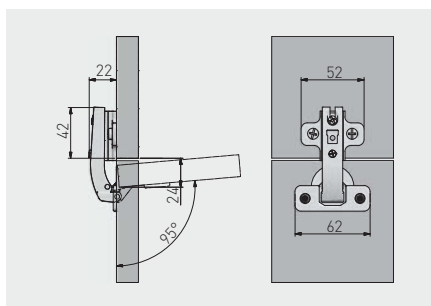

ZP-KT90H2-BE	H = 2	—	—	nikiel nickel никель	stal steel сталь
ZP-KT90H2-ZE		—	x 2		



Zawias równoległy – krótkie ramię KTK
 Parallel hinge – short arm KTK
 Петля под фальшпанель с коротким плечем КTK

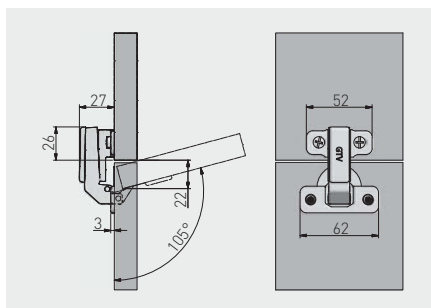

ZP-KTK90H6BE	H = 6	—	—	nikiel nickel никель	stal steel сталь
ZP-KTK90H6ZE		—	x 2		



Zawias równoległy nakładany – krótkie ramię KTKN
 Parallel hinge for overlay door – short arm KTKN
 Петля под фальшпанель с коротким плечем, накладная КTKN

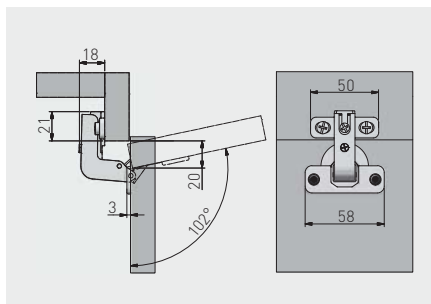

ZP-KTKN90H0-ZE	H = 0	—	x 2	nikiel nickel никель	stal, ZnAl steel, ZnAl сталь, ZnAl



Zawias 165° KT
Hinge 165° KT
Петля 165° KT

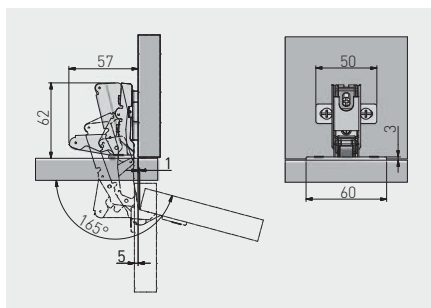

ZP-KT165H2BE	H = 2	—	—	nikiel nickel	stal steel
ZP-KT165H2ZE		—	x 2	nikiel nickel	stal steel



Zawias uzupełniający 135° KT
Complementary hinge 135° KT
Петля для складных дверей 135° KT

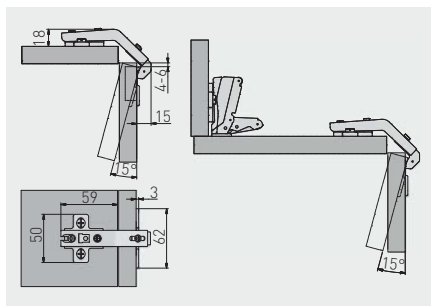

ZP-KT135H2BE	H = 2	—	—	nikiel nickel	stal, ZnAl steel, ZnAl
ZP-KT135H2ZE		—	x 2	nikiel nickel	stal, ZnAl steel, ZnAl



Zawias bez sprężyny COCA, nakładany
 Hinge without spring COCA, overlay door
 Петля без пружины COCA, накладная

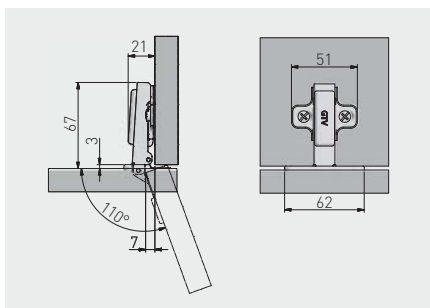

ZP-COCA450-BE	H = 0	—	—	nikiel nickel нickedь	stal steel сталь
ZP-COCA450-ZE		—	x 2		



Zawias bez sprężyny COCA, wpuszczany
 Hinge without spring COCA, inset door
 Петля без пружины COCA, внутренняя

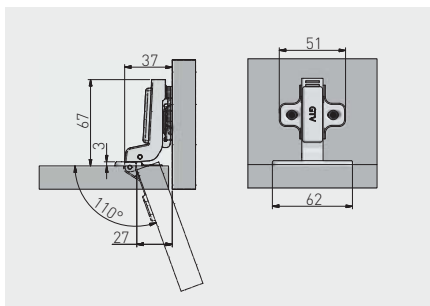

ZP-COCA7450-BE	H = 0	—	—	nikiel nickel нickedь	stal steel сталь



Zawias samootwierający PO, nakładany
 Self-opening hinge PO, overlay door
 Петля самооткрывающаяся PO, накладная

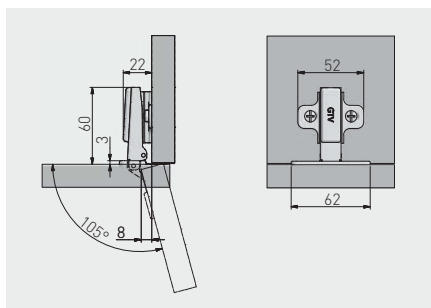

ZP-POH045BE0	H = 0	—	—	nikiel nickel никель	stal steel сталь
ZP-POH045ZE0		—	x 2		



Zawias samootwierający PO, wpuszczany
 Self-opening hinge PO, inset door
 Петля самооткрывающаяся PO, внутренняя

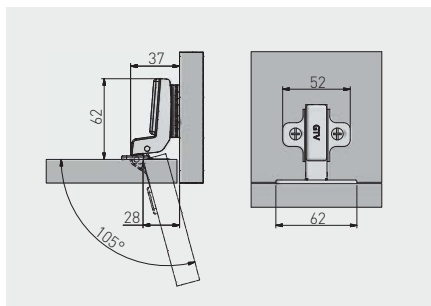

ZP-PO7H045BE	H = 0	—	—	nikiel nickel никель	stal steel сталь



Zawias hydrauliczny mini CIHC, nakładany
 Hydraulic hinge mini CIHC, overlay door
 Гидравлическая петля мини CIHC, накладная

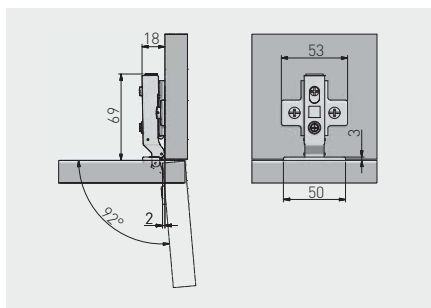

ZP-CIHC090ZE	H = 0	-	x 2	nikiel nickel нικель	stal, ZnAl / steel, ZnAl / сталь, ZnAl



Zawias hydrauliczny mini CIHC, bliźniaczy
 Hydraulic hinge mini CIHC, twin overlay door
 Гидравлическая петля мини CIHC, полунакладная

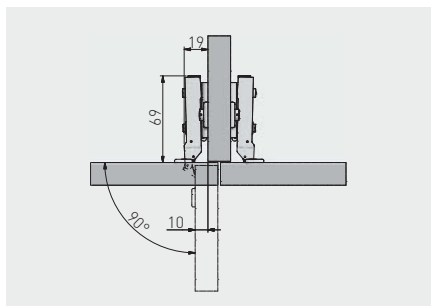

ZP-CIHC080ZE	H = 0	-	x 2	nikiel nickel нικель	stal, ZnAl / steel, ZnAl / сталь, ZnAl



Zawias hydrauliczny mini CIHC, wpuszczany
 Hydraulic hinge mini CIHC, inset door
 Гидравлическая петля мини CIHC, внутренняя

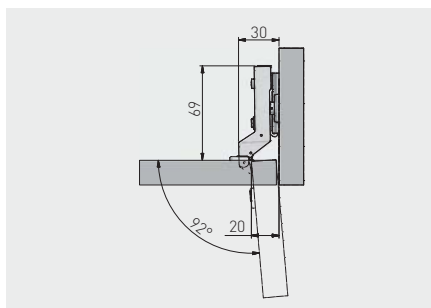

ZP-CIHC070ZE	H = 0	-	x 2	nikiel nickel нικель	stal, ZnAl / steel, ZnAl / сталь, ZnAl



Zawias mini CIBI, nakładany
 Hinge mini CIBI, overlay door
 Петля мини CIBI, накладная

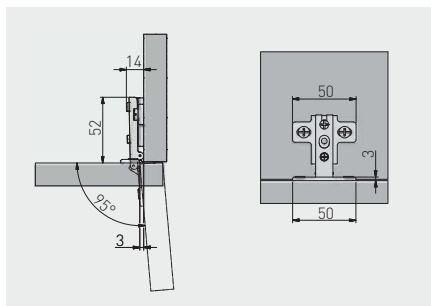

ZP-CIBI9H0ZE	H = 0	-	x 2	nikiel / nickel / никель	stal / steel / сталь



Zawias mini CIBI, bliźniaczy
Hinge mini CIBI, twin overlay door
Петля мини CIBI, полунакладная

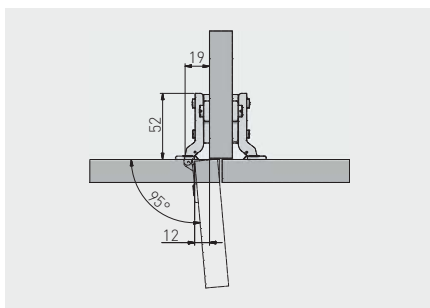

ZP-CIBI8H0ZE	H = 0	-	x 2	nikiel nickel никель	stal steel сталь



Zawias mini CIBI, wpuszczany
Hinge mini CIBI, inset door
Петля мини CIBI, внутренняя

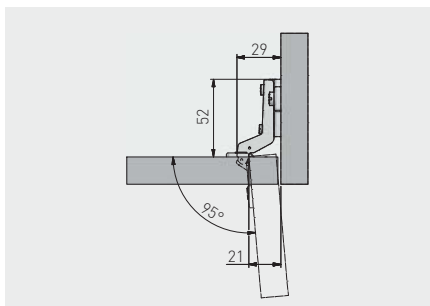

ZP-CIBI7H0ZE	H = 0	-	x 2	nikiel nickel никель	stal steel сталь



Zawias do szkła CIG, nakładany
Hinge for glass CIG, overlay door
Петля для стеклянных дверей CIG, накладная

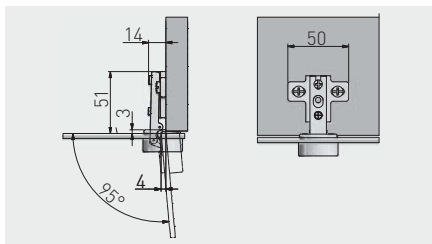

ZP-CIG-090ZE	H = 0	—	x 2	nikiel nickel нicked	stal, tworzywo steel, plastic сталь, пластмасса		chrom / chrome / хром	
ZP-CIG-09UZE		—	x 2					
ZP-CIG-09UBE		—	—				czarny / black / чёрный	
ZP-CIG-09UZE		—	x 2					
ZP-CIG-190ZE		—	x 2					aluminium aluminium алюминий
ZP-CIG-19UZE		—	x 2					



Zawias do szkła CIG, wpuszczany
Hinge for glass CIG, inset door
Петля для стеклянных дверей CIG, внутренняя

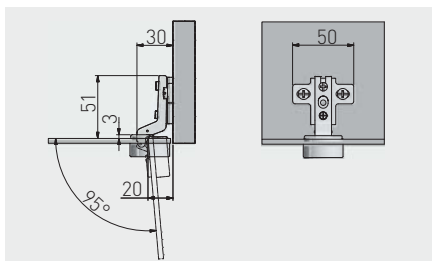

ZP-CIG-070ZE	H = 0	—	x 2	nikiel nickel нicked	stal, tworzywo steel, plastic сталь, пластмасса		chrom chrome хром	
ZP-CIG-07UZE		—	x 2					
ZP-CIG-170ZE		—	x 2				aluminium aluminium алюминий	
ZP-CIG-17UZE		—	x 2					



Zawias do ramek aluminiowych, nakładany
 Hinge for aluminium frames, overlay door
 Петля GTV для алюминиевых рамок, с клипом, накладная

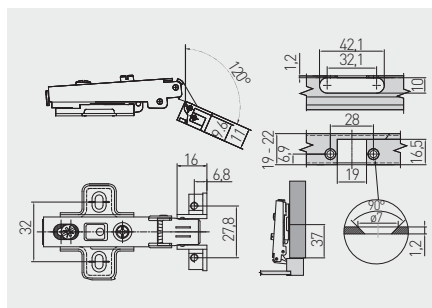

Produkt kompatybilny: profil aluminiowy do frontów: PA-3731-35-50
 Product compatible with aluminum profile for fronts: PA-3731-35-50
 Подходит для алюминиевых профилей под индексом: PA-3731-35-50

ZP-RALUH2-00	H = 2	—	—	nikiel nickel никель	stal steel сталь



Zawias hydrauliczny do ramek aluminiowych, nakładany
 Hinge for aluminium frame, overlay door
 Петля GTV для алюминиевых рамок, с клипом, накладная

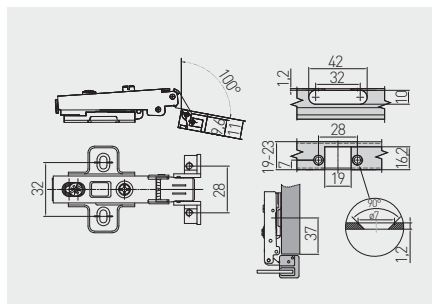

Produkt kompatybilny: profil aluminiowy do frontów: PA-3731-35-50
 Product compatible with aluminum profile for fronts: PA-3731-35-50
 Подходит для алюминиевых профилей под индексом: PA-3731-35-50

ZM-HCRALU9BE	H = 0	—	—	nikiel nickel никель	stal steel сталь



Zawias 270°, nakładany
Hinge 270°, overlay door
Петля 270°, накладная

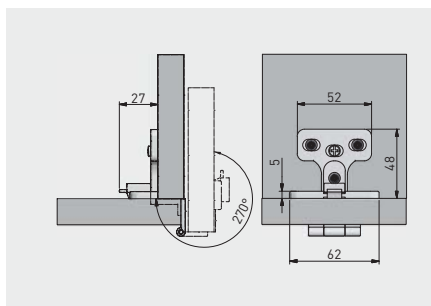

ZP-KT0270-BE	—	—	nikiel nickel ннкель	ZnAl



Zawias tłoczkowy duży
Cylinder hinge large
Поршневая петля (большая)

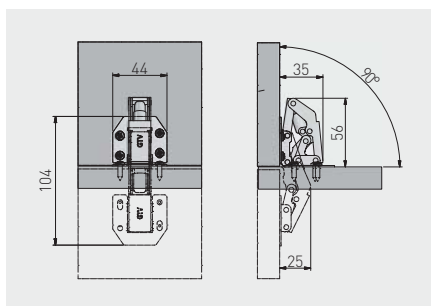

ZT-HF-01-D00	—	—	nikiel nickel ннкель	stal steel сталь



Zawias tłoczkowy mały
 Cylinder hinge small
 Поршневая петля (малая)

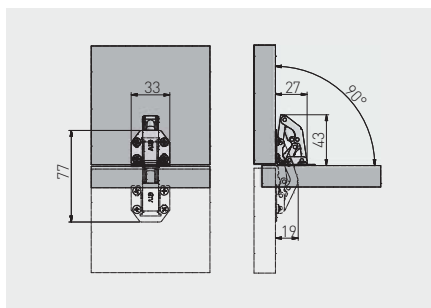

ZT-HF-01-M00	—	—	nikiel nickel никель	stal steel сталь



Zawias JUNIOR 75°
 JUNIOR hinge 75°
 Петля JUNIOR 75°

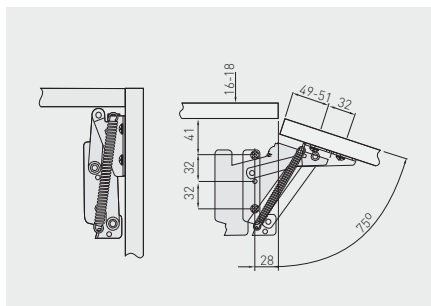

ZP-JUNIOR-00	—	—	nikiel nickel никель	stal steel сталь



Zawias skrzydełkowy
Butterfly hinge
Петля-бабочка

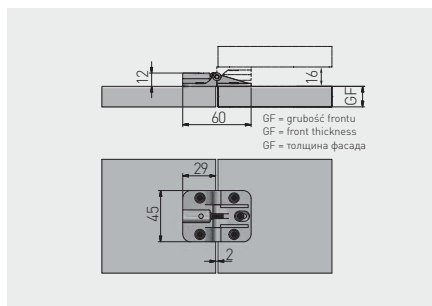

ZP-SKR-00-80	—	—	lakier lacquer лак	szary gray серый	ZnAl



Zawias cylindryczny
Cylinder hinge
Петля цилиндрическая

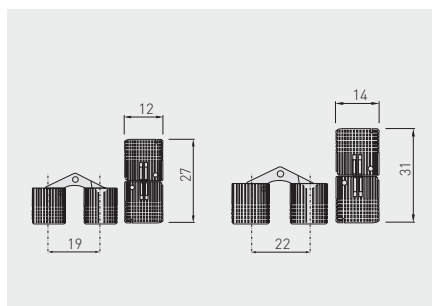

ZC-GTV-12-00	12	7	mosiądz brass латунь	mosiądz brass латунь
ZC-GTV-14-00	14			



Zawias barkowy
Flap hinge
Барная петля

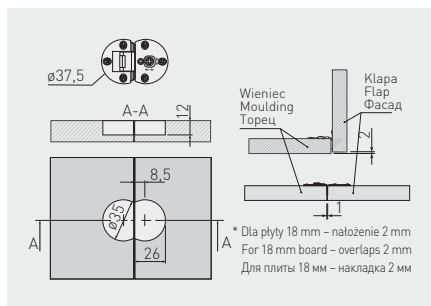

PD-MD-ZB-01-KPL	1 kpl. = 2 szt. 1 set = 2 pcs	chrom / chrome / хром	ZnAl
PD-MD-ZB-04-KPL	1 комп. = 2 шт.	antyczny mosiądz / antique brass / античная латунь	



Amortyzator z adapterem prostym
Buffer with straight adapter
Амортизатор с прямым адаптером

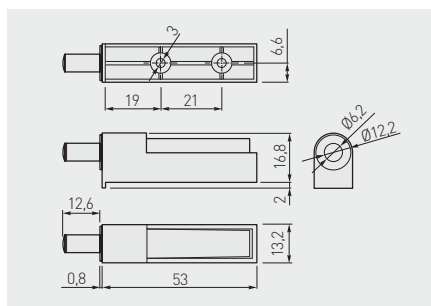

AM-PROST-KPL	szary gray серый	tworzywo plastic пластмасса



Amortyzator z adapterem krzyżakowym
 Buffer with cross adapter
 Амортизатор с крестовым адаптером

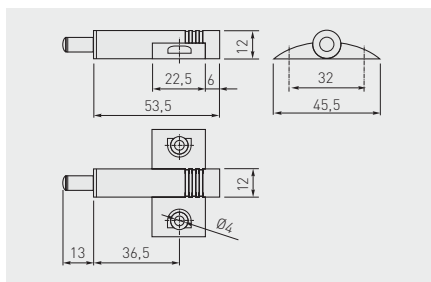

AM-KRZYZ-KPL	szary gray серый	tworzywo plastic пластмасса
--------------	------------------------	-----------------------------------



Amortyzator AM-ODB
 Buffer AM-ODB
 Амортизатор AM-ODB

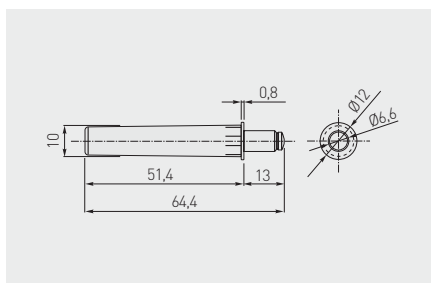

AM-ODB000-60	standard	szary / gray / серый	tworzywo / plastic / пластмасса
AM-ODB000-10		biały / white / белый	



Adapter AM-ODB prosty
 Adapter AM-ODB straight
 Адаптер AM-ODB прямой

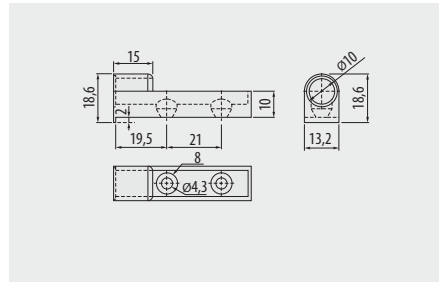

AM-ADAP0B-60	szary / gray / серый	tworzywo / plastic / пластмасса
AM-ADAP0B-10	biały / white / белый	



Adapter AM-ODB krzyżakowy
 Cross adapter AM-ODB
 Адаптер AM-ODB крестовой

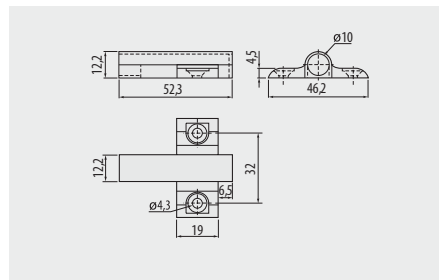

AM-ADAP0A-60	szary / gray / серый	tworzywo / plastic / пластмасса
AM-ADAP0A-10	biały / white / белый	



Odbojnik wpuszczany krótki
Bumper, recessed, short
Амортизатор врезной короткий

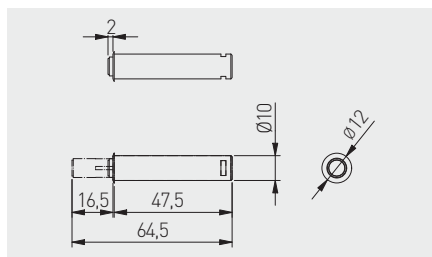

AM-OWM-KR-MG-10	z końcówką magnetyczną / magnetic tip / магнитный наконечник	biały white белый	tworzywo plastic пластмасса
AM-OWM-KR-GM-10	z końcówką kauczukową / with rubber tip / каучуковый наконечник		
AM-OWM-KR-MG-30	z końcówką magnetyczną / magnetic tip / магнитный наконечник	szary gray серый	
AM-OWM-KR-GM-30	z końcówką kauczukową / with rubber tip / каучуковый наконечник		
AM-OWM-KR-MG-60	z końcówką magnetyczną / magnetic tip / магнитный наконечник	antracyt anthracite антрацит	
AM-OWM-KR-GM-60	z końcówką kauczukową / with rubber tip / каучуковый наконечник		



Odbojnik wpuszczany długi
Bumper, recessed, long
Амортизатор врезной длинный

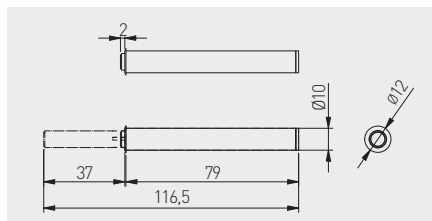

AM-OWM-DL-MG-10	z końcówką magnetyczną / magnetic tip / магнитный наконечник	biały white белый	tworzywo plastic пластмасса
AM-OWM-DL-GM-10	z końcówką kauczukową / with rubber tip / каучуковый наконечник		
AM-OWM-DL-MG-30	z końcówką magnetyczną / magnetic tip / магнитный наконечник	szary gray серый	
AM-OWM-DL-GM-30	z końcówką kauczukową / with rubber tip / каучуковый наконечник		
AM-OWM-DL-MG-60	z końcówką magnetyczną / magnetic tip / магнитный наконечник	antracyt anthracite антрацит	
AM-OWM-DL-GM-60	z końcówką kauczukową / with rubber tip / каучуковый наконечник		



Odbojnik krótki z adapterem Bumper, short, with adapter Амортизатор короткий с адаптером

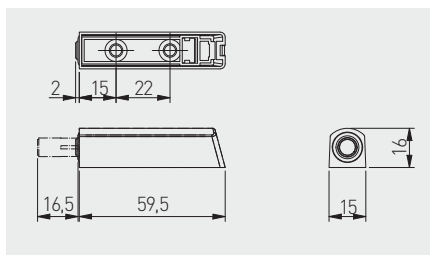

AM-OAM-KR-MG-10	z końcówką magnetyczną / magnetic tip / магнитный наконечник	biały white белый	tworzywo plastic пластмасса
AM-OAM-KR-GM-10	z końcówką kauczukową / with rubber tip / каучуковый наконечник		
AM-OAM-KR-MG-30	z końcówką magnetyczną / magnetic tip / магнитный наконечник	szary gray серый	
AM-OAM-KR-GM-30	z końcówką kauczukową / with rubber tip / каучуковый наконечник		
AM-OAM-KR-MG-60	z końcówką magnetyczną / magnetic tip / магнитный наконечник	antracyt anthracite антрацит	
AM-OAM-KR-GM-60	z końcówką kauczukową / with rubber tip / каучуковый наконечник		



Odbojnik długi z adapterem Bumper, long, with adapter Амортизатор длинный с адаптером

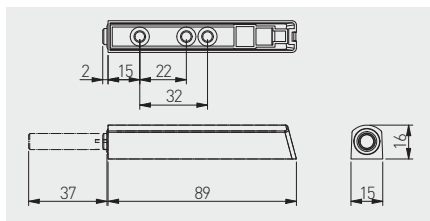





AM-OAM-DL-MG-10	z końcówką magnetyczną / magnetic tip / магнитный наконечник	biały white белый	tworzywo plastic пластмасса
AM-OAM-DL-GM-10	z końcówką kauczukową / with rubber tip / каучуковый наконечник		
AM-OAM-DL-MG-30	z końcówką magnetyczną / magnetic tip / магнитный наконечник	szary gray серый	
AM-OAM-DL-GM-30	z końcówką kauczukową / with rubber tip / каучуковый наконечник		
AM-OAM-DL-MG-60	z końcówką magnetyczną / magnetic tip / магнитный наконечник	antracyt anthracite антрацит	
AM-OAM-DL-GM-60	z końcówką kauczukową / with rubber tip / каучуковый наконечник		

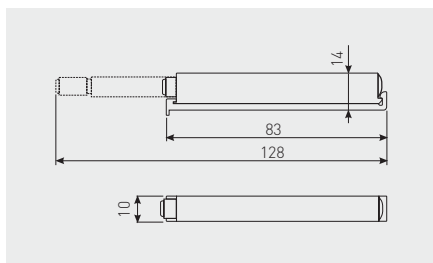

Odbojnik AM-PL z adapterem
Bumper with adapter AM-PL
Амортизатор с адаптером AM-PL



			
AM-PL-DL-MAG	z końcówką magnetyczną magnetic tip магнитный наконечник	szary gray серый	tworzywo plastic пластмасса
AM-PLA-DLU-0	z końcówką kauczukową with rubber tip каучуковый наконечник		



Odbojnik AM-ZAT zatraskowy
Push latch AM-ZAT
Амортизатор AM-ZAT на защелке

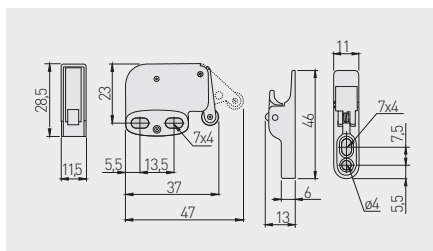

		
AM-ZAT-A1-10	biały white белый	stal, tworzywo steel, plastic сталь, пластмасса

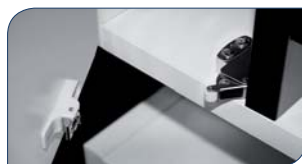



Do zastosowania z zawiasem samootwierającym ZP-POH045ZE0

Dedicated for GTV self opening hinge ZP-POH045ZE0

Используется с самооткрывающейся петлей ZP-POH045ZE0

Amortyzator silikonowy
Silicone damper dots
Амортизатор силиконовый





	 mm	
AMR-BP-1003	Ø10 x 3	100 szt. / arkusz 100 pcs / sheet
AMR-BP-0715	Ø7 x 1,5	100 шт. / лист

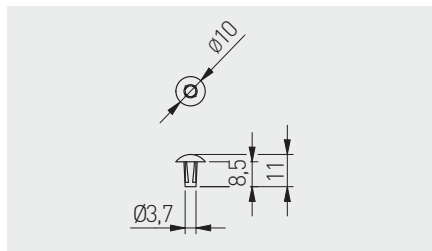

Amortyzator silikonowy wpuszczany
Silicone damper, recessed
Амортизатор силиконовый, врезной



	 mm	
AMR-WP-00	Ø5 x 3	silikon silicon кремний



Podnośnik TOP STAYS
TOP STAYS lift
Подъемник TOP STAYS

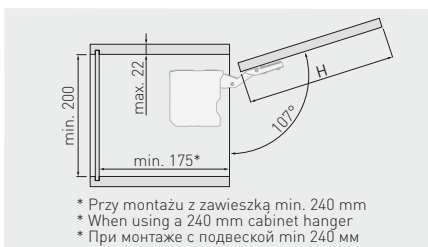



	Orientacyjna wysokość frontu Approximate front height Ориентировочная высота фасада	Współczynnik F Power Factor F Показатель F	Sprężyna Spring power Пружина		
PD-LIFT-LIGHT-10	250 – 400 mm	580 – 1250	light	biały / white / белый	stal steel сталь
PD-LIFT-LIGHT-80				szary / gray / серый	
PD-LIFT-MEDIUM-10	400 – 500 mm	960 – 2040	medium	biały / white / белый	
PD-LIFT-MEDIUM-80				szary / gray / серый	
PD-LIFT-STRONG-10	500 mm	1800 – 3500	strong	biały / white / белый	
PD-LIFT-STRONG-80				szary / gray / серый	

Współczynnik mocy F = wysokość frontu H (mm) × waga frontu łącznie z podwójną wagą uchwytu (kg)
Power Factor F = front height × front weight with doubled handle weight (kg)
Показатель мощности F = высота фасада H (мм) × вес фасада с удвоенным весом ручки (кг)

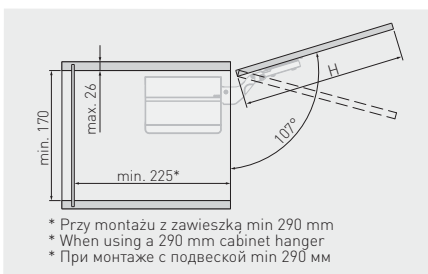
Podnośnik HEAVY DUTY
HEAVY DUTY lift
Подъемник HEAVY DUTY



	Wysokość frontu Front height Высота фасада	Współczynnik F Power Factor F Показатель F		
PD-LIFT-HEAVY_DUTY-10	400 – 700 mm	3200 – 9000	biały / white / белый	stal, tworzywo steel, plastic сталь, пластмасса
PD-LIFT-HEAVY_DUTY-80			szary / gray / серый	

Współczynnik mocy F = wysokość frontu H (mm) × waga frontu łącznie z podwójną wagą uchwytu (kg)
Power Factor F = front height H (mm) × front weight with doubled handle weight (kg)
Показатель мощности F = высота фасада H (мм) × вес фасада с удвоенным весом ручки (кг)

Podnośnik gazowy z amortyzatorem i regulacją

Gas stay with buffer, adjustable

Подъемник газовый с амортизатором и регулировкой

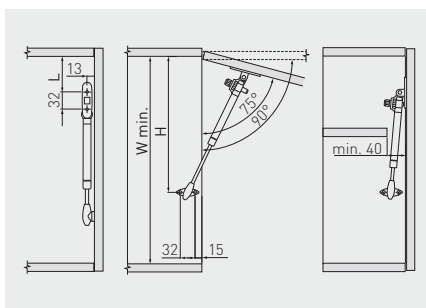

PD-GAM050-N02	50 N	szary gray серый	stal steel сталь
PD-GAM060-N02	60 N		
PD-GAM080-N02	80 N		
PD-GAM100-N02	100 N		
PD-GAM120-N02	120 N		
PD-GAM050-N10	50 N	biały white белый	
PD-GAM060-N10	60 N		
PD-GAM080-N10	80 N		
PD-GAM100-N10	100 N		
PD-GAM120-N10	120 N		
PD-GAM050-N60	50 N	antracyt anthracite антрацит	
PD-GAM060-N60	60 N		
PD-GAM080-N60	80 N		
PD-GAM100-N60	100 N		
PD-GAM120-N60	120 N		
PD-GAM150-N60	150 N		

Kąt otwarcia drzwi Door opening angle Угол открывания дверей	H (mm)	L (mm)	W (mm)
75°	295	64	315
90°	275	52	300



Kąt otwarcia drzwi Door opening angle Угол открывания дверей	Siła podnośnika Lift force Мощность подъемника	Wysokość drzwi (mm) / Door height (mm) / Высота дверцы (мм)			
		300	400	500	600
		Waga drzwi (kg) / Door weight (kg) / Вес дверцы (кг)			
 75°	50 N	1,6	1,2	1,0	0,8
	60 N	2,0	1,5	1,2	1,0
	80 N	2,7	2,0	1,6	1,4
	100 N	3,4	2,6	2,0	1,7
	120 N	4,1	3,1	2,5	2,0
150 N	4,7	3,5	2,9	2,4	
 90°	50 N	1,5	1,1	0,9	0,7
	60 N	1,8	1,3	1,1	0,9
	80 N	2,4	1,8	1,4	1,2
	100 N	3,0	2,2	1,8	1,5
	120 N	3,6	2,7	2,1	1,8
150 N	4,1	3,2	2,3	2,1	

Podnośnik gazowy z amortyzatorem
Gas stay with buffer
Подъемник газовый с амортизатором

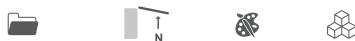

PD-GAMB050-N02	50 N	szary gray серый	stal, tworzywo steel, plastic сталь, пластмасса
PD-GAMB060-N02	60 N		
PD-GAMB080-N02	80 N		
PD-GAMB100-N02	100 N		
PD-GAMB120-N02	120 N		
PD-GAMB150-N02	150 N	biały white белый	
PD-GAMB050-N10	50 N		
PD-GAMB060-N10	60 N		
PD-GAMB080-N10	80 N		
PD-GAMB100-N10	100 N		
PD-GAMB120-N10	120 N		
PD-GAMB150-N10	150 N	antracyt anthracite антрацит	
PD-GAMB050-N60	50 N		
PD-GAMB060-N60	60 N		
PD-GAMB080-N60	80 N		
PD-GAMB100-N60	100 N		
PD-GAMB120-N60	120 N		
PD-GAMB150-N60	150 N		

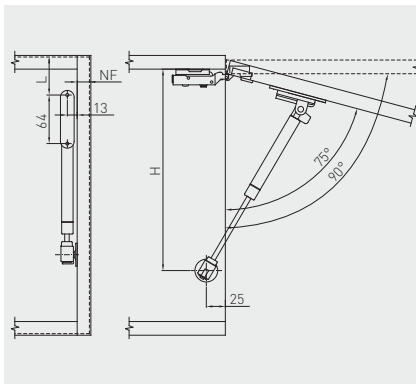

Kąt otwarcia drzwi Door opening angle Угол открывания дверей	H (mm)	L (mm)
75°	265	65
90°	245	50



Kąt otwarcia drzwi Door opening angle Угол открывания дверей	Siła podnośnika Lift force Мощность подъемника	Wysokość drzwi (mm) / Door height (mm) / Высота дверцы (мм)			
		300	400	500	600
		Waga drzwi (kg) / Door weight (kg) / Вес дверцы (кг)			
 75°	50 N	1.6	1.2	1.0	0.8
	60 N	2.0	1.5	1.2	1.0
	80 N	2.7	2.0	1.6	1.4
	100 N	3.4	2.6	2.0	1.7
	120 N	4.1	3.1	2.5	2.0
 90°	50 N	1.5	1.1	0.9	0.7
	60 N	1.8	1.3	1.1	0.9
	80 N	2.4	1.8	1.4	1.2
	100 N	3.0	2.2	1.8	1.5
	120 N	3.6	2.7	2.1	1.8
	150 N	4.1	3.2	2.3	2.1

Podnośnik gazowy standard
Gas stay lift standard
Подъемник газовый стандартный



PD-G0050-N02	50 N	szary gray серый	stal steel сталь
PD-G0060-N02	60 N		
PD-G0080-N02	80 N		
PD-G0100-N02	100 N		
PD-G0120-N02	120 N		
PD-G0150-N02	150 N		

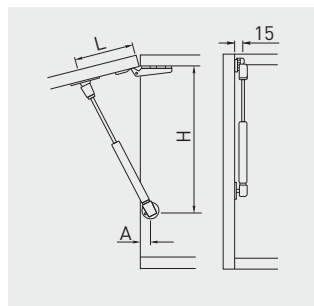

Kąt otwarcia drzwi Door opening angle Угол открывания дверей	Drzwi wpuszczane Inset door Внутренние дверцы			Drzwi bliźniacze Twin door Двойные дверцы			Drzwi nakładane Overlay door Наружные дверцы		
	H (mm)	L (mm)	A (mm)	H (mm)	L (mm)	A (mm)	H (mm)	L (mm)	A (mm)
75°	280	100	20 + grubość frontu 20 + front thicknes 20 + толщина фронта	272	100	25	264	100	25
90°	260	90		251	90	25	244	90	25
100°	250	80		242	80	25	234	80	25

Kąt otwarcia drzwi Door opening angle Угол открывания дверей	Siła podnośnika Lift force Мощность подъемника	Wysokość drzwi (mm) / Door height (mm) / Высота дверцы (мм)			
		300	400	500	600
		Waga drzwi (kg) / Door weight (kg) / Вес дверцы (кг)			
75°	60 N	2,0	1,5	1,2	1,0
	80 N	2,7	2,0	1,6	1,4
	100 N	3,4	2,6	2,0	1,7
	120 N	4,1	3,1	2,5	2,0
	150 N	4,7	3,5	2,9	2,4
90°	60 N	1,8	1,3	1,1	0,9
	80 N	2,4	1,8	1,4	1,2
	100 N	3,0	2,2	1,8	1,5
	120 N	3,6	2,7	2,1	1,8
	150 N	4,1	3,2	2,3	2,1
100°	60 N	1,6	1,2	0,9	0,8
	80 N	2,1	1,6	1,2	1,0
	100 N	2,6	1,9	1,6	1,3
	120 N	3,1	2,3	1,9	1,6
	150 N	3,5	2,6	2,2	1,9

Podnośnik gazowy krótki
Gas stay lift short
Подъемник газовый короткий

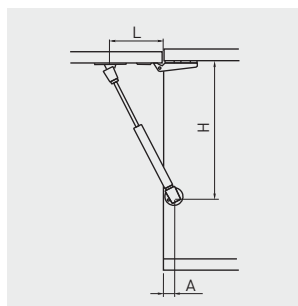

PD-G60160-02	60 N	szary gray серый	stal steel сталь
PD-G80160-02	80 N		



Kąt otwarcia drzwi Door opening angle Угол открывания дверей	Drzwi wpuszczane Inset door Внутренние дверцы			Drzwi bliźniacze Twin door Двойные дверцы			Drzwi nakładane Overlay door Наружные дверцы		
	H (mm)	L (mm)	A (mm)	H (mm)	L (mm)	A (mm)	H (mm)	L (mm)	A (mm)
75°	188	70	20 + grubość frontu 20 + front thickness 20 + толщина фронта	180	70	20	172	70	20
90°	176	60		167	60	20	160	60	20
100°	172	50		164	50	20	154	50	20

Kąt otwarcia drzwi Door opening angle Угол открывания дверей	Siła podnośnika Lift force Мощность подъемника	Wysokość drzwi (mm) / Door height (mm) / Высота дверцы (мм)			
		300	400	500	600
		Waga drzwi (kg) / Door weight (kg) / Вес дверцы (кг)			
75° 	60 N	2,0	1,5	1,2	1,0
	80 N	2,7	2,0	1,6	1,4
90° 	60 N	1,8	1,3	1,1	0,9
	80 N	2,4	1,8	1,4	1,2
100° 	60 N	1,6	1,2	0,9	0,8
	80 N	2,1	1,6	1,2	1,0

Podnośnik DESIGN mechaniczny
 Mechanical stay lift DESIGN
 Подъемник механический DESIGN



PD-GPD01-001	chrom / chrome / хром	stal steel
PD-GPD02-002	satyna / satin / сатин	stal сталь
PD-GPD03-005	aluminium / алюминий	



Podnośnik do klap
 Flap lift
 Подъемник фасада



100°

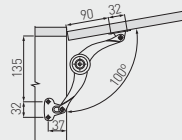

Plaszczyna wewn. boku
 Inner side surface
 Поверхность боковой стенки

Podnośnik do klap
 Flap lift
 Подъемник фасада



75°

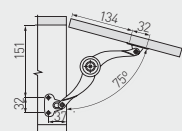

Plaszczyna wewn. boku
 Inner side surface
 Поверхность боковой стенки

Podnośnik do klap
 Flap lift
 Подъемник фасада



90°

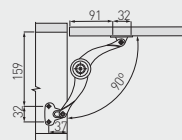

Plaszczyna wewn. boku
 Inner side surface
 Поверхность боковой стенки

Wizualizacja dla zawiasów barkowych
 Drop Down Flap Stay
 Визуализация для барных петель



90°

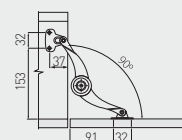

Plaszczyna wewn. boku
 Inner side surface
 Поверхность боковой стенки

Wykres orientacyjnych wartości
 maksymalnego ciężaru w zależności
 od wysokości klap.

Maximum weight depending
 on the flap height.

Максимальный вес фасада зависит
 от его высоты.

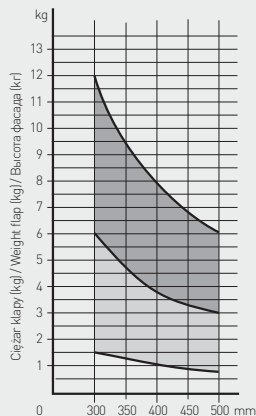
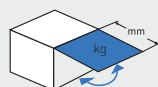

Wysokość kłapy (mm)
 Flap height (mm)
 Высота фасада (mm)

- 1 podnośnik
1 stay lift
1 подъемник
- 2 podnośniki
2 stay lifts
2 подъемника

Podnośnik mechaniczny standard
 Mechanical stay lift standard
 Подъемник механический стандартный



PD-PD000-001



chrom / chrome / хром



stal / steel / сталь

x 25



Podnośnik do klap
 Flap lift
 Поддержка фасада



100°

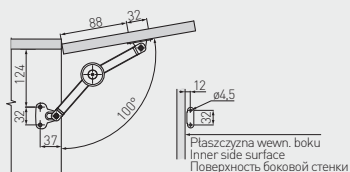

Podnośnik do klap
 Flap lift
 Поддержка фасада



75°

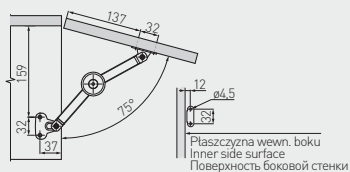

Podnośnik do klap
 Flap lift
 Поддержка фасада



90°

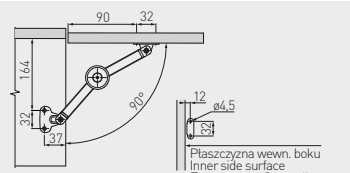

Rozwórka do klap
 Wizualizacja dla zawiasu barkowego
 Drop down flap stay
 Поддержка фасада
 Визуализация для барных петель



90°

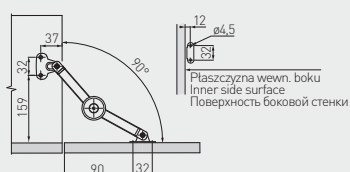

Wykres orientacyjnych wartości maksymalnego ciężaru w zależności od wysokości kłapy.

Maximum weight depending on the flap height.

Максимальный вес фасада зависит от его высоты.

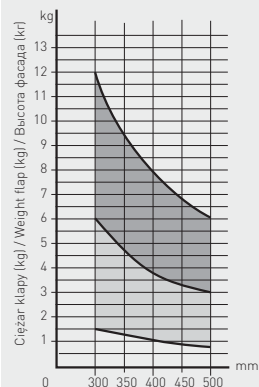
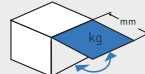

Wysokość kłapy (mm)
 Flap height (mm)
 Высота фасада (мм)

- 1 podnośnik
1 stay lift
1 подъемник
- 2 podnośniki
2 stay lifts
2 подъемника

Amortyzator VIM do kłap barkowych, krótki
 VIM stay lift for drop down cabinet doors, short
 Амортизатор барный, короткий VIM



Produkt kompatybilny z zawiasem barkowym: PD-MD-ZB
 Compatible with flap hinge: PD-MD-ZB

Продукт совместим с барной петлей: PD-MD-ZB

		
PD-MDLIFT-P1-D	szary gray серый	stal steel сталь



Orientacyjna tabela wartości doboru podnośników, w zależności od szerokości i wysokości kłapy.
 Maximum weight depending on the flap height.
 Таблица подбора амортизатора в зависимости от ширины и высоты фасада.

Wysokość Height Высота	Szerokość (mm) / Width (mm) / Ширина (мм)			
	600 mm	700 mm	800 mm	900 mm
	Ilość amortyzatorów Number of lifts Количество амортизаторов			
250 mm	1	1	2	2
260 mm				
270 mm				
280 mm				
290 mm				
300 mm	2	2	2	
310 mm				
320 mm				
330 mm				
340 mm				

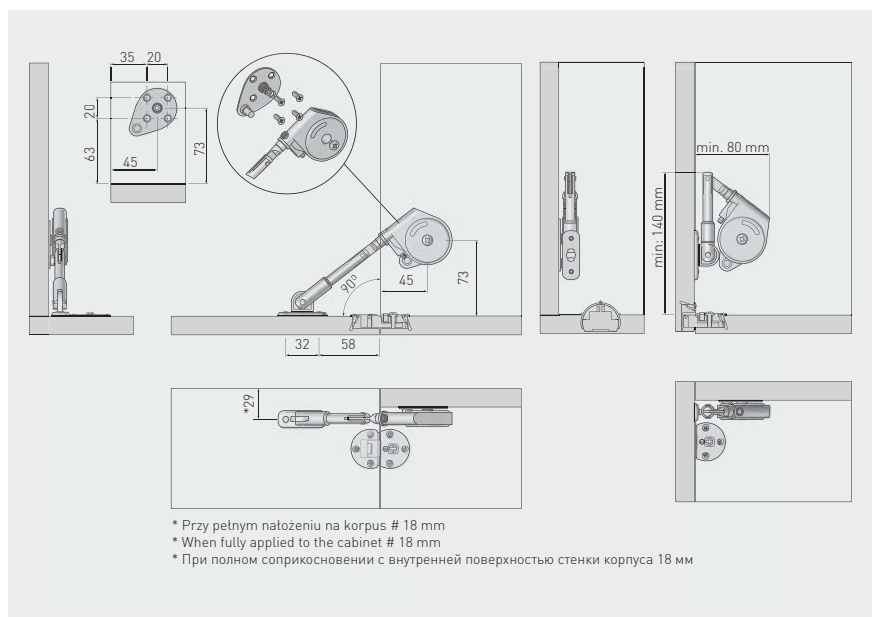

Amortyzator VIM do klap barkowych, długi
 VIM stay lift for drop down cabinet doors, long
 Амортизатор барный VIM, длинный



Produkt kompatybilny z zawiasem barkowym: PD-MD-ZB

Compatible with flap hinge: PD-MD-ZB

Продукт совместим с барной петлей: PD-MD-ZB

		
PD-MDLIFT-P2-D	szary gray серый	stal steel сталь



Orientacyjna tabela wartości doboru podnośników, w zależności od szerokości i wysokości kłapy.
 Maximum weight depending on the flap height.
 Таблица подбора амортизатора в зависимости от ширины и высоты фасада.

Wysokość Height Высота	Szerokość / Width / Ширина			
	600 mm	700 mm	800 mm	900 mm
	Ilość amortyzatorów Number of lifts Количество амортизаторов			
350 mm				
360 mm				
370 mm	1	2	2	2
380 mm				
390 mm				
400 mm				

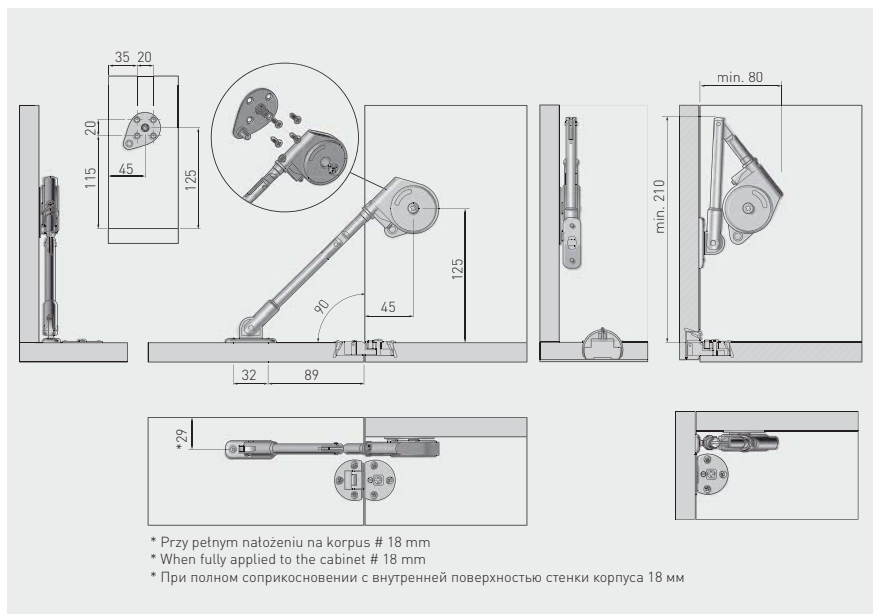

Amortyzator olejowy do klap barkowych
 Oil stay lift for drop down cabinet doors
 Амортизатор маслянный барный

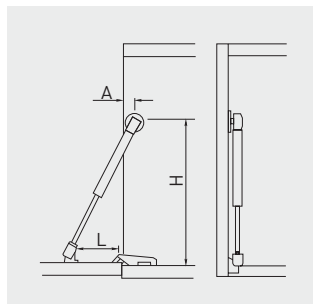

PD-ECGDL-060	60 N	szary gray серый	stal steel сталь
PD-ECGDL-080	80 N		
PD-ECGDL-150	150 N		



Kąt otwarcia drzwi Door opening angle Угол открывания дверей	Drzwi wpuszczane Inset door Внутренние дверцы			Drzwi bliźniacze Twin door Двойные дверцы			Drzwi nakładane Overlay door Наружные дверцы		
	H (mm)	L (mm)	A (mm)	H (mm)	L (mm)	A (mm)	H (mm)	L (mm)	A (mm)
90°	260	90	45	253	90	25	246	90	25

Kąt otwarcia drzwi Door opening angle Угол открывания дверей	Siła podnośnika Lift force Мощность подъемника	Wysokość drzwi (mm) / Door height (mm) / Высота дверцы (мм)			
		300	400	500	600
		Waga drzwi (kg) / Door weight (kg) / Вес дверцы (кг)			
 90°	60 N	1,8	1,3	1,1	0,9
	80 N	2,4	1,8	1,4	1,2
	150 N	4,1	3,2	2,3	2,1

Prowadnica dolnego montażu ze spowalniaczem OSHX

Undermount drawer slide with soft closing OSHX

Направляющая нижнего монтажа полного выдвижения с доводчиком OSHX



Rozstaw otworów montażowych
Mounting dimensions
Монтажные отверстия

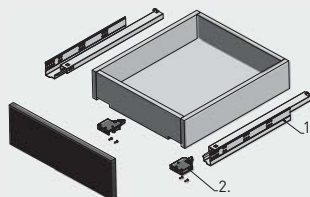
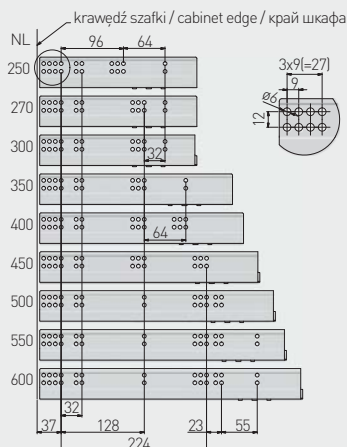



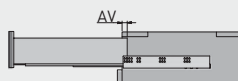



1. prowadnica lewa/prawa
drawer slide L/R
направляющая Л/П
2. sprzęgło lewe/prawe + wkręty
locking device L/R + screws
крепления фасада Л/П + саморезы



NL = długość nominalna prowadnicy
nominal slide length
номинальная длина направляющей

AV = strata wysuwu
extension loss
потеря на выдвигении

Uwagi montażowe: dla prawidłowego działania szuflady jej szerokość nie może przekraczać długości nominalnej prowadnicy.
Mounting information: for proper drawer operation, the width of the drawer can not exceed the nominal slide length.
Техническое примечание: ширина ящика не должна превышать длину направляющей.

		 L mm	 AV mm		 kg		
PB-0SHX-250-A		250	16	petny full полное	35	ocynk galvanized гальваника	stal steel сталь
PB-0SHX-270-A		270					
PB-0SHX-300-A		300					
PB-0SHX-350-A		350					
PB-0SHX-400-A		400					
PB-0SHX-450-A		450					
PB-0SHX-500-A		500					
PB-0SHX-550-A		550					
PB-0SHX-600-A		600					



Prowadnica dolnego montażu ze spowalniczem 0SHX-18
 Undermount drawer slide with soft closing 0SHX-18
 Направляющая нижнего монтажа с доводчиком 0SHX-18



Rozstaw otworów montażowych
 Mounting dimensions
 Монтажные отверстия

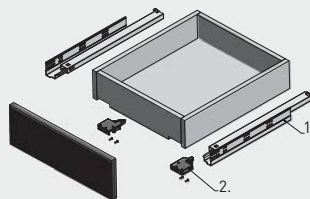
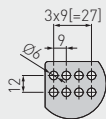
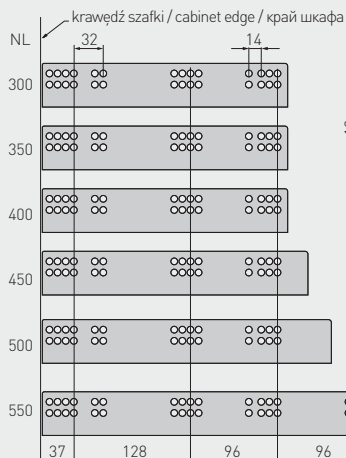

1. prowadnica lewa/prawa
 drawer slide L/R
 направляющая Л/П
2. sprzętło lewa/prawe + wkręty
 locking device L/R + screws
 крепления фасада Л/П + саморезы

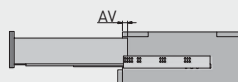

NL = długość nominalna prowadnicy
 nominal slide length
 номинальная длина направляющей

AV = strata wysuwu
 extension loss
 потеря на выдвигении

Uwagi montażowe: dla prawidłowego działania szuflady jej szerokość nie może przekraczać długości nominalnej prowadnicy.
 Mounting information: for proper drawer operation, the width of the drawer can not exceed the nominal slide length.
 Техническое примечание: ширина ящика не должна превышать длину направляющей.

	L mm	AV mm		kg		
PB-0SHX18-300-H	300	16	pełny full полное	30	ocynk galvanized гальваника	stal steel сталь
PB-0SHX18-350-H	350					
PB-0SHX18-400-H	400					
PB-0SHX18-450-H	450					
PB-0SHX18-500-H	500					
PB-0SHX18-550-H	550					



Prowadnica dolnego montażu ze spowalniczem 0SHX-18 3D
 Undermount drawer slide with soft closing 0SHX-18 3D
 Направляющая нижнего монтажа с доводчиком 0SHX-18 3D



NL krawędź szafka / cabinet edge / край шкафа

3x9(=27)
9
12

1. prowadnica lewa/prawa
drawer slide L/R
направляющая Л/П
2. sprzętło lewe/prawe + wkręty
locking device L/R + screws
крепления фасада Л/П + саморезы

AV

NL = długość nominalna prowadnicy
nominal slide length
номинальная длина направляющей

AV = strata wysuwu
extension loss
потеря на выдвигении

Uwagi montażowe: dla prawidłowego działania szuflady jej szerokość nie może przekraczać długości nominalnej prowadnicy.
 Mounting information: for proper drawer operation, the width of the drawer can not exceed the nominal slide length.
 Техническое примечание: ширина ящика не должна превышать длину направляющей.

	L mm	AV mm		kg		
PB-3D0SHX18-300-H	300	16	pełny full полное	30	ocynk galvanized гальваника	stal steel сталь
PB-3D0SHX18-350-H	350					
PB-3D0SHX18-400-H	400					
PB-3D0SHX18-450-H	450					
PB-3D0SHX18-500-H	500					
PB-3D0SHX18-550-H	550					



Prowadnica dolnego montażu ze spowalniczem GCHX

Undermount drawer slide with soft closing GCHX

Направляющая нижнего монтажа неполного выдвижения с доводчиком GCHX



krawędź szafki / cabinet edge / край шкафа

NL	96	32
250		
270		
300		
350		
400		32
450		64
500		
550		
600	96	
	128	
	224	
		23
		55

3x9(=27)
ø6
12







1. prowadnica lewa/prawa
drawer slide L/R
направляющая Л/П
2. sprzętło lewe/prawe + wkręty
locking device L/R + screws
крепления фасада Л/П + саморезы

AV

NL = długość nominalna prowadnicy
nominal slide length
номинальная длина направляющей

AV = strata wysunięciu
extension loss
потеря на выдвижении

Uwagi montażowe: dla prawidłowego działania szuflady jej szerokość nie może przekraczać długości nominalnej prowadnicy.
Mounting information: for proper drawer operation, the width of the drawer can not exceed the nominal slide length.
Техническое примечание: ширина ящика не должна превышать длину направляющей.

		 L mm	 AV mm		 kg 1		
PB-GCHX-250		250	98,5	niepełny partial неполное	25	ocynk galvanized гальваника	stal steel сталь
PB-GCHX-270		270					
PB-GCHX-300		300					
PB-GCHX-350		350					
PB-GCHX-400		400	118,5				
PB-GCHX-450		450					
PB-GCHX-500		500	138,5				
PB-GCHX-550		550					
PB-GCHX-600		600					



Prowadnica dolnego montażu ze spowalniaczem GCHX-H

Undermount drawer slide with soft closing GCHX-H

Направляющая нижнего монтажа неполное выдвигание с доводчиком GCHX-H

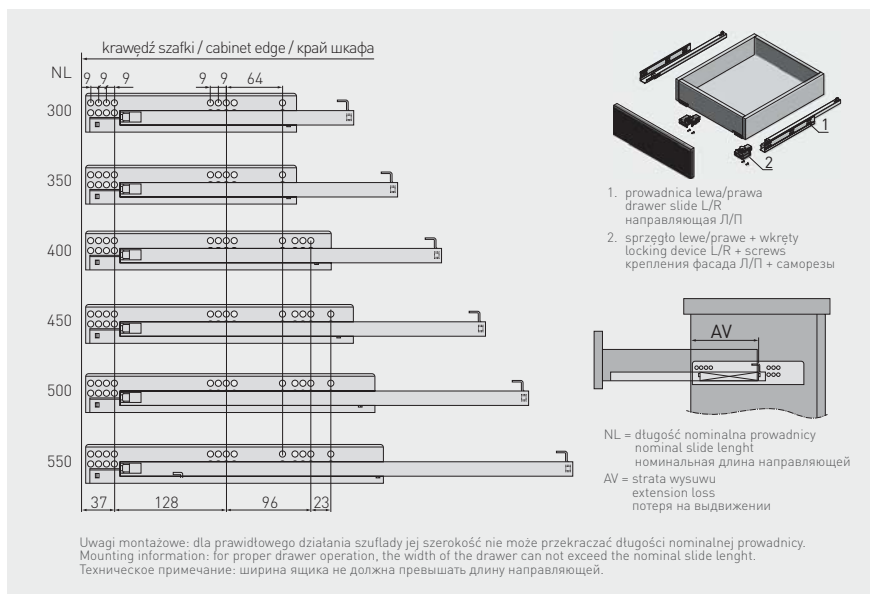

	L mm	AV mm		kg		
PB-GCHX-300-H	300	83	niepełny partial неполное	30	ocynk galvanized гальваника	stal steel сталь
PB-GCHX-350-H	350					
PB-GCHX-400-H	400	111				
PB-GCHX-450-H	450					
PB-GCHX-500-H	500					
PB-GCHX-550-H	550					



Prowadnica dolnego montażu push to open GAPO
 Undermount drawer slide push to open GAPO
 Направляющая нижнего монтажа неполное выдвижение push to open GAPO

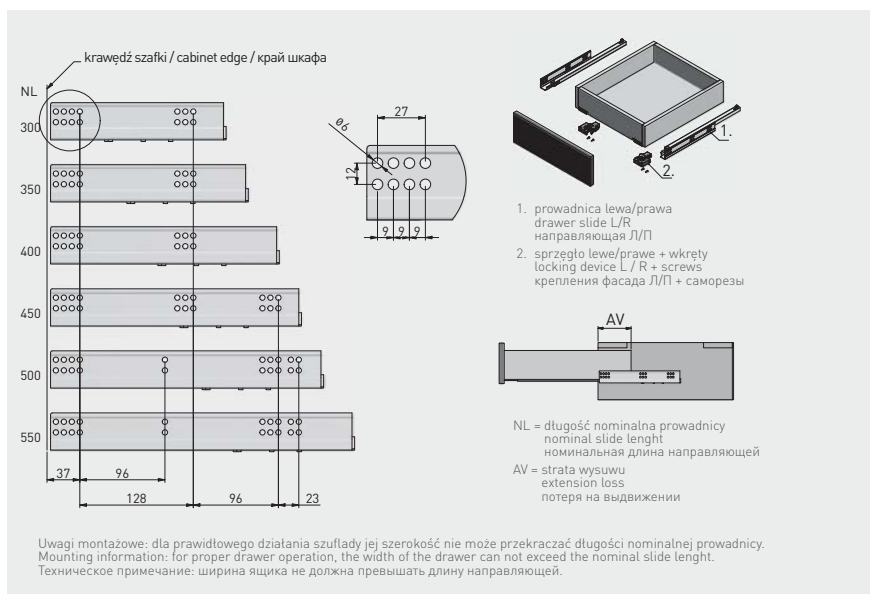

	L mm	AV mm				
PB-GAPO-300	300	98,5	niepełny partial неполное	25	ocynk galvanized гальваника	stal steel сталь
PB-GAPO-350	350					
PB-GAPO-400	400					
PB-GAPO-450	450					
PB-GAPO-500	500					
PB-GAPO-550	550	138,5				



Prowadnica dolnego montażu push to open 0FPO
 Undermount drawer slide push to open 0FPO
 Направляющая нижнего монтажа push to open 0FPO



Możliwość zastosowania stabilizatora PB-D-P20STAB
 Can be used with stabilizer PB-D-P20STAB
 Возможность использования стабилизатора PB-D-P20STAB

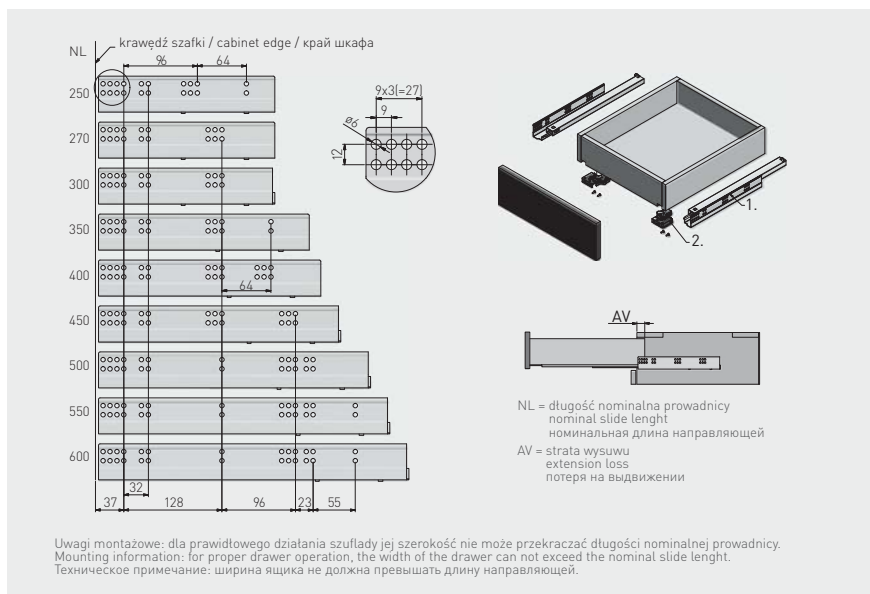

	L mm	AV mm	kg		
PB-0FPO-250	250	26	25	ocynk galvanized гальваника	stal steel сталь
PB-0FPO-270	270				
PB-0FPO-300	300				
PB-0FPO-350	350				
PB-0FPO-400	400				
PB-0FPO-450	450				
PB-0FPO-500	500				
PB-0FPO-550	550				
PB-0FPO-600	600				



Prowadnica dolnego montażu ze spowalniczem S10C
 Undermount drawer slide with soft closing S10C
 Направляющая нижнего монтажа с доводчиком S10C



Kotek blokujący (zabezpieczenie przed wypadnięciem szuflady)

Blocking peg (prevents drawer from falling out)

Ограничитель (защита от выпадения ящика)

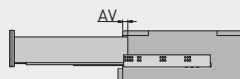
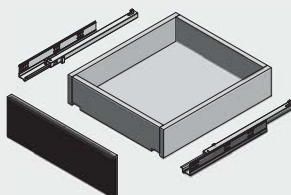
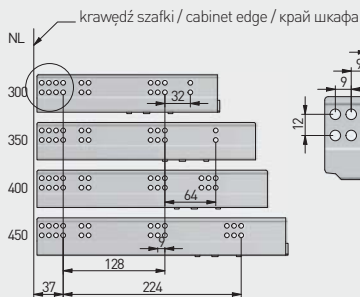

NL = długość nominalna prowadnicy
 nominal slide length
 номинальная длина направляющей

AV = strata wysuwu
 extension loss
 потеря на выдвигении

Uwagi montażowe: dla prawidłowego działania szuflady jej szerokość nie może przekraczać długości nominalnej prowadnicy.
 Mounting information: for proper drawer operation, the width of the drawer can not exceed the nominal slide length.
 Техническое примечание: ширина ящика не должна превышать длину направляющей.

		 L mm	 AV mm				
PB-S10C300HX		300	28	pełny full полное	25	ocynk galvanized гальваника	stal steel сталь
PB-S10C350HX		350					
PB-S10C400HX		400					
PB-S10C450HX		450					









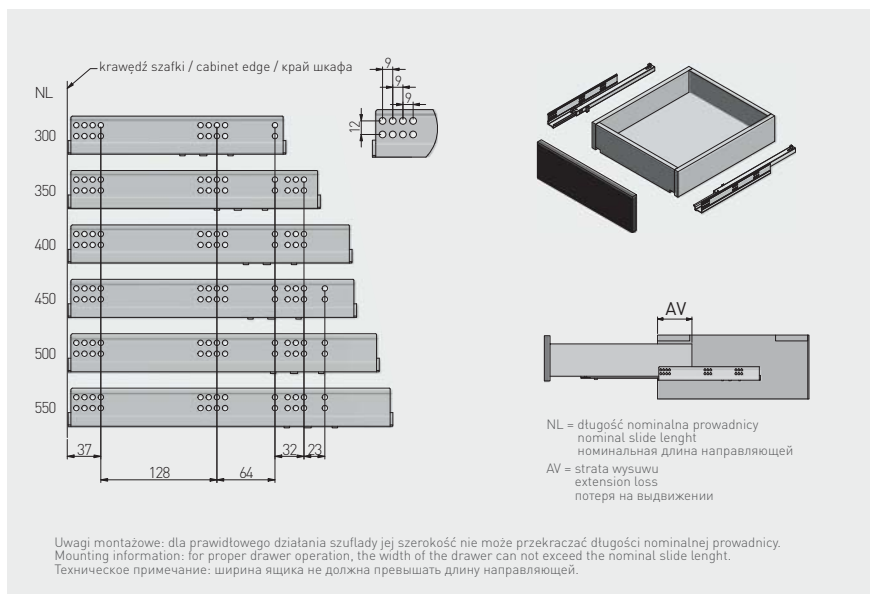

Prowadnice dolnego montażu ze spowalniaczem G10HX-H

Undermount drawer slide with soft closing G10HX-H

Направляющая нижнего монтажа неполное выдвижение с доводчиком G10HX-H

NEW



	 L mm	 AV mm		 kg		
PB-G10HX300-H	300	83	niepełny partial неполное	25	ocynk galvanized гальваника	stal steel сталь
PB-G10HX350-H	350					
PB-G10HX450-H	450	111				
PB-G10HX500-H	500					
PB-G10HX550-H	550					





Prowadnica kulkowa H53
Ball bearing slide H53
Шариковая направляющая H53

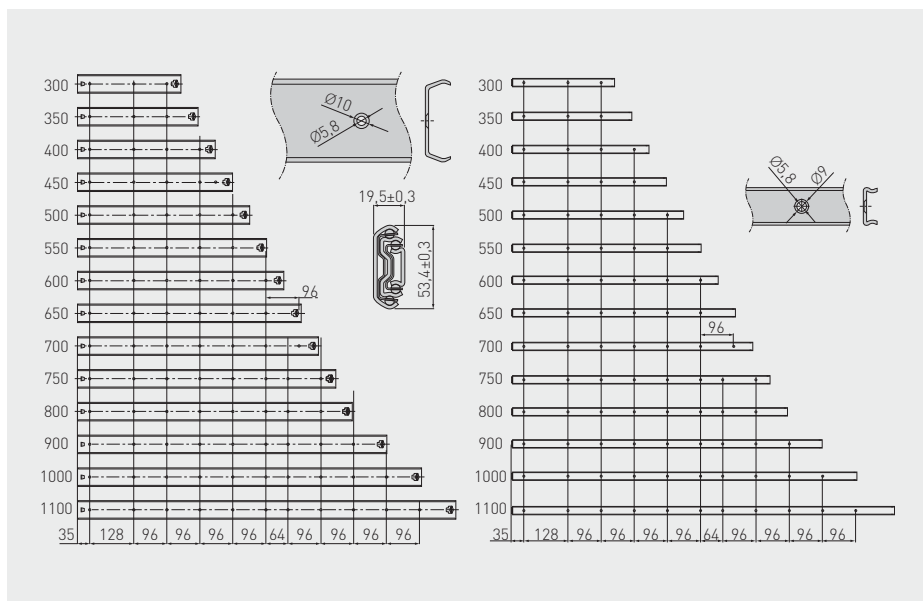







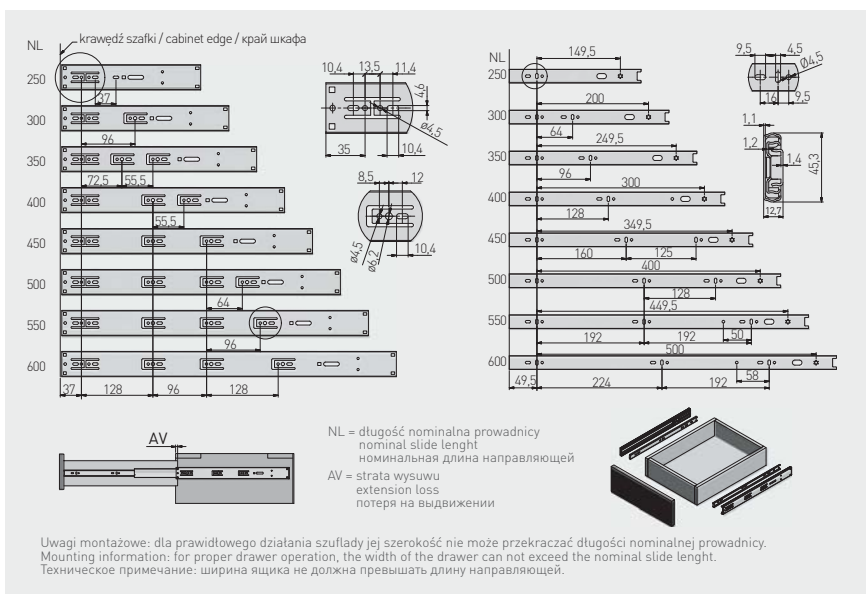

	L mm	AV mm		kg				L mm	AV mm		kg			
PK-0-H53-300	300	-						PK-0-H53-650	650	-				
PK-0-H53-350	350	-						PK-0-H53-700	700	-				
PK-0-H53-400	400	-	petny full	100	ocynk galwanizacja	stal steel		PK-0-H53-750	750	-	petny full	100	ocynk galwanizacja	stal steel
PK-0-H53-450	450	-					96	96	96	96				
PK-0-H53-500	500	-	pełne					PK-0-H53-900	900	-				
PK-0-H53-550	550	-						PK-0-H53-1000	1000	-				
PK-0-H53-600	600	-						PK-0-H53-1100	1100	-				





Prowadnica kulkowa VERSALITE PLUS ze spowalniczem H45
 Ball bearing slide VERSALITE PLUS with soft closing H45
 Шариковая направляющая VERSALITE PLUS с доводчиком H45



		 L mm	 AV mm		 kg		
PK-L-H45-250		250*	102	pełny full полное	30	ocynk galvanized гальваника	stal steel сталь
PK-L-H45-300		300*	52				
PK-L-H45-350		350*	35				
PK-L-H45-400		400*	20				
PK-L-H45-450		450	4				
PK-L-H45-500		500					
PK-L-H45-550		550					
PK-L-H45-600		600					

* Brak pełnego wysuwu / Not full extension / Неполное выдвигение



Prowadnica kulkowa VERSALITE ze spowalniczem H45*
 Ball bearing slide VERSALITE with soft closing H45*
 Шариковая направляющая VERSALITE с доводчиком H45*

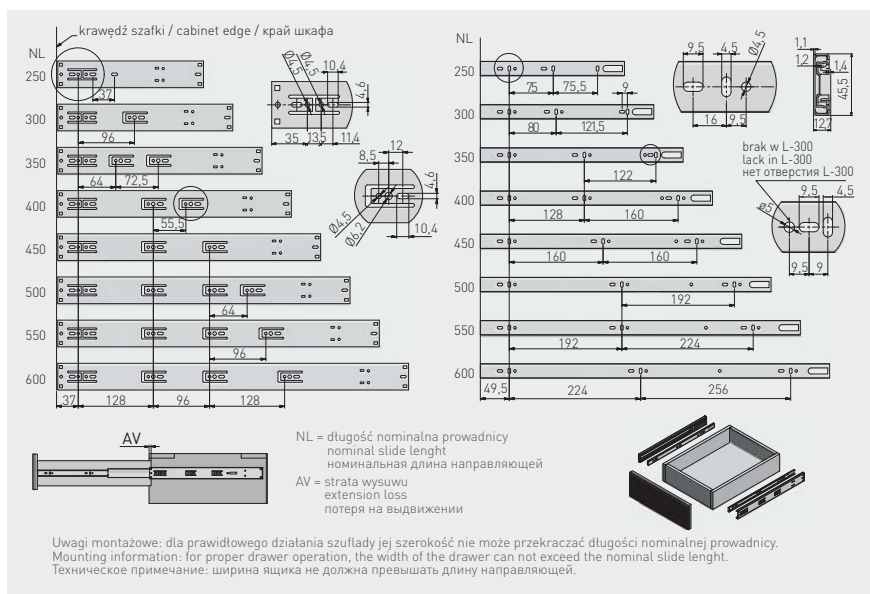

	L mm	AV mm		kg		
PK-L-H45-250-A	250**	55	pełny full полное	30	ocynk galvanized гальваника	stal steel сталь
PK-L-H45-300-A	300	15				
PK-L-H45-350-A	350	5				
PK-L-H45-400-A	400					
PK-L-H45-450-A	450	0				
PK-L-H45-500-A	500					
PK-L-H45-550-A	550					
PK-L-H45-600-A	600					

*Produkt dostępny na indywidualne zamówienie / Available for special orders / Товар доступен под заказ

** Brak pełnego wysuwu / Not full extension / Неполное выдвигание



Prowadnica kulkowa VERSALITE LIGHT ze spowalniczem H45
 Ball bearing slide VERSALITE LIGHT with soft closing H45
 Шариковая направляющая VERSALITE LIGHT с доводчиком H45

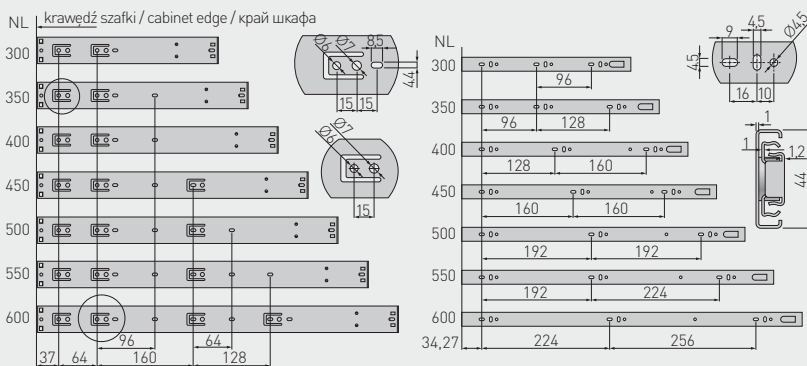

NL = długość nominalna prowadnicy
 nominal slide length
 номинальная длина направляющей
 AV = strata wysuwu
 extension loss
 потеря на выдвигении

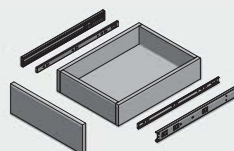

Uwagi montażowe: dla prawidłowego działania szuflady jej szerokość nie może przekraczać długości nominalnej prowadnicy.
 Mounting information: for proper drawer operation, the width of the drawer can not exceed the nominal slide length.
 Техническое примечание: ширина ящика не должна превышать длину направляющей.





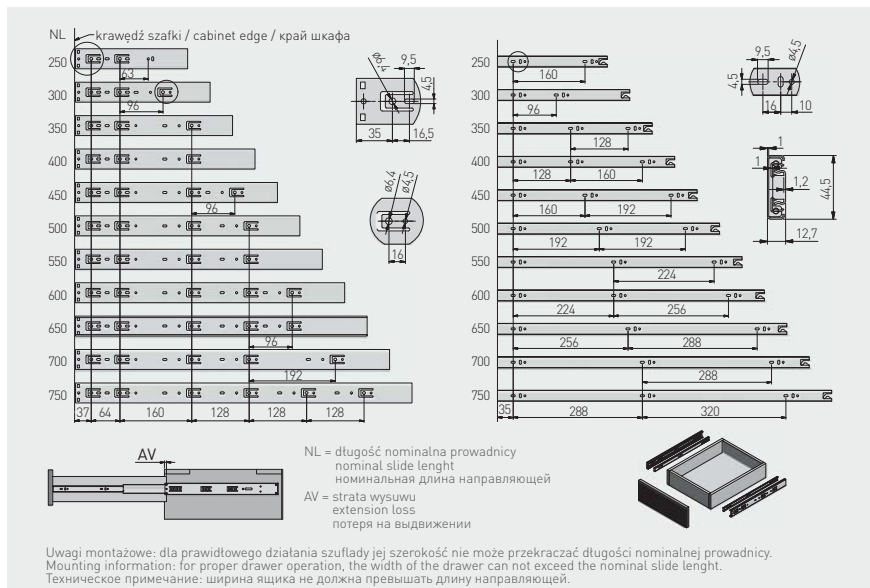

		L mm	AV mm	kg		
PK-L-H45-300-GX		300*	50	25	ocynk galvanized гальваника	stal steel сталь
PK-L-H45-350-GX		350	20			
PK-L-H45-400-GX		400				
PK-L-H45-450-GX		450				
PK-L-H45-500-GX		500				
PK-L-H45-550-GX		550				
PK-L-H45-600-GX		600				

* Brak pełnego wysuwu / Not full extension / Неполное выдвижение



Prowadnica kulkowa z samodociąganiem H45
 Ball bearing slide with self closing H45
 Шариковая направляющая с фиксатором H45



		 L mm	 AV mm	 kg			
PK-S-H45-250		250	22	35	ocynk galvanized гальваника	stal steel сталь	15
PK-S-H45-300		300					
PK-S-H45-350		350					
PK-S-H45-400		400					
PK-S-H45-450		450					
PK-S-H45-500		500					
PK-S-H45-550		550					10
PK-S-H45-600		600					
PK-S-H45-650		650					
PK-S-H45-700		700					











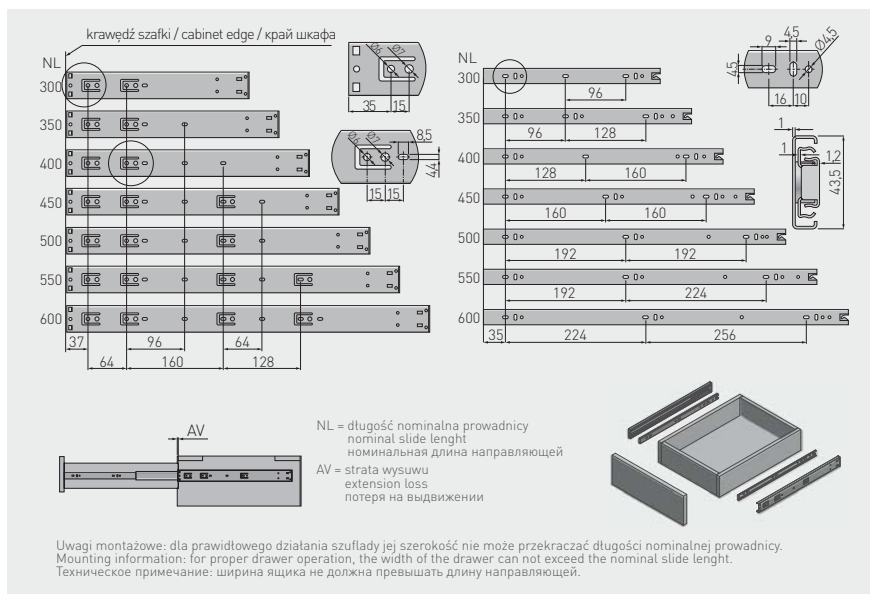

Prowadnica kulkowa push to open H45 GX
 Ball bearing slide push to open H45 GX
 Шариковая направляющая push to open H45 GX



Możliwość zastosowania stabilizatora PB-D-P20STAB
 Can be used with stabilizer PB-D-P20STAB
 Возможность использования стабилизатора PB-D-P20STAB



		 L mm	 AV mm		 kg		
PK-P-H45-300-GX		300*	30	pełny full полное	25	ocynk galvanized гальваника	stal steel сталь
PK-P-H45-350-GX		350					
PK-P-H45-400-GX		400					
PK-P-H45-450-GX		450					
PK-P-H45-500-GX		500					
PK-P-H45-550-GX		550					
PK-P-H45-600-GX		600					

* Brak pełnego wysuwu / Not full extension / Неполное выдвижение



Prowadnica kulkowa H45 PRESTIGE
 Ball bearing slide H45 PRESTIGE
 Шариковая направляющая H45 PRESTIGE

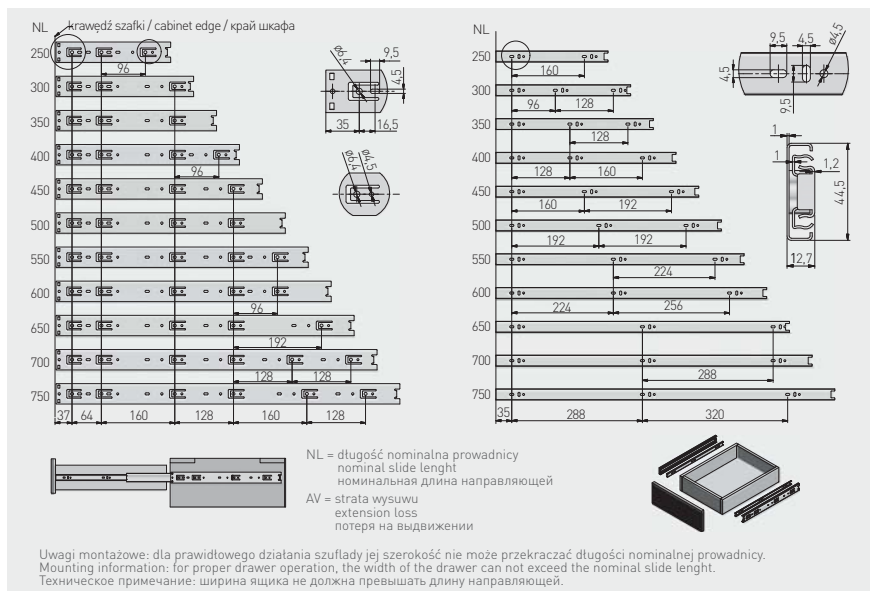

	L mm	AV mm				
PK-0-H45-250	250	-	35	ocynk galvaniz гальваника	stal steel сталь	15
PK-0-H45-300	300					
PK-0-H45-350	350					
PK-0-H45-400	400					
PK-0-H45-450	450					
PK-0-H45-500	500					
PK-0-H45-550	550					
PK-0-H45-600	600	10				
PK-0-H45-700	700					



Prowadnica kulkowa H45 GX1
Ball bearing slide H45 GX1
Шариковая направляющая H45 GX1

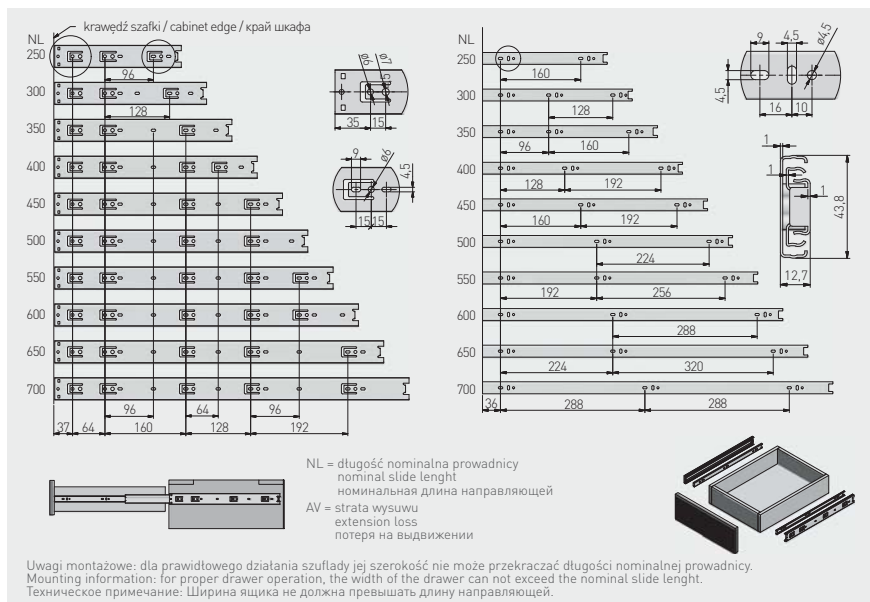

	NL mm	AV mm		kg		
PK-0H45250GX1	250	5	pełny full полное	30	ocynk galwanizowany гальваника	stal steel сталь
PK-0H45300GX1	300					
PK-0H45350GX1	350					
PK-0H45400GX1	400					
PK-0H45450GX1	450					
PK-0H45500GX1	500					
PK-0H45550GX1	550					
PK-0H45600GX1	600					
PK-0H45650GX1	650					
PK-0H45700GX1	700					



Prowadnica kulkowa VERSALITE PLUS ze spowalniczem H35
 Ball bearing slide VERSALITE PLUS with soft closing H35
 Шариковая направляющая VERSALITE PLUS с доводчиком H35

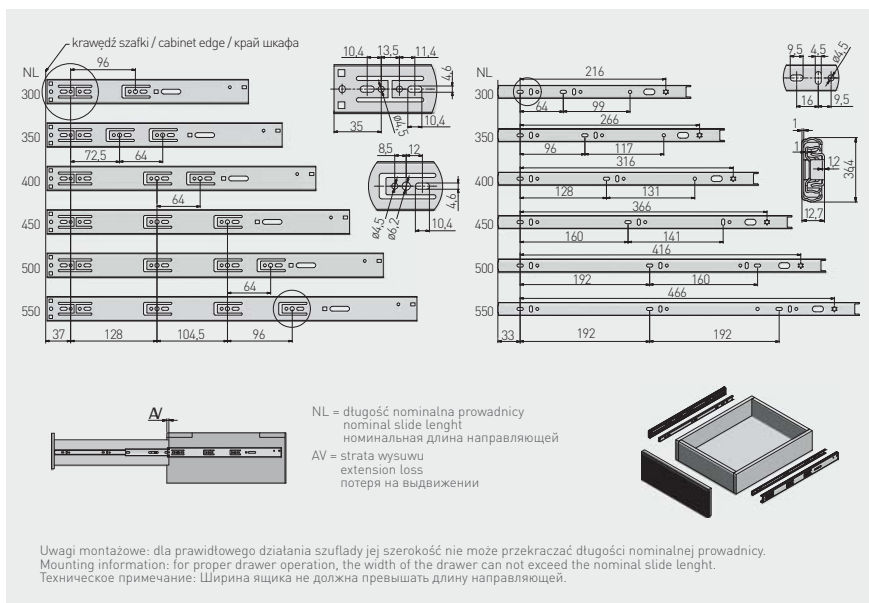

	L mm	AV mm		kg		
PK-L-H35-300	300*	52	pełny full полное	20	ocynk galvanized гальваника	stal steel сталь
PK-L-H35-350	350*	35				
PK-L-H35-400	400	20				
PK-L-H35-450	450	4				
PK-L-H35-500	500					
PK-L-H35-550	550					

* Brak pełnego wysuwu / Not full extension / Неполное выдвигание



Prowadnica kulkowa H35
 Ball bearing slide H35
 Шариковая направляющая H35



NL = długość nominalna prowadnicy
 nominal slide length
 номинальная длина направляющей

AV = strata wysuwu
 extension loss
 потеря на выдвигении

Uwagi montażowe: dla prawidłowego działania szuflady jej szerokość nie może przekraczać długości nominalnej prowadnicy.
 Mounting information: for proper drawer operation, the width of the drawer can not exceed the nominal slide length.
 Техническое примечание: Ширина ящика не должна превышать длину направляющей.

	L mm	AV mm		kg			
PK-0H35-2500	250	4	pełny full полное	20	ocynk galvanized гальваника	stal steel сталь	30
PK-0-H35-3000	300						20
PK-0-H35-3500	350						
PK-0-H35-4000	400						
PK-0-H35-4500	450						
PK-0-H35-5000	500						









Prowadnica kulkowa H30
 Ball bearing slide H30
 Шариковая направляющая H30



NL = długość nominalna prowadnicy
 nominal slide length
 номинальная длина направляющей

AV = strata wysunięciu
 extension loss
 потеря на выдвигании





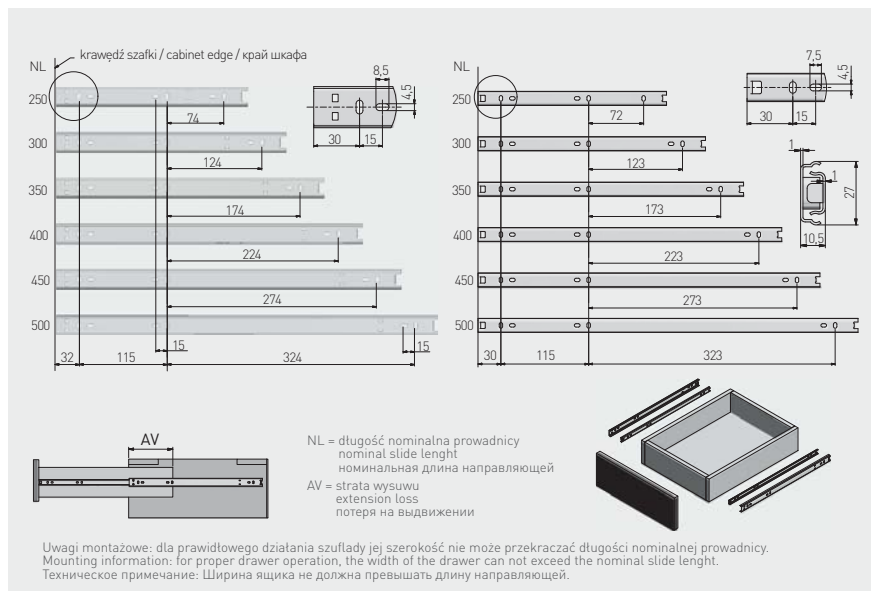

Uwagi montażowe: dla prawidłowego działania szuflady jej szerokość nie może przekraczać długości nominalnej prowadnicy.
 Mounting information: for proper drawer operation, the width of the drawer can not exceed the nominal slide length.
 Техническое примечание: Ширина ящика не должна превышать длину направляющей.

	 L mm	 AV mm		 kg		
PK-0H30-2500	250	-	pełny full полное	15	ocynk galvanized гальваника	stal steel сталь
PK-0H30-3000	300					
PK-0H30-3500	350					
PK-0H30-4000	400					



Prowadnica kulkowa H27
Ball bearing slide H27
Шариковая направляющая H27



		 L mm	 AV mm		 kg		
	PK-0H27-3000	300	109	niepełny partial неполное	15	ocynk galvanized гальваника	stal steel
	PK-0H27-3500	350	124				
	PK-0H27-4000	400	134				
	PK-0H27-4500	450	149				
	PK-0H27-5000	500	184				



Prowadnica kulkowa do półki pod klawiaturę H27
 Ball bearing slide for keyboard H27
 Шариковая направляющая для полки под клавиатуру H27

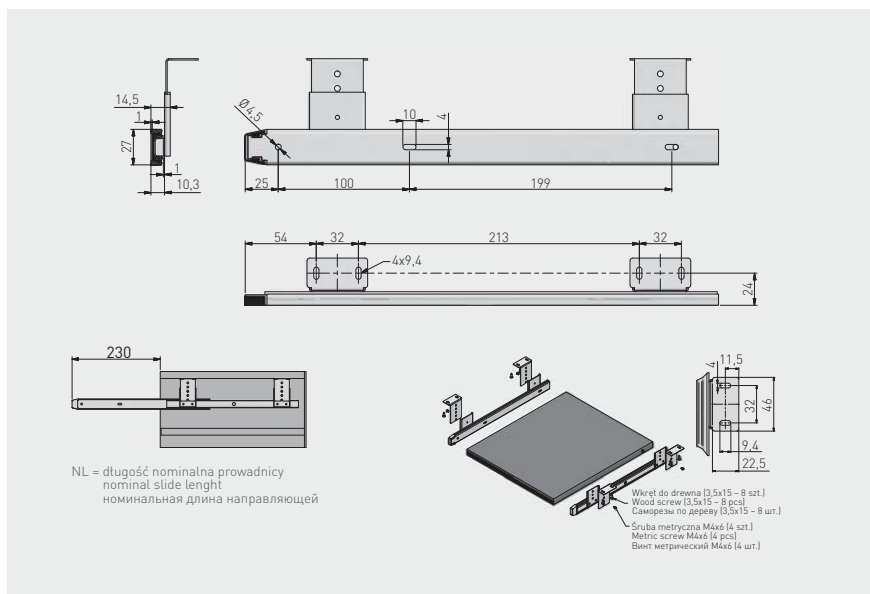

PK-0-000-027	360 mm	niepełny partial неполное	5 kg	os cynk galvanized гальваника	stal steel сталь



Prowadnica kulkowa H17
Ball bearing slide H17
Шариковая направляющая H17

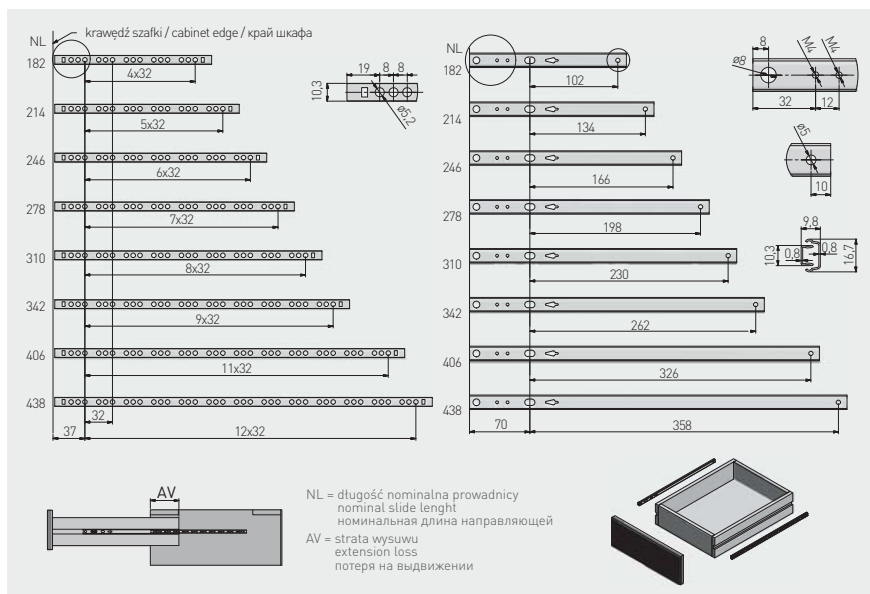

Model	NL (mm)	AV (mm)	Material	Weight (kg)	Finish	Material	Quantity
PK-0H17182XP	182	62	niepełny / partial / неполное	8	ocynk / galvanized / гальваника	stal / steel / сталь	100
PK-0H17214XP	214	77					
PK-0H17246XP	246						
PK-0H17278XP	278						
PK-0H17310XP	310						
PK-0H17342XP	342						
PK-0H17406XP	406						100
PK-0H17438XP	438						



Prowadnica Metalbox MP
Slide Metalbox MP
Направляющая Metalbox MP





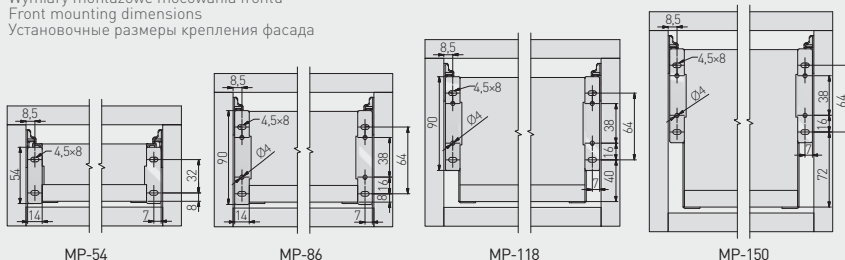



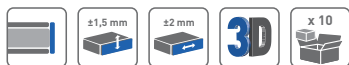
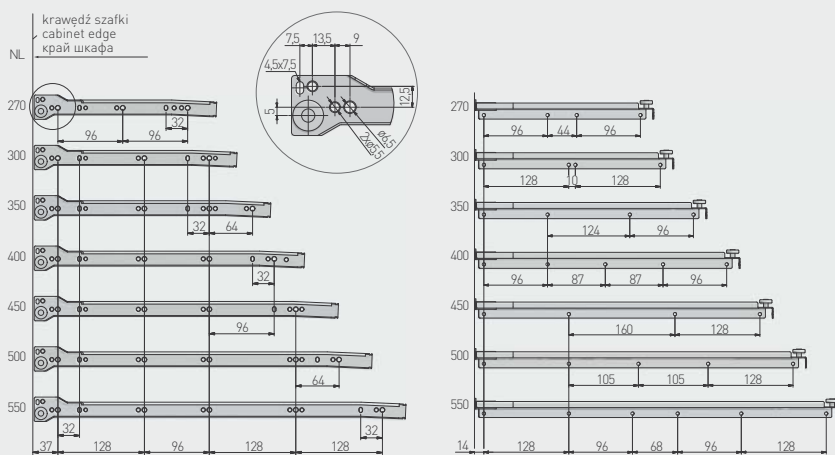

Wymiary montażowe mocowania frontu
Front mounting dimensions
Установочные размеры крепления фасада









Rozstaw otworów montażowych
Mounting dimensions
Монтажные отверстия

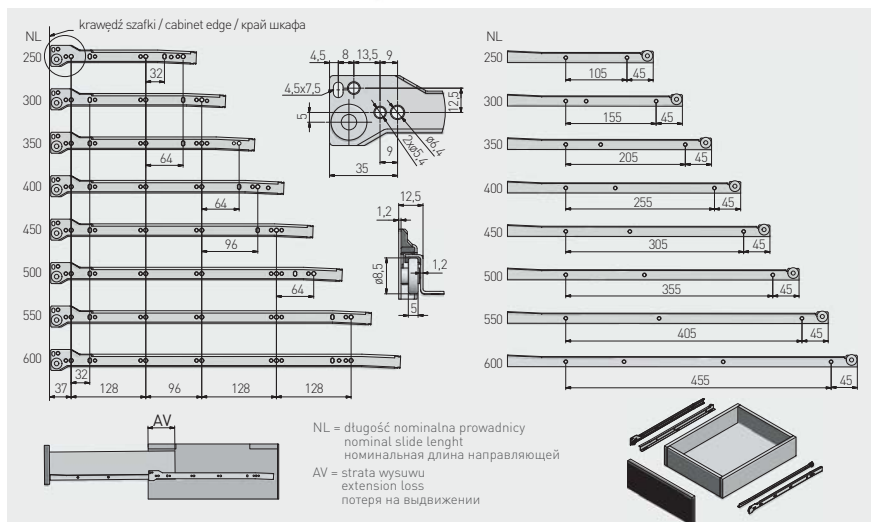

		 H mm	 L mm	 AV mm		 kg			
MP-054350-10	54	350	88	niepełny partial неполное	25	lakier lacquer лак	biały white белый	stal steel сталь	
MP-054400-10		400	98						
MP-054450-10		450							
MP-054500-10		500							
MP-054450-80		450							
MP-054500-80		500							
MP-086350-10	86	350	88	niepełny partial неполное	25	lakier lacquer лак	biały white белый	stal steel сталь	
MP-086450-10		450	98						
MP-086350-80		350	88						
MP-086450-80		450	98						
MP-118350-10	118	350	88	niepełny partial неполное	25	lakier lacquer лак	biały white белый	stal steel сталь	
MP-118400-10		400	98						
MP-118450-10		450							
MP-118500-10		500							
MP-150350-10	150	350	88	niepełny partial неполное	25	lakier lacquer лак	biały white белый	stal steel сталь	
MP-150400-10		400	98						
MP-150450-10		450							
MP-150500-10		500							
MP-150350-80		350	88						
MP-150400-80		400	98						
MP-150450-80		450							
MP-150500-80		500							

Prowadnica rolkowa SP
Euro roller slide
Роликовая направляющая SP



	 L mm	 AV mm	 kg			
PR-SP-250-10	250	85	25	biały white белый	lakier lacquer лак	stal steel сталь
PR-SP-300-10	300					
PR-SP-350-10	350					
PR-SP-400-10	400	95				
PR-SP-450-10	450					
PR-SP-500-10	500					
PR-SP-550-10	550	115				
PR-SP-600-10	600					



Prowadnica rolkowa 0B
Euro roller slide 0B
Роликовая направляющая 0B

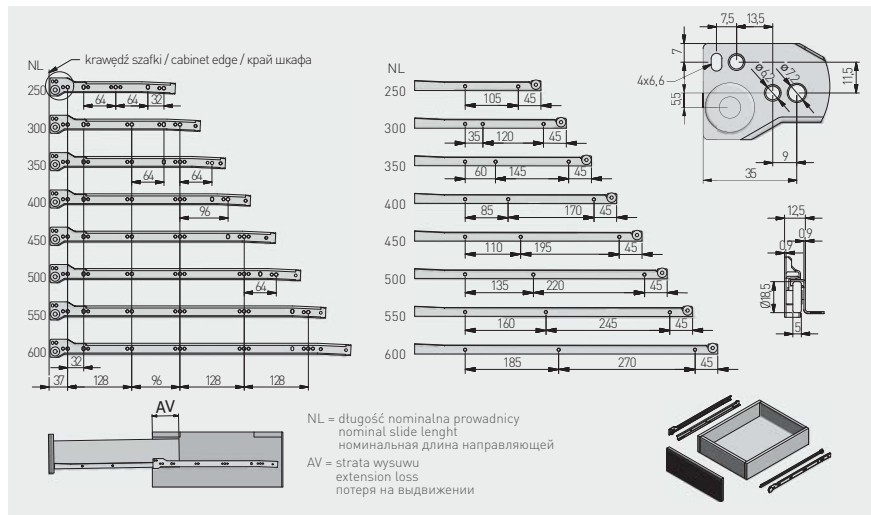



	L mm	AV mm	kg						
PR-0B-250-10	250								
PR-0B-300-10	300								
PR-0B-350-10	350	100							
PR-0B-400-10	400								
PR-0B-450-10	450								
PR-0B-500-10	500	110							
PR-0B-550-10	550	115							
PR-0B-600-10	600	125							
PR-0B-250-30	250								
PR-0B-300-30	300								
PR-0B-350-30	350	100							
PR-0B-400-30	400								
PR-0B-450-30	450								
PR-0B-500-30	500	110							
PR-0B-350-18	350								
PR-0B-400-18	400	100							
PR-0B-450-18	450								
PR-0B-500-18	500	110							
PR-0B-550-18	550	115							
PR-0B-600-18	600	125							

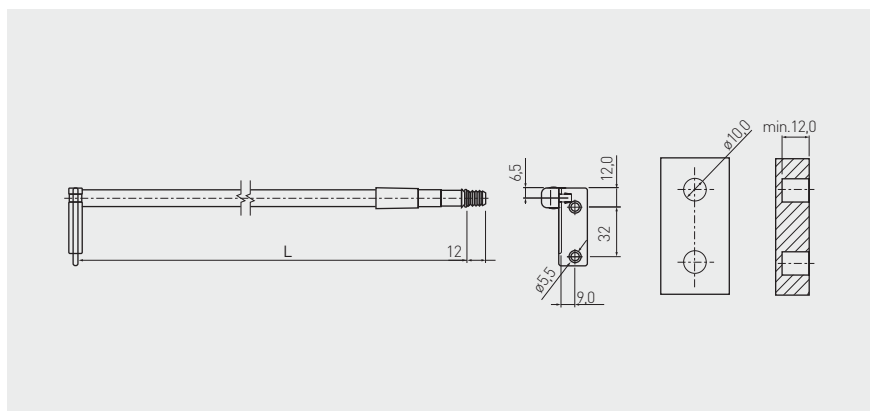

Reling z uchwytem ścianki tylnej lewy / prawy
 Rail with back panel connector left / right
 Релинг с ручкой задней стенки левый / правый



	 L mm	
RS-SZ-400-10	393 / 404	biały / white / белый
RS-SZ-450-10	443 / 454	biały / white / белый
RS-SZ-500-10	493 / 504	biały / white / белый

L – długość rzeczywista relingu mieszcząca się w przedziale (Lmin.; Lmax.) / actual length / фактическая длина релинга в пределах (Lмин; Lмакс)



Spowalniacz do prowadnic rolkowych oraz szuflad typu Metalbox 350 – 550 mm
 Soft closing device for euro roller slide and Metalbox 350 – 550 mm
 Доводчик для роликовых направляющих и Металбоксов 350 – 550 мм



			
AM-MBSOFT-P2	25	szary gray серый	tworzywo plastic пластмасса

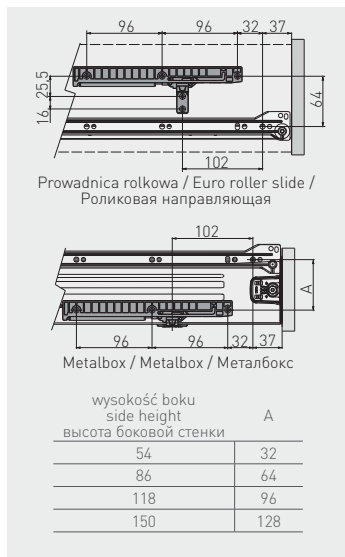

Rolka stabilizująca
 Drawer stabilizer
 Стабилизирующий механизм

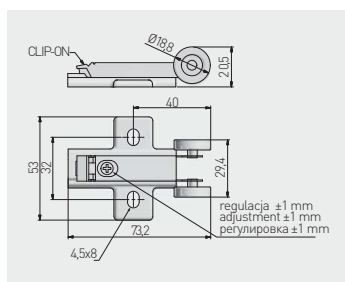

Do szuflad skrzyniowych wyposażonych w prowadnice push to open
 For drawers with push to open
 Для ящиков с направляющими push to open

		
PB-D-P20STAB	nikiel / nickel / никель	stal / steel / сталь



AXIS PRO

Skład zestawu

Set

Комплектация

NEW

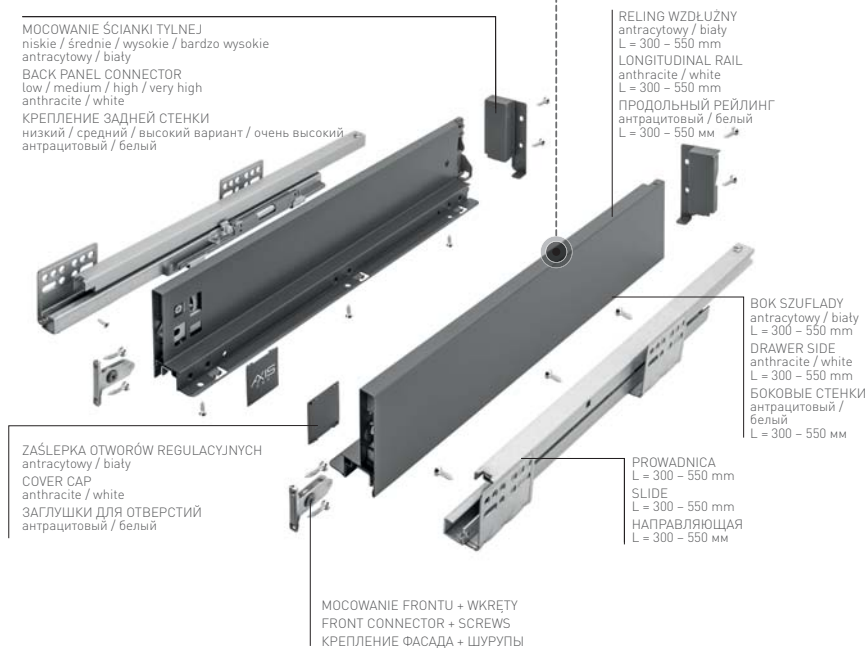

AXIS PRO

Komplet szuflady niskiej A
Low drawer set A
Низкий ящик A

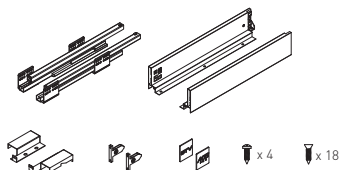

Model	Height (mm)	Color	Finish	Material		
PB-AXISPRO-KPL300A	300	40	antracyt anthracite антрацитовый	lakier lacquer лак		
PB-AXISPRO-KPL350A	350					
PB-AXISPRO-KPL400A	400					
PB-AXISPRO-KPL450A	450					
PB-AXISPRO-KPL500A	500					
PB-AXISPRO-KPL550A	550					
PB-AXISPRO-KPL300A1	300				biały white белый	lakier lacquer лак
PB-AXISPRO-KPL350A1	350					
PB-AXISPRO-KPL400A1	400					
PB-AXISPRO-KPL450A1	450					
PB-AXISPRO-KPL500A1	500					
PB-AXISPRO-KPL550A1	550					

AXIS PRO

Komplet szuflady średniej B
Medium drawer set B
Средний ящик B

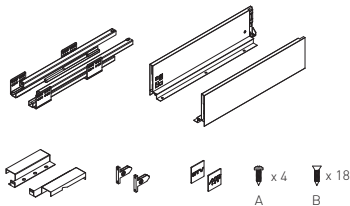

Model	Height (mm)	Color	Finish	Material		
PB-AXISPRO-KPL300B	300	40	antracyt anthracite антрацитовый	lakier lacquer лак		
PB-AXISPRO-KPL350B	350					
PB-AXISPRO-KPL400B	400					
PB-AXISPRO-KPL450B	450					
PB-AXISPRO-KPL500B	500					
PB-AXISPRO-KPL550B	550					
PB-AXISPRO-KPL300B1	300				biały white белый	lakier lacquer лак
PB-AXISPRO-KPL350B1	350					
PB-AXISPRO-KPL400B1	400					
PB-AXISPRO-KPL450B1	450					
PB-AXISPRO-KPL500B1	500					
PB-AXISPRO-KPL550B1	550					

AXIS PRO

Komplet szuflady wysokiej C
High drawer set C
Высокий ящик C

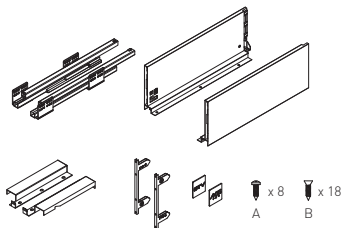

PB-AXISPRO-KPL300C	300	40	antracyt anthracite антрацитовый	lakier lacquer лак	stal steel сталь
PB-AXISPRO-KPL350C	350				
PB-AXISPRO-KPL400C	400				
PB-AXISPRO-KPL450C	450				
PB-AXISPRO-KPL500C	500				
PB-AXISPRO-KPL550C	550		biały white белый		
PB-AXISPRO-KPL300C1	300				
PB-AXISPRO-KPL350C1	350				
PB-AXISPRO-KPL400C1	400				
PB-AXISPRO-KPL450C1	450				
PB-AXISPRO-KPL500C1	500				
PB-AXISPRO-KPL550C1	550				

AXIS PRO

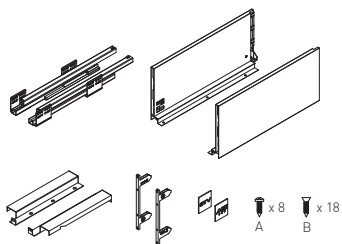

Komplet szuflady bardzo wysokiej D
Very high drawer set D
Очень высокий ящик D

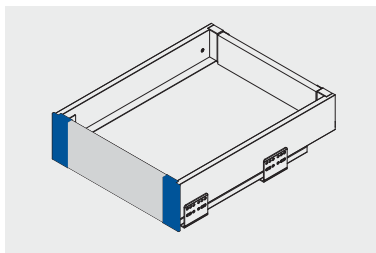

PB-AXISPRO-KPL300D	300	40	antracyt anthracite антрацитовый	lakier lacquer лак	stal steel сталь
PB-AXISPRO-KPL350D	350				
PB-AXISPRO-KPL400D	400				
PB-AXISPRO-KPL450D	450				
PB-AXISPRO-KPL500D	500				
PB-AXISPRO-KPL550D	550		biały white белый		
PB-AXISPRO-KPL300D1	300				
PB-AXISPRO-KPL350D1	350				
PB-AXISPRO-KPL400D1	400				
PB-AXISPRO-KPL450D1	450				
PB-AXISPRO-KPL500D1	500				
PB-AXISPRO-KPL550D1	550				

Złączka frontu wewnętrznego niska
 Inner front connector low
 Соединитель передней панели, низкий



			
PB-AXISPRO-WEWM0CA		antracyt anthracite антрацитовый	stal steel сталь
PB-AXISPRO-WEWM0CA1		biały white белый	

Złączka frontu wewnętrznego średnia
 Inner front connector medium
 Соединитель передней панели, передней

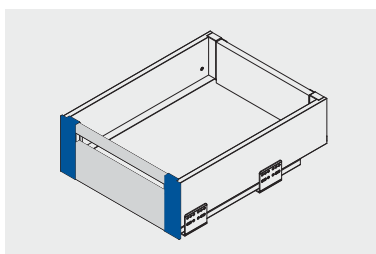

			
PB-AXISPRO-WEWM0CB		antracyt anthracite антрацитовый	stal steel сталь
PB-AXISPRO-WEWM0CB1		biały white белый	

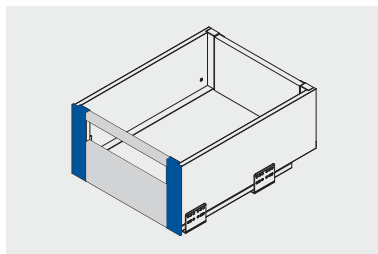

Złączka frontu wewnętrznego wysoka
 Inner front connector high
 Соединитель передней панели, высокий



			
PB-AXISPRO-WEWM0CC		antracyt anthracite антрацитовый	stal steel сталь
PB-AXISPRO-WEWM0CC1		biały white белый	

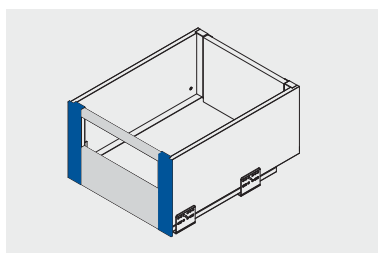



Złączka frontu wewnętrznego bardzo wysoka
 Inner front connector very high
 Соединитель передней панели, очень высокий

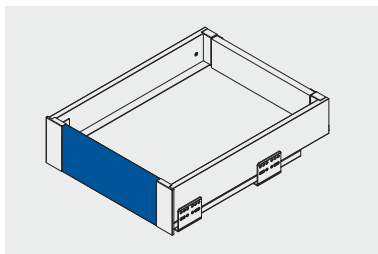

			
PB-AXISPRO-WEWM0CD		antracyt anthracite антрацитовый	stal steel сталь
PB-AXISPRO-WEWM0CD1		biały white белый	





Panel przedni do szuflady wewnętrznej niskiej
 Front panel for low inside drawer
 Передняя панель для низкого внутреннего ящика

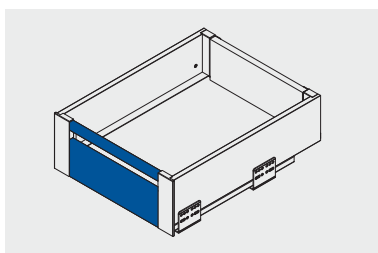

	 H mm	 L mm		
PB-AXISPRO-PANELWEW-110-10	110	1200	antracyt anthracite антрацитовый	stal steel сталь
PB-AXISPRO-PANELWEW-110			biały white белый	





Panel przedni + reling do szuflady wewnętrznej średniej
 Front panel + railing for medium internal drawer
 Передняя панель + перила для среднего внутреннего ящика

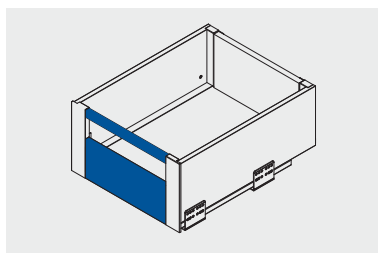

	 H mm	 L mm		
PB-AXISPRO-PANELWEW-95R	95	1200	antracyt anthracite антрацитовый	stal steel сталь
PB-AXISPRO-PANELWEW-95R-10			biały white белый	





Panel przedni + reling do szuflady wewnętrznej wysokiej
 Front panel + railing for the high internal drawer
 Передняя панель + перила для высокого внутреннего ящика

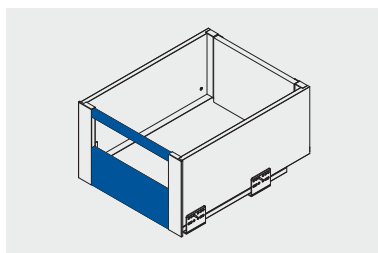

		 H mm	 L mm		
PB-AXISPRO-PANELWEW-110R		110	1200	antracyt anthracite антрацитовый	stal steel сталь
PB-AXISPRO-PANELWEW-110R-10				biały white белый	

Panel przedni + reling do szuflady wewnętrznej bardzo wysokiej
 Front panel + railing for the very high internal drawer
 Передняя панель + перила для очень высокого внутреннего ящика



		 H mm	 L mm		
PB-AXISPRO-PANELWEW-110R		110	1200	antracyt anthracite антрацитовый	stal steel сталь
PB-AXISPRO-PANELWEW-110R-10				biały white белый	

Reling wzdużny kwadratowy
 Square longitudinal railing
 Квадратные продольные перила

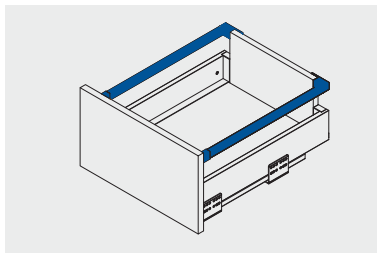

PB-AXISPRO-RELKW300	300	antracyt anthracite антрацитовый	stal steel сталь
PB-AXISPRO-RELKW350	350		
PB-AXISPRO-RELKW400	400		
PB-AXISPRO-RELKW450	450		
PB-AXISPRO-RELKW500	500		
PB-AXISPRO-RELKW550	550	biały white белый	
PB-AXISPRO-RELKW300-10	300		
PB-AXISPRO-RELKW350-10	350		
PB-AXISPRO-RELKW400-10	400		
PB-AXISPRO-RELKW450-10	450		
PB-AXISPRO-RELKW500-10	500		
PB-AXISPRO-RELKW550-10	550		



Modern Box Square

Skład zestawu

Set

Комплектация

MOCOWANIE ŚCIANKI TYLNEJ

niskie / średnie / wysokie
szary / biały

BACK PANEL CONNECTOR

low / medium / high
gray / white

КРЕПЛЕНИЕ ЗАДНЕЙ СТЕНКИ

низкий / средний / высокий вариант
серый / белый

RELING WZDŁUŻNY

szary / biały

L = 250 - 550 mm

LONGITUDINAL RAIL

gray / white

L = 250 - 550 mm

ПРОДОЛЬНЫЙ РЕЙЛИНГ

серый / белый

L = 250 - 550 mm

BOK SZUFLADY

szary / biały

L = 250 - 550 mm

DRAWER SIDE

gray / white

L = 250 - 550 mm

БОКОВЫЕ СТЕНКИ

серый / белый

L = 250 - 550 mm

MOCOWANIE FRONTU + WKRETY

FRONT CONNECTOR + SCREWS

КРЕПЛЕНИЕ ФАСАДА + ШУРУПЫ

ZASŁEPKA OTWORÓW REGULACYJNYCH

szara / biały

COVER CAP

gray / white

ЗАГЛУШКИ ДЛЯ ОТВЕРСТИЙ

серый / белый

PROWADNICA

L = 250 - 550 mm

SLIDE

L = 250 - 550 mm

НАПРАВЛЯЮЩАЯ

L = 250 - 550 mm



Modern Box Square

Komplet szuflady niskiej A
Low drawer set A
Низкий ящик A

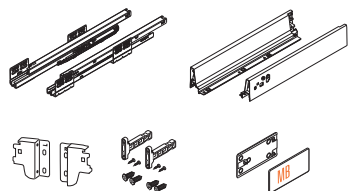

PB-KW-KPL300A	300	40		szary gray серый	lakier lacquer лак	stal steel сталь
PB-KW-KPL350A	350					
PB-KW-KPL400A	400					
PB-KW-KPL450A	450					
PB-KW-KPL500A	500					
PB-KW-KPL550A	550					
PB-KW-KPL250A1	250					
PB-KW-KPL300A1	300					
PB-KW-KPL350A1	350					
PB-KW-KPL400A1	400					
PB-KW-KPL450A1	450					
PB-KW-KPL500A1	500					
PB-KW-KPL550A1	550					
PB-KW-KPL250A2	250					
PB-KW-KPL300A2	300					
PB-KW-KPL350A2	350					
PB-KW-KPL400A2	400					
PB-KW-KPL450A2	450					
PB-KW-KPL500A2	500					
PB-KW-KPL550A2	550					
				antracyt anthracite антрацитовый		

Modern Box Square

Komplet szuflady średniej B
Medium drawer set B
Средний ящик B

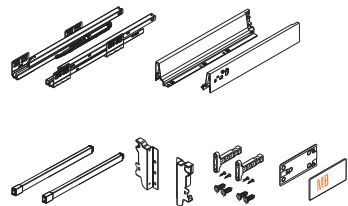

PB-KW-KPL250B	250	40		szary gray серый	lakier lacquer лак	stal steel сталь
PB-KW-KPL350B	350					
PB-KW-KPL400B	400					
PB-KW-KPL450B	450					
PB-KW-KPL500B	500					
PB-KW-KPL550B	550					
PB-KW-KPL250B1	250					
PB-KW-KPL300B1	300					
PB-KW-KPL350B1	350					
PB-KW-KPL400B1	400					
PB-KW-KPL450B1	450					
PB-KW-KPL500B1	500					
PB-KW-KPL550B1	550					
PB-KW-KPL250B2	250					
PB-KW-KPL300B2	300					
PB-KW-KPL350B2	350					
PB-KW-KPL400B2	400					
PB-KW-KPL450B2	450					
PB-KW-KPL500B2	500					
PB-KW-KPL550B2	550					
				antracyt anthracite антрацитовый		

Modern Box Square

Komplet szuflady wysokiej C
High drawer set C
Высокий ящик C

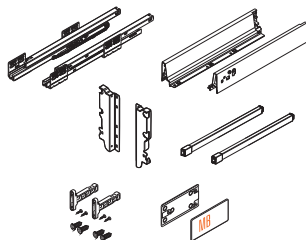

	L mm	kg			
PB-KW-KPL250C	250		szary gray серый	40	lakier lacquer лак
PB-KW-KPL300C	300				
PB-KW-KPL350C	350				
PB-KW-KPL400C	400				
PB-KW-KPL450C	450				
PB-KW-KPL500C	500		biały white белый		
PB-KW-KPL250C1	250				
PB-KW-KPL300C1	300				
PB-KW-KPL350C1	350				
PB-KW-KPL400C1	400				
PB-KW-KPL450C1	450		antracyt anthracite антрацитовый		
PB-KW-KPL500C1	500				
PB-KW-KPL250C2	250				
PB-KW-KPL300C2	300				
PB-KW-KPL350C2	350				
PB-KW-KPL400C2	400				
PB-KW-KPL450C2	450				
PB-KW-KPL500C2	500				
PB-KW-KPL550C2	550				

Reiling wzdużny Longitudinal drawer rail Продольный рейлинг

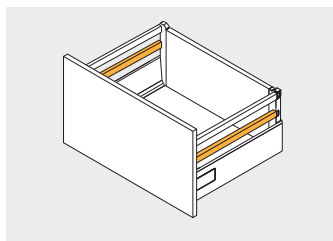

	L mm			
PB-D-RELKW350	350	szary gray серый	lakier lacquer лак	stal steel сталь
PB-D-RELKW400	400			
PB-D-RELKW450	450			
PB-D-RELKW500	500			
PB-D-RELKW550	550			

	L mm			
PB-D-RELKW350-10	350	biały white белый	lakier lacquer лак	stal steel сталь
PB-D-RELKW400-10	400			
PB-D-RELKW450-10	450			
PB-D-RELKW500-10	500			
PB-D-RELKW550-10	550			



Złączka frontu wewnętrznego, niska
 Inner front connector, low
 Соединитель передней панели, низкий

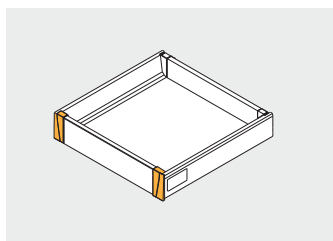

PB-D-WEWMOCA-KW	szuflada niska A low drawer A низкий ящик A	szary / gray / серый	tworzywo plastic пластмасса
PB-D-WEWMOCA-KW-10		biały / white / белый	



Złączka frontu wewnętrznego, średnia
 Inner front connector, medium
 Соединитель передней панели, средний

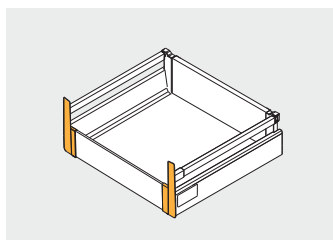

PB-D-WEWMOCB-KW	szuflada średnia B medium drawer B средний ящик B	szary / gray / серый	tworzywo plastic пластмасса
PB-D-WEWMOCB-KW-10		biały / white / белый	



Złączka frontu wewnętrznego, wysoka
 Inner front connector, high
 Соединитель передней панели, высокий

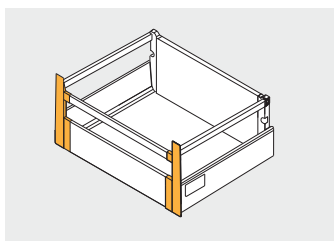

PB-D-WEWMOCC-KW	szuflada wysoka C high drawer C высокий ящик C	szary / gray / серый	tworzywo plastic пластмасса
PB-D-WEWMOCC-KW-10		biały / white / белый	



Panel przedni frontu wewnętrznego
 Front panel
 Передняя панель внутреннего ящика

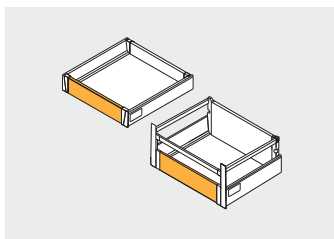
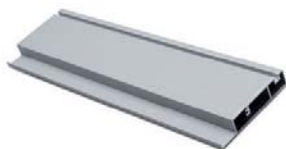

PB-D-PANELWEW	1100	szary / gray / серый	aluminium aluminium алюминий
PB-D-PANELWEW-10		biały / white / белый	



Reling poprzeczny
Transverse rail
Поперечный рейлинг

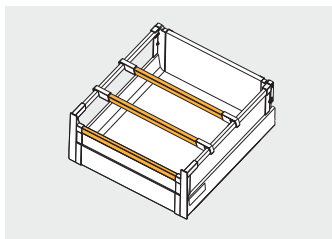

			
PB-RP-KW1100	1100	szary / gray / серый	stal steel сталь
PB-RP-KW1100-10		biały / white / белый	



Łącznik relingu poprzecznego
Transverse rail connector
Соединитель поперечного рейлинга

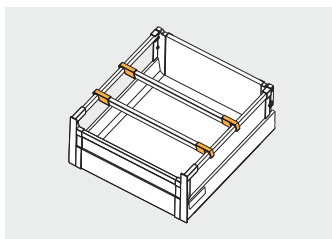

			
PB-D-ZR-KW-00	1 kpl. = 2 szt. 1 set = 2 pcs 1 комп. = 2 шт.	szary / gray / серый	tworzywo plastic пластмасса
PB-D-ZR-KW-10		biały / white / белый	



Listwa poprzeczna
Transverse bar
Поперечная планка

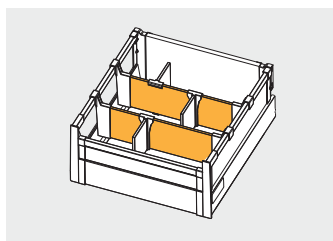





			
PB-D-LIS1100-KW	1100	szary / gray / серый	aluminium aluminium алюминий
PB-D-LIS1100-KW-10		biały / white / белый	

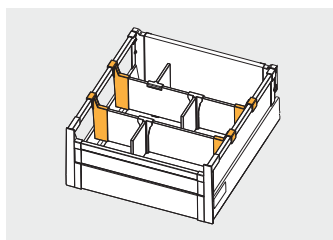

Złączka do listwy poprzecznej
Transverse bar connector
Соединитель поперечной планки



			
PB-D-CONREL-KW	1 kpl. = 2 szt. 1 set = 2 pcs 1 комп. = 2 шт.	szary / gray / серый	tworzywo plastic пластмасса
PB-D-CONREL-KW-10		biały / white / белый	



Przegroda do listwy poprzecznej
 Transverse bar divider
 Перегородка для поперечной планки

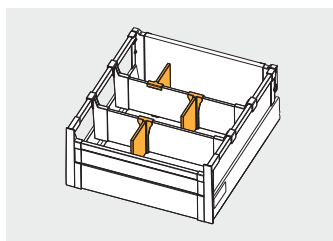

PB-D-PRZEGLP-KW	1 szt. 1 pc 1 шт.	szary / gray / серый	tworzywo plastic пластмасса
PB-D-PRZEGLP-KW-10		biały / white / белый	



Bok perforowany
 Perforated side
 Перфорированная сторона

NEW

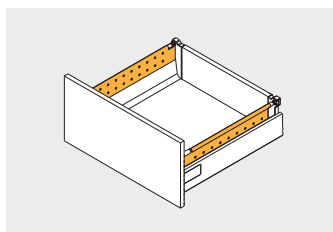

PB-D-BXSIDEKW50C	500	szary gray серый	stal steel сталь
PB-D-BXSIDEKW45C	450		
PB-D-BXSIDEKW45C-10	450	biały white белый	
PB-D-BXSIDEKW50C-10	500		
PB-D-BXSIDEKW50C-60	500	antracyt anthracite антрацитовый	
PB-D-BXSIDEKW45C-60	450		



Mocowanie relingu do podwyższonej ścianki tylnej
 Back panel connector for rails, additional
 Соединитель задней стенки для рейлингов, дополнительная

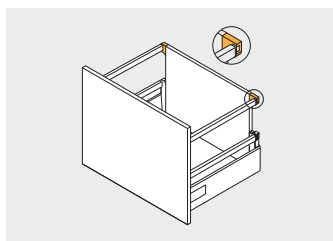

			
PB-D-D2R0-00	1 kpl. = 2 szt. 1 set = 2 pcs	szary / gray / серый	tworzywo plastic пластмасса
PB-D-D2R0-01	1 комп. = 2 шт.	biały / white / белый	



Złączka ścianki tylnej, niska
 Back panel connector, low
 Держатель задней стенки, низкий

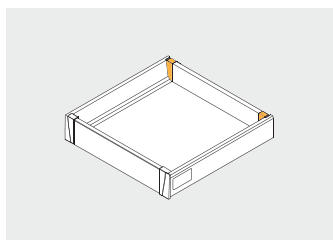

			
PB-D-N2R0-00	1 kpl. = L+P 1 set = L+R	szary / gray / серый	stal steel сталь
PB-D-N2R0-01	1 комп. = Л+П	biały / white / белый	



Złączka ścianki tylnej, średnia
 Back panel connector, medium
 Держатель задней стенки, средний

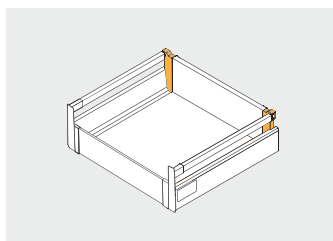

PB-D-S2R0-00	1 kpl. = L+P 1 set = L+R	szary / gray / серый	stal steel сталь
PB-D-S2R0-01	1 комп. = Л+П	biały / white / белый	



Złączka ścianki tylnej, wysoka
 Back panel connector, high
 Держатель задней стенки, высокий

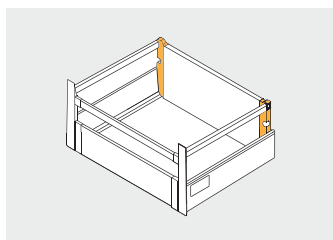

PB-D-W2R0-00	1 kpl. = L+P 1 set = L+R	szary / gray / серый	stal steel сталь
PB-D-W2R0-01	1 комп. = Л+П	biały / white / белый	



Mocowanie do relingów
 Rails mounting
 Держатель рейлинга



			
PB-D-MHG04-KW	1 szt. 1 pc 1 шт.	szary gray серый	tworzywo plastic пластмасса



Matryca do relingów
 Marking gauge for rails
 Матрица для рейлингов



			
PB-D-MATRYCA	1 kpl. = 1 szt. 1 set = 1 pc 1 комп. = 1 шт.	szary gray серый	tworzywo plastic пластмасса



Znacznik do frontów
 Marking gauge for drawer front
 Маркер фасада



PB-D-ZNACZ-0



1 kpl. = 2 szt.
 1 set = 2 pcs
 1 комп. = 2 шт.



szary
 gray
 серый



ZnAl



Modern Box



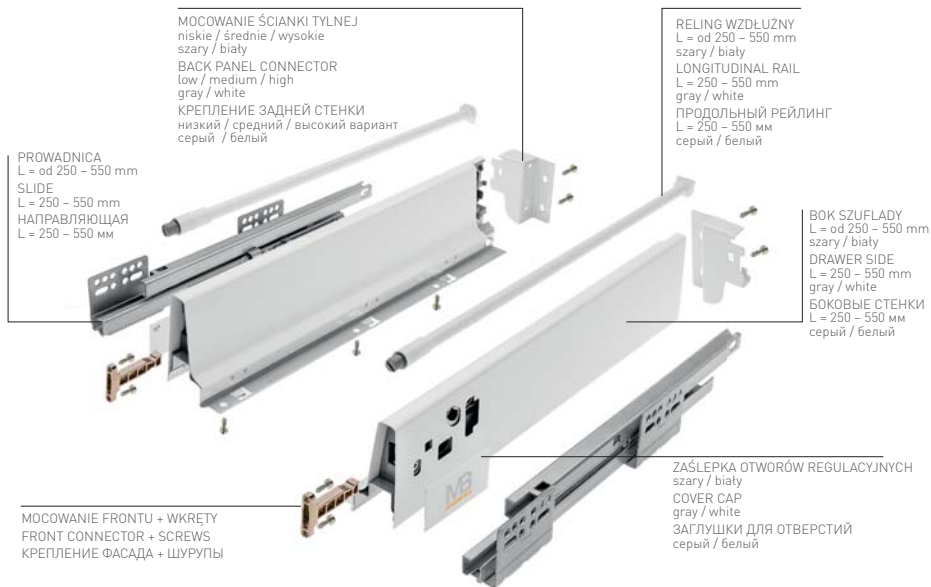



Skład zestawu
Set
Комплектация

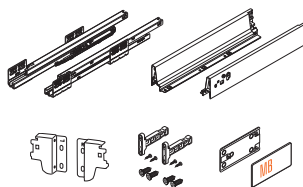

Modern Box

Komplet szuflady niskiej A
Low drawer set A
Низкий ящик А



		 L mm		 kg				
PB-D-KPL250A		250	soft close	40	szary gray серый	lakier lacquer лак	stal steel сталь	
PB-D-KPL300A		300						
PB-D-KPL350A		350						
PB-D-KPL400A		400						
PB-D-KPL450A		450						
PB-D-KPL500A		500						
PB-D-KPL550A		550						
PB-D-KPL250A1		250			push to open			szary gray серый
PB-D-KPL300A1		300						
PB-D-KPL350A1		350						
PB-D-KPL400A1		400						
PB-D-KPL450A1		450						
PB-D-KPL500A1		500						
PB-D-KPL550A1		550						
PB-D-P20250A		250			push to open			szary gray серый
PB-D-P20300A		300						
PB-D-P20350A		350						
PB-D-P20400A		400						
PB-D-P20450A		450						
PB-D-P20500A		500						



Modern Box

Komplet szuflady średniej B
Medium drawer set B
Средний ящик B



PB-D-KPL300B	300	soft close	40	szary gray серый	lakier lacquer лак	stal steel сталь
PB-D-KPL350B	350					
PB-D-KPL400B	400					
PB-D-KPL450B	450					
PB-D-KPL500B	500					
PB-D-KPL550B	550					

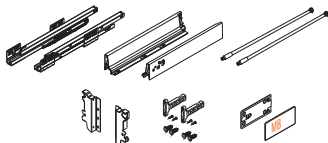

Modern Box

Komplet szuflady wysokiej C
High drawer set C
Высокий ящик C









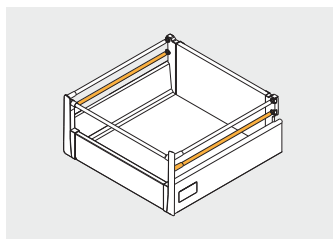





PB-D-KPL250C	250	soft close	40	szary gray серый	lakier lacquer лак	stal steel сталь				
PB-D-KPL300C	300									
PB-D-KPL350C	350									
PB-D-KPL400C	400									
PB-D-KPL450C	450									
PB-D-KPL500C	500									
PB-D-KPL550C	550									
PB-D-KPL250C1	250			push to open			40	biały white белый	lakier lacquer лак	stal steel сталь
PB-D-KPL300C1	300									
PB-D-KPL350C1	350									
PB-D-KPL400C1	400									
PB-D-KPL450C1	450									
PB-D-KPL500C1	500									
PB-D-KPL550C1	550									
PB-D-P20300C	300									
PB-D-P20350C	350									
PB-D-P20400C	400									
PB-D-P20450C	450									
PB-D-P20500C	500									
PB-D-P20550C	550									



Reлинг wzdużny
Longitudinal rail
Продольный рейлинг







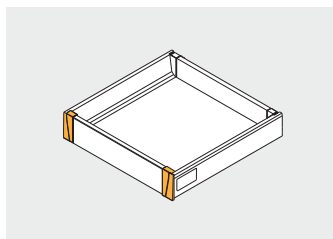

	 L mm		
PB-D-REL2500	250		
PB-D-REL3000	300		
PB-D-REL3500	350		
PB-D-REL4000	400		
PB-D-REL4500	450		
PB-D-REL5000	500		
PB-D-REL5500	550	szary gray серый	stal steel сталь

	 L mm		
PB-D-REL450-10	450		
PB-D-REL500-10	500		
PB-D-REL550-10	550		
		biały white белый	stal steel сталь



Złączka frontu wewnętrznego, niska
Inner front connector, low
Соединитель передней панели, низкий



			
PB-D-WEWMOCA	szuflada niska A low drawer A низкий ящик A		
PB-D-WEWMOCA1			
		biały / white / белый	



Złączka frontu wewnętrznego, średnia
 Inner drawer connector, medium
 Соединитель передней панели, средний

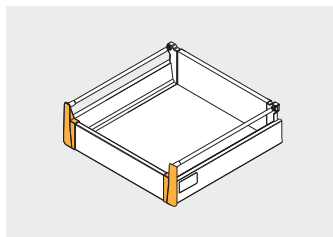

PB-D-WEWMOCB	szuflada średnia B medium drawer B средний ящик B	szary / gray / серый	tworzywo plastic пластмасса
PB-D-WEWMOCB1		biały / white / белый	



Złączka frontu wewnętrznego, wysoka, do 1 kompletu relingów
 Inner drawer connector high, for 1 set of rails
 Соединитель передней панели, высокий, для 1 комплекта рейлингов

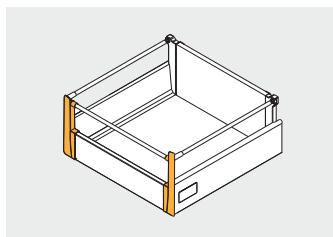





PB-D-WEWSZKLC	szuflada wysoka C, 1 reling high drawer C, 1 rail высокий ящик C, рейлинг - 1 шт.	szary / gray / серый	tworzywo plastic пластмасса
PB-D-WEWSZKLC-10		biały / white / белый	

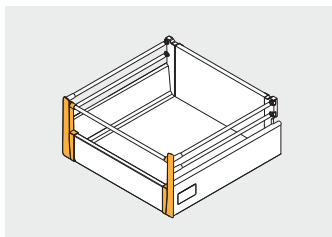

Złączka frontu wewnętrzno, wysoka, do 2 kompletów relingów
 Inner drawer front connector, high, for 2 sets of rails
 Соединитель передней панели, высокий, для 2 комплектов релингов







			
PB-D-WEWMOCC	szuflada wysoka C, 2 relingi high drawer C, 2 rails	szary / gray / серый	tworzywo plastic пластмасса
PB-D-WEWMOCC1	wysoki jacyk C, reling -2 szt.	biały / white / белый	

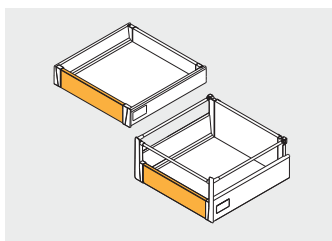

Panel przedni frontu wewnętrzno
 Front panel
 Передняя панель







			
PB-D-PANELWEW	1100	szary / gray / серый	aluminium aluminium алюминий
PB-D-PANELWEW-10		biały / white / белый	

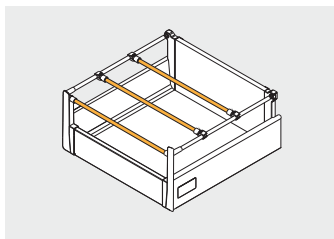

Reling poprzeczny
Transverse rail
Поперечный рейлинг



	 mm		
PB-D-RP-1100	1100	szary / gray / серый	stal steel сталь
PB-D-RP-1100-10		biały / white / белый	



Łącznik relingu poprzecznego
Transverse rail connector
Соединитель поперечного рейлинга

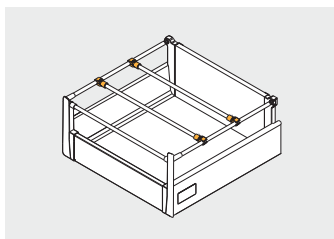

			
PB-D-ZR-00-0	1 kpl. = 2 szt. 1 set = 2 pcs 1 комп. = 2 шт.	szary / gray / серый	tworzywo plastic пластмасса
PB-D-ZR-00-10		biały / white / белый	



Uchwyt do szuflady wewnętrznej
 Inner drawer handle
 Ручка для внутреннего ящика

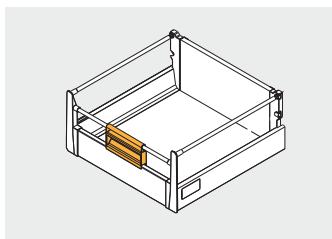

PB-D-UCHWEW	szary / gray / серый	tworzywo plastic пластмасса
PB-D-UCHWEW-10	biały / white / белый	



Łącznik krzyżowy do relingu
 Cross rail connector
 Крестообразный соединитель рейлингов

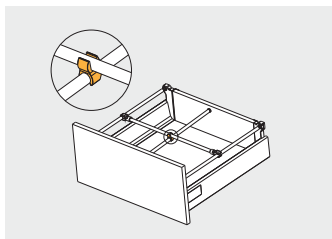

PB-D-LR-00-0	szary / gray / серый	tworzywo plastic пластмасса
PB-D-LR-00-10	biały / white / белый	



Zaślepka do relingu poprzecznego
End cap for transverse rail
Заглушка для поперечного рейлинга

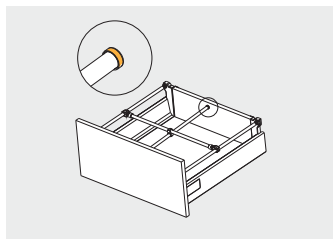

PB-D-RELCOV	szary / gray / серый	tworzywo plastic пластмасса
PB-D-RELCOV-10	biały / white / белый	



Listwa poprzeczna
Transverse bar
Поперечная планка

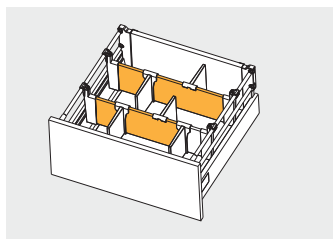

PB-D-LIS1100	1100	szary / gray / серый	aluminium aluminium алюминий
PB-D-LIS1100-10		biały / white / белый	



Złączka listwy poprzecznej do relingu
 Connector for transverse rail and bar
 Соединитель поперечных планок и рейлингов

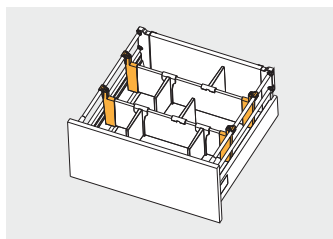

PB-D-CONREL	1 kpl. = 2 szt. 1 set = 2 pcs 1 комп. = 2 шт.	szary / gray / серый	tworzywo plastic пластмасса
PB-D-CONREL-10		biały / white / белый	



Złączka listwy poprzecznej do boku perforowanego
 Transverse bar connector for perforated sides
 Соединитель поперечных планок и перфорированных боковин

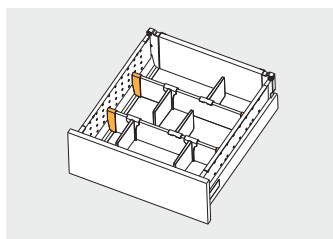

PB-D-CONBXSID	1 kpl. = 2 szt. 1 set = 2 pcs 1 комп. = 2 шт.	szary / gray / серый	tworzywo plastic пластмасса
PB-D-CONBXSIDE-10		biały / white / белый	



Przegroda listwy poprzecznej
 Transverse bar divider
 Перегородка для поперечной планки

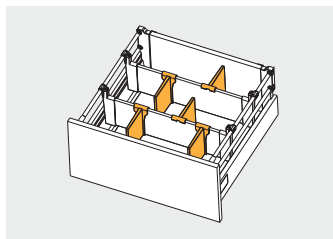

PB-D-PRZEGLP	szary / gray / серый	tworzywo plastic пластмасса
PB-D-PRZEGLP-10	biały / white / белый	



Wok perforowany do szuflady średniej
 Perforated side for medium drawer
 Перфорированная боковина, низкая

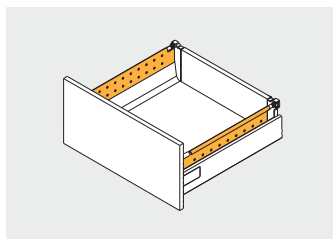





PB-D-BXSIDE45B	450	szary / gray / серый	stal steel сталь
PB-D-BXSIDE45B-10		biały / white / белый	
PB-D-BXSIDE50B	500	szary / gray / серый	
PB-D-BXSIDE50B-10		biały / white / белый	

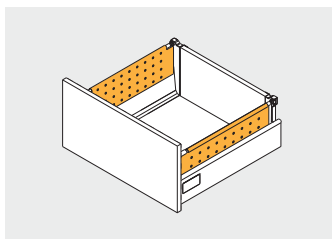
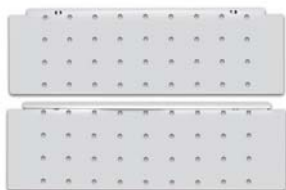

Bok perforowany do szuflady wysokiej
Perforated side for high drawer
Перфорированная боковина, высокая







	 L mm		
PB-D-BXSIDE45C	450	szary / gray / серый	stal steel сталь
PB-D-BXSIDE45C-10		biały / white / белый	
PB-D-BXSIDE50C	500	szary / gray / серый	
PB-D-BXSIDE50C-10		biały / white / белый	

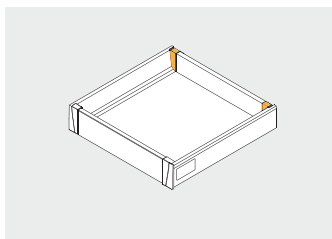

Złączka ścianki tylnej, niska
Back panel connector, low
Соединитель задней стенки, низкий







			
PB-D-N2R0-00	1 kpl. = L+P 1 set = L+R	szary / gray / серый	stal steel сталь
PB-D-N2R0-01	1 комп. = Л+П	biały / white / белый	

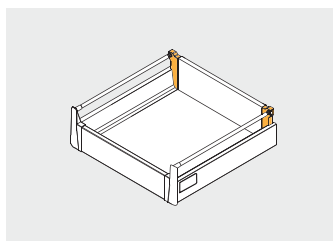

Złączka ścianki tylnej, średnia
 Back panel connector, medium
 Соединитель задней стенки, средний







			
PB-D-S2R0-00	1 kpl. = L+P 1 set = L+R	szary / gray / серый	stal steel
PB-D-S2R0-01	1 комп. = Л+П	biały / white / белый	сталь

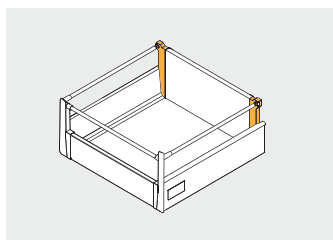

Złączka ścianki tylnej, wysoka
 Back panel connector, high
 Соединитель задней стенки, высокий



			
PB-D-W2R0-00	1 kpl. = L+P 1 set = L+R	szary / gray / серый	stal steel
PB-D-W2R0-01	1 комп. = Л+П	biały / white / белый	сталь



Mocowanie relingu do podwyższonej ścianki tylnej
 Back panel connector for rails, additional
 Соединитель задней стенки для рейлингов, дополнительная

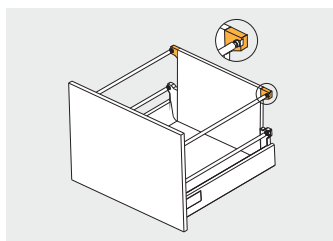





			
PB-D-D2R0-00	1 kpl. = 2 szt. 1 set = 2 pcs	szary / gray / серый	tworzywo plastic пластмасса
PB-D-D2R0-01	1 комп. = 2 шт.	biały / white / белый	



Matryca do relingów
 Marking gauge for rails
 Матрица для рейлингов







			
PB-D-MATRYCA	1 kpl. = 1 szt. 1 set = 1 pcs 1 комп. = 1 шт.	szary gray серый	tworzywo plastic пластмасса



Znacznik do frontów
 Marking gauge for drawer front
 Маркер фасада







			
PB-D-ZNACZ-0	1 kpl. = 2 szt. 1 set = 2 pcs 1 комп. = 2 шт.	szary gray серый	ZnAl



Mocowanie do relingów
 Rail mounting
 Держатель рейлинга







			
PB-D-MHG04	1 kpl. = 2 szt. 1 set = 2 pcs 1 комп. = 2 шт.	szary gray серый	tworzywo plastic пластмасса

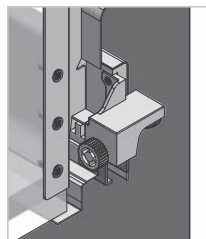

Rolka stabilizująca do szuflad push to open
 Drawer stabilizer for push to open drawers
 Стабилизирующий механизм для ящиков









			
PB-D-MBSTAB-00	1 kpl. = L+P 1 set = L+R 1 комп. = Л+П	szary gray серый	tworzywo plastic пластмасса



Modern Box

Komplet szuflady piekarnikowej niskiej
 Under oven drawer set, low
 Ящик под духовку, низкий



					
PB-D-KPL68-450-80	450	40	szary gray серый	lakier lacquer лак	stal steel сталь
PB-D-KPL68-500-80	500				
PB-D-KPL68-450-10	450		biały white белый		
PB-D-KPL68-500-10	500				

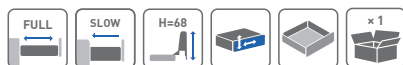
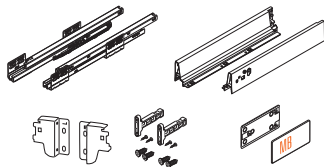

Modern Box

Komplet szuflady zlewozmywakowej niskiej
Under sink drawer – set
Ящик под мойку

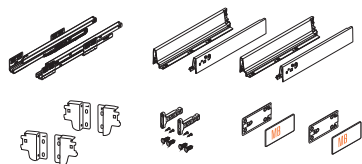

PB-D-ZLE-450	450	40	szary gray серый	lakier lacquer лак	stal steel сталь
PB-D-ZLE-500	500				

Modern Box

Komplet szuflady zlewozmywakowej U, niskiej
Under sink drawer U, low – set
Ящик под мойку U, низкий – компоненты

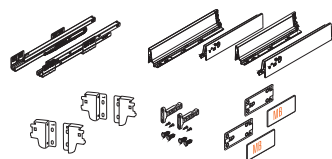

PB-D-ULE-500	500	40	szary gray серый	lakier lacquer лак	stal steel сталь
--------------	-----	----	------------------------	--------------------------	------------------------



MB
MODERN BOX

Podpórka PELIKAN mini Shelf support PELIKAN mini Полкодержатель PELIKAN мини

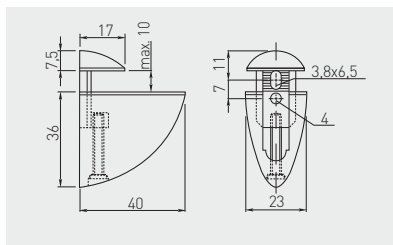

PP-XS0045-01	chrom / chrome / хром	ZnAl
PP-XS0045-05	aluminium / aluminium / алюминий	

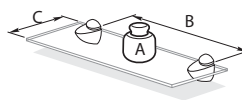

A - max. 5 kg / макс. 5 кг
B - 25 cm / 25 см
C - 15 cm / 15 см

Maksymalne obciążenie zależy od ilości wsporników i materiału, z jakiego wykonana jest półka.

The maximum load depends on the number of supports and material of which the shelf is made.

Максимальная нагрузка зависит от количества кронштейнов и материала, из которого изготовлена полка.

Podpórka PELIKAN mata Shelf support PELIKAN small Полкодержатель PELIKAN маленький

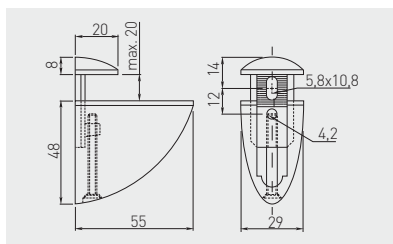

PP-MP0055-01	chrom / chrome / хром	ZnAl
PP-MP0055-02	satyna / satin / сатин	
PP-MP0055-05	aluminium / aluminium / алюминий	
PP-MP0055-06	stal szcztokowana / brushed steel / шлифованная сталь	
PP-MP0055-10	biały / white / белый	
PP-MP0055-20	czarny / black / чёрный	

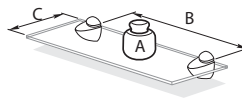

A - max. 8 kg / макс. 8 кг
B - 40 cm / 40 см
C - 20 cm / 20 см

Maksymalne obciążenie zależy od ilości wsporników i materiału, z jakiego wykonana jest półka.

The maximum load depends on the number of supports and material of which the shelf is made.

Максимальная нагрузка зависит от количества кронштейнов и материала, из которого изготовлена полка.

Podpórka PELIKAN średnia Shelf support PELIKAN medium Полкодержатель PELIKAN средний

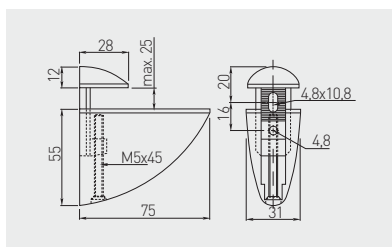

PP-SP0075-01	chrom / chrome / хром	ZnAl	
PP-SP0075-02	satyna / satin / сатин		
PP-SP0075-05	aluminium / aluminium / алюминий		
PP-SP0075-06	stal szczotkowana / brushed steel / шлифованная сталь		

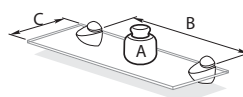

A - max. 10 kg / макс. 10 кг
B - 50 cm / 50 см
C - 25 cm / 25 см

Maksymalne obciążenie zależy od ilości wsporników i materiału, z jakiego wykonana jest półka.

The maximum load depends on the number of supports and material of which the self is made.

Максимальная нагрузка зависит от количества кронштейнов и материала, из которого изготовлена полка.

Podpórka PELIKAN duża Shelf support PELIKAN large Полкодержатель PELIKAN большой

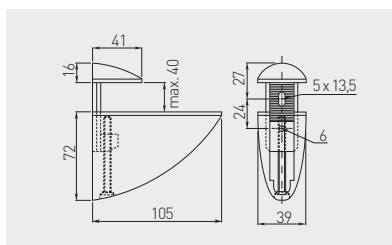

PP-DP0105-01	chrom / chrome / хром	ZnAl	
PP-DP0105-02	satyna / satin / сатин		
PP-DP0105-05	aluminium / aluminium / алюминий		
PP-DP0105-06	stal szczotkowana / brushed steel / шлифованная сталь		

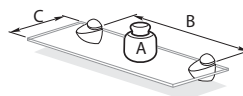

A - max. 12 kg / макс. 12 кг
B - 60 cm / 60 см
C - 30 cm / 30 см

Maksymalne obciążenie zależy od ilości wsporników i materiału, z jakiego wykonana jest półka.

The maximum load depends on the number of supports and material of which the self is made.

Максимальная нагрузка зависит от количества кронштейнов и материала, из которого изготовлена полка.

Podpórka GS01 Shelf support GS01 Полкодержатель GS01

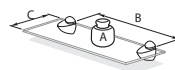
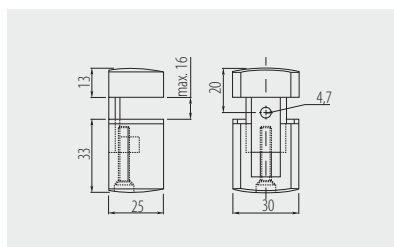

A - max. 3 kg / макс. 3 кг
B - 25 cm / см
C - 15 cm / см

Maksymalne obciążenie zależy od ilości wsporników i materiału, z jakiego wykonana jest półka.

The maximum load depends on the number of supports and material of which the shelf is made.

Максимальная нагрузка зависит от количества кронштейнов и материала, из которого изготовлена полка.

PP-00GS01-01	chrom / chrome / хром	ZnAl
PP-00GS01-02	satyna / satin / сатин	



Podpórka GS02 Shelf support GS02 Полкодержатель GS02

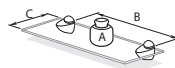
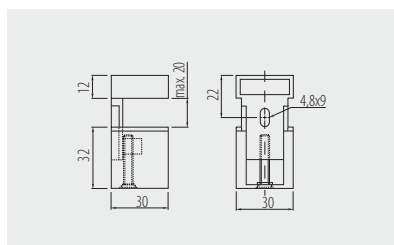

A - max. 4 kg / макс. 4 кг
B - 40 cm / см
C - 20 cm / см

Maksymalne obciążenie zależy od ilości wsporników i materiału, z jakiego wykonana jest półka.

The maximum load depends on the number of supports and material of which the shelf is made.

Максимальная нагрузка зависит от количества кронштейнов и материала, из которого изготовлена полка.

PP-00GS02-01	chrom / chrome / хром	ZnAl
PP-00GS02-02	satyna / satin / сатин	
PP-00GS02-05	aluminium / aluminium / алюминий	
PP-00GS02-06	stal szorstkowana / brushed steel / шлифованная сталь	



Podpórka GS03 Shelf support GS03 Полкодержатель GS03

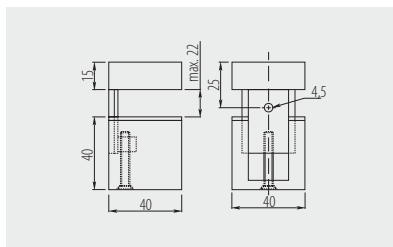

PP-00GS03-01	chrom / chrome / хром	ZnAl
PP-00GS03-02	satyna / satin / сатин	
PP-00GS03-05	aluminium / aluminium / алюминий	
PP-00GS03-06	stal szcztokowana / brushed steel / шлифованная сталь	

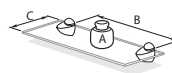

A - max. 6 kg / макс. 6 кг
B - 50 cm / см
C - 25 cm / см

Maksymalne obciążenie zależy od ilości wsporników i materiału, z jakiego wykonana jest półka.

The maximum load depends on the number of supports and material of which the self is made.

Максимальная нагрузка зависит от количества кронштейнов и материала, из которого изготовлена полка.

Podpórka GS04 Shelf support GS04 Полкодержатель GS04

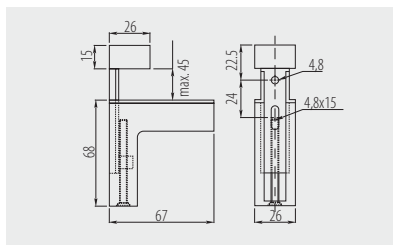

PP-00GS04-01	chrom / chrome / хром	ZnAl
PP-00GS04-02	satyna / satin / сатин	
PP-00GS04-05	aluminium / aluminium / алюминий	
PP-00GS04-06	stal szcztokowana / brushed steel / шлифованная сталь	

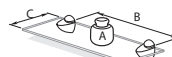

A - max. 10 kg / макс. 10 кг
B - 60 cm / см
C - 30 cm / см

Maksymalne obciążenie zależy od ilości wsporników i materiału, z jakiego wykonana jest półka.

The maximum load depends on the number of supports and material of which the self is made.

Максимальная нагрузка зависит от количества кронштейнов и материала, из которого изготовлена полка.

Podpórka A48 mocowana na wkręt
Shelf support A48 screw mounted
Полкодержатель A48 монтаж на винт

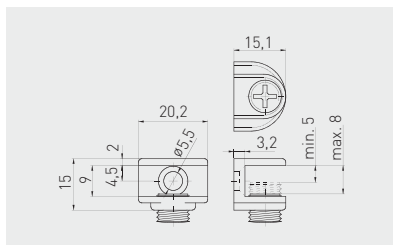

PP-GL-A48-01

chrom / chrome / хром

ZnAl



Podpórka B48 mocowana na wcisk
Shelf support B48 plug in
Полкодержатель B48 вставной

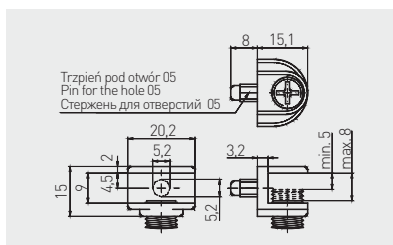

PP-GL-B48-01

chrom / chrome / хром

ZnAl



Podpórka CGP mocowana na wkręt
Shelf support CGP screw mounted
Полкодержатель CGP монтаж на винт

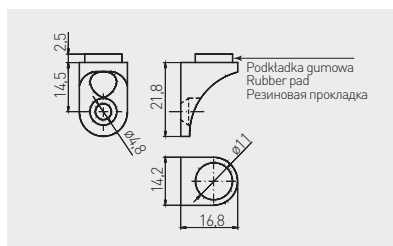

PP-GL-CGP-01



chrom / chrome / хром



ZnAl



Podpórka E410 mocowana na wcisk
Shelf support E410 plug in
Полкодержатель E410 вставной

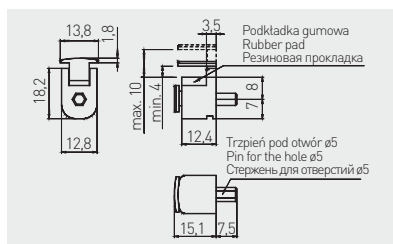

PP-GL-E410-01



chrom / chrome / хром



ZnAl





Podpórka SL3
Shelf support SL3
Полкодержатель SL3

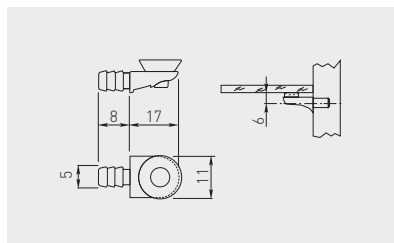

PP-S0L003-01T



chrom / chrome / хром



ZnAl, tworzywo / ZnAl, plastic / ZnAl, пластмасса



Podpórka SL12
Shelf support SL12
Полкодержатель SL12

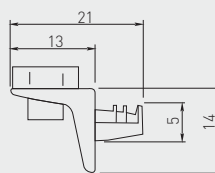

Grubość szkła max. 5 mm
Glass thickness max. 5 mm
Толщина стекла макс. 5 мм



PP-S0L012-01T



chrom / chrome / хром



ZnAl, tworzywo / ZnAl, plastic / ZnAl, пластмасса



Podpórka HS0
Shelf support HS0
Полкодержатель HS0

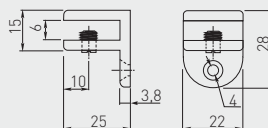

Grubość szkła max. 5 mm
Glass thickness max. 5 mm
Толщина стекла макс. 5 мм



PP-HS0006-01



chrom / chrome / хром



ZnAl



Podpórka HS2
Shelf support HS2
Полкодержатель HS2

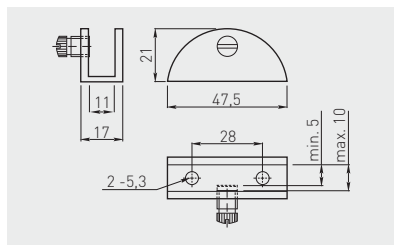

PP-HS2710-01



chrom / chrome / хром



ZnAl



GLASS



x 300

Podpórka J63
Shelf support J63
Полкодержатель J63

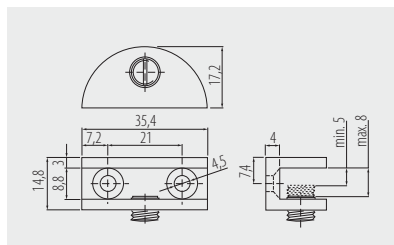

MC-J63-01



chrom / chrome / хром



ZnAl

MC-J63-05

stal szcztokowana / brushed steel / шлифованная сталь









GLASS

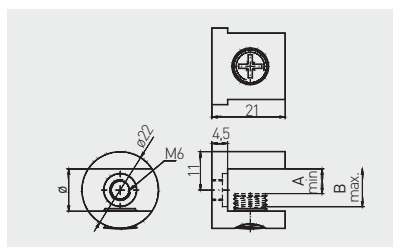

x 100

Podpórka J65
Shelf support J65
Полкодержатель J65



		 mm	 mm	 mm		
MC-J65-08-01		8	4	8	chrom / chrome / хром	ZnAl
MC-J65-08-05		8	4	8	stal szorstkowana / brushed steel / шлифованная сталь	
MC-J65-10-01		10	6	10	chrom / chrome / хром	
MC-J65-10-05		10	6	10	stal szorstkowana / brushed steel / шлифованная сталь	
MC-J65-12-01		12	7	11	chrom / chrome / хром	
MC-J65-12-05		12	7	11	stal szorstkowana / brushed steel / шлифованная сталь	



Podpórka J123
Shelf support J123
Полкодержатель J123

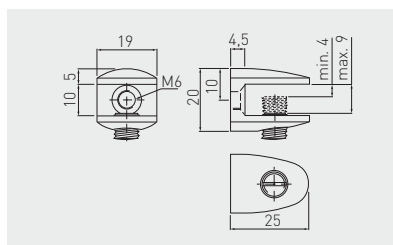

			
MC-J123-01		chrom / chrome / хром	ZnAl
MC-J123-05		stal szorstkowana / brushed steel / шлифованная сталь	



Podpórka K135
Shelf support K135
Полкодержатель K135

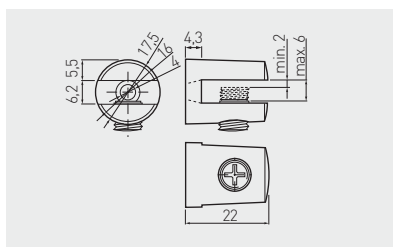

MC-K135-06-01



chrom / chrome / хром



ZnAl



Mocowanie J01
Fixture J01
Крепление J01

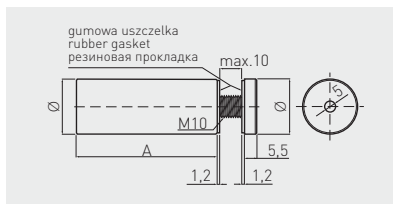

MC-J01A-12-01



mm



mm

chrom / chrome / хром



MC-J01A-12-06

12

16,5

stal szcztokowana / brushed steel / шлифованная сталь

160

MC-J01A-16-01

16

25

chrom / chrome / хром

stal szcztokowana / brushed steel / шлифованная сталь

stal
steel
сталь

60

MC-J01A-19-01

19

35

chrom / chrome / хром

stal szcztokowana / brushed steel / шлифованная сталь

40

MC-J01A-25-01

25

64

chrom / chrome / хром





stal szcztokowana / brushed steel / шлифованная сталь

10

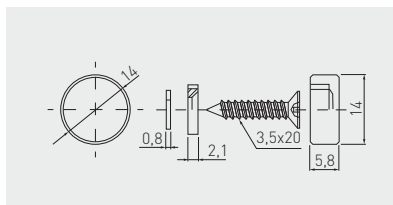

Mocowanie J04
Fixture J04
Крепление J04



		 mm			
MC-J04A2-14-01		14	chrom / chrome / хром	ZnAl	300
MC-J04A2-14-05		14	stal szcztokowana / brushed steel / шлифованная сталь		
MC-J04A2-18-01		18	chrom / chrome / хром		200
MC-J04A2-22-01		22	chrom / chrome / хром		100



Mocowanie J60
Fixture J60
Крепление J60

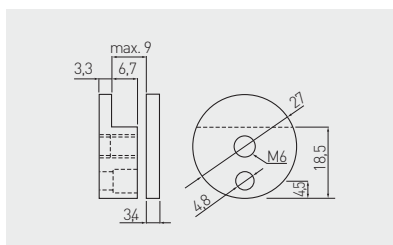

			
MC-J60A27-01		chrom / chrome / хром	ZnAl
MC-J60A27-05		stal szcztokowana / brushed steel / шлифованная сталь	



Mocowanie J62
 Fixture J62
 Крепление J62

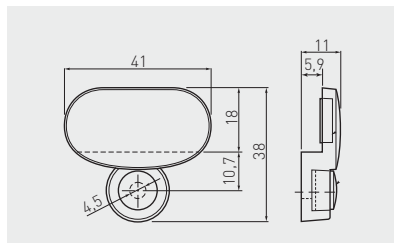

		
MC-J62-01	chrom / chrome / хром	ZnAl



Mocowanie K90
 Fixture K90
 Крепление K90

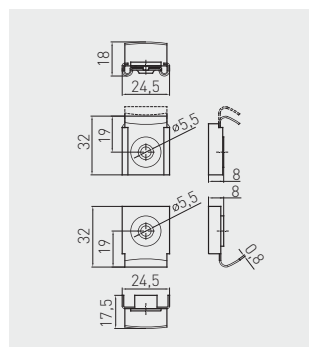

		
MC-K090-AR-01	chrom / chrome / хром	stal / steel / сталь



Mocowanie K91
 Fixture K91
 Крепление K91

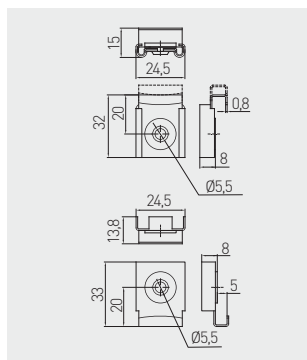

MC-K091-SQ-01



chrom / chrome / хром



stal / steel / сталь



Podpórka GL
 Shelf support GL
 Полкодержатель GL

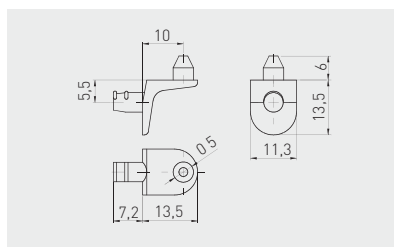

PP-GL-DR5-01



chrom / chrome / хром



ZnAl



Podpórka SAFETY
Shelf support SAFETY
Полкодержатель SAFETY

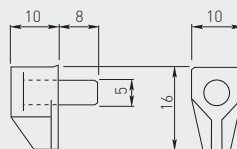

PP-SPL001-01	przeźroczysty transparent прозрачный	stal, tworzywo steel, plastic сталь, пластмасса



Podpórka MR-11
Shelf support pin MR-11
Полкодержатель MR-11

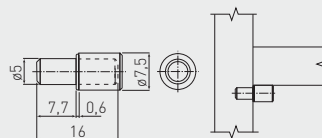

MR-ZSL011-01	z nakładką with plastic coating с накладкой	chrom / chrome / хром	stal / steel / сталь
MR-TDL011-01	bez nakładki without plastic coating без накладки		



Podpórka SMART Shelf support SMART Полкодержатель SMART

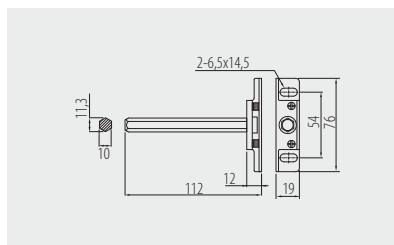

PP-SMART-000

srebrny / silver / серебристый

stal / steel / сталь



Podpórka CLEAR Shelf support CLEAR Полкодержатель CLEAR

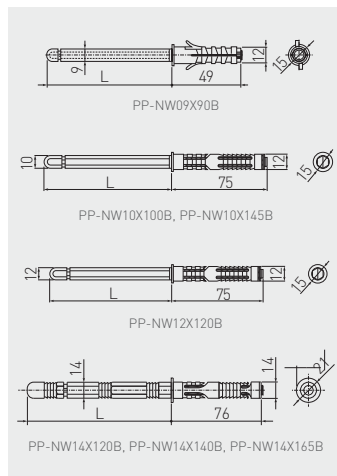

	mm	mm	kg			
PP-NW09X90B	9	90	10	brąz brown коричневый	stal steel сталь	200
PP-NW10X100B	10	110	15			
PP-NW10X145B	10	145	15			
PP-NW12X120B	12	120	15			100
PP-NW14X120B	14	120	25			
PP-NW14X140B	14	140	25			
PP-NW14X165B	14	165	25			



Podpórka LUK pod półkę
Shelf support bracket LUK
Полкодержатель LUK

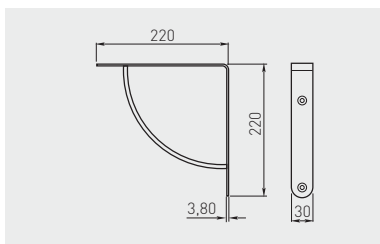

PP-LUK-00-01		30 / 2 szt.	chrom / chrome / хром	stal steel сталь
PP-LUK-00-02		30 / 2 pcs	satyna / satin / сатин	
PP-LUK-00-05		30 / 2 шт.	aluminium / aluminium / алюминий	



Podpórka WB-24 pod półkę
Shelf support bracket WB-24
Полкодержатель WB-24

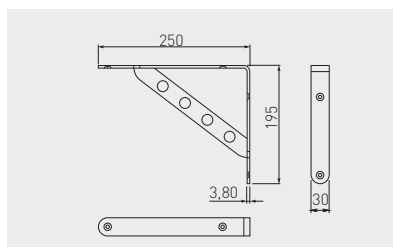

WB-073024-01		30 / 2 szt.	chrom / chrome / хром	stal / steel / сталь
WB-073024-06		30 / 2 pcs	stal szczotkowana / brushed steel / шлифованная сталь	
		30 / 2 шт.		



Podpórka WB-25 pod półkę
Shelf support bracket WB-25
Полкодержатель WB-25

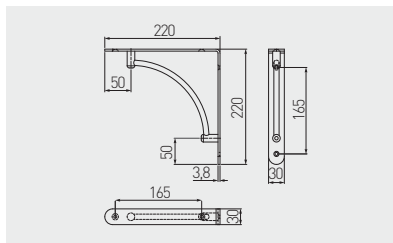

WB-073025-01	30 / 2 szt. 30 / 2 pcs	chrom / chrome / хром	stal / steel / сталь
WB-073025-06	30 / 2 шт.	stal szczotkowana / brushed steel / шлифованная сталь	



Podpórka WB-26 pod półkę
Shelf support bracket WB-26
Полкодержатель WB-26

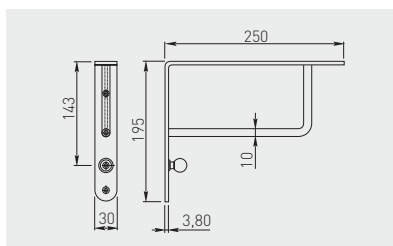

WB-073026-01	30 / 2 szt. 30 / 2 pcs	chrom / chrome / хром	stal / steel / сталь
WB-073026-06	30 / 2 шт.	stal szczotkowana / brushed steel / шлифованная сталь	



Podpórka WS12 Shelf support bracket WS12 Полкодержатель WS12

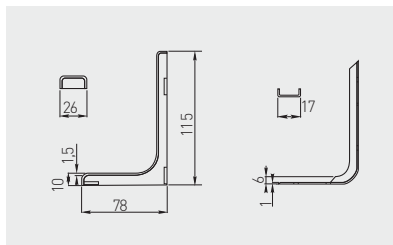

		 L mm	 kg		
WB-WS-12-010		120	8 / 2 szt. 8 / 2 pcs 8 / 2 шт.	biały / white / белый	tworzywo plastic пластмасса
WB-WS-12-020	czarny / black / чёрный				
WB-WS-12-031	ciemny brąz / dark brown / темно-коричневый				
WB-WS-12-032	jasny brąz / light brown / светло-коричневый				
WB-WS-12-033	kalwados / calvados / кальвадос				
WB-WS-12-060	szary / gray / серый				



Podpórka WS18 Shelf support bracket WS18 Полкодержатель WS18

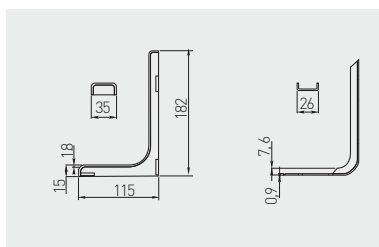

		 L mm	 kg		
WB-WS-18-010		180	9,5 / 2 szt. 9,5 / 2 pcs 9,5 / 2 шт.	biały / white / белый	tworzywo plastic пластмасса
WB-WS-18-020		180		czarny / black / чёрный	
WB-WS-18-030		180		brąz / brown / коричневый	
WB-WS-18-031		180		ciemny brąz / dark brown / темно-коричневый	
WB-WS-18-032		180		jasny brąz / light brown / светло-коричневый	
WB-WS-18-033		180		kalwados / calvados / кальвадос	
WB-WS-18-060		180		szary / gray / серый	



Podpórka WS24
Shelf support bracket WS24
Полкодержатель WS24

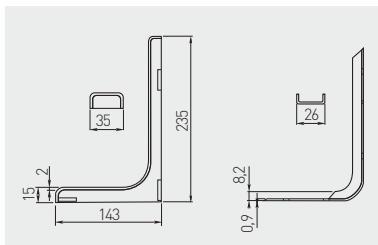





		 L mm	 kg		
WB-WS-24-010		240	11 / 2 szt. 11 / 2 pcs 11 / 2 шт.	biały / white / белый	tworzywo plastic пластмасса
WB-WS-24-020		240		czarny / black / чёрный	
WB-WS-24-030		240		brąz / brown / коричневый	
WB-WS-24-031		240		ciemny brąz / dark brown / темно-коричневый	
WB-WS-24-032		240		jasny brąz / light brown / светло-коричневый	
WB-WS-24-033		240		kalwados / calvados / кальвадос	
WB-WS-24-060		240		szary / gray / серый	

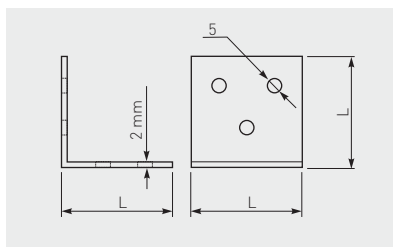





Kątownik FS01 szeroki
Angle bracket FS01
Широкий крепежный уголок FS01

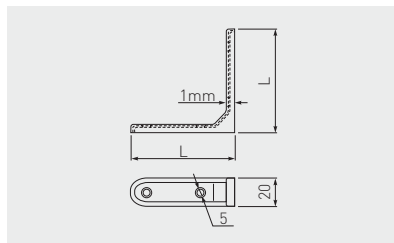

		 L mm			
KW-FS0125-01		25 x 25 x 24	chrom / chrome / хром	stal / steel / сталь	1500
KW-FS0140-01		40 x 40 x 40			400

Kątownik FS03 wzmacniany
 Angle bracket FS03 reinforced
 Усиленный крепежный уголок FS03



	 L mm			
KW-FS0335-01	35 x 35 x 20	chrom / chrome / хром	stal / steel / сталь	1300
KW-FS0350-01	50 x 50 x 20			700
KW-FS0375-01	75 x 75 x 20			400

Kątownik FS04 standardowy
 Angle bracket FS04 standard
 Стандартный крепежный уголок FS04

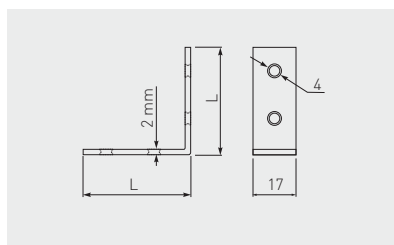

	 L mm			
KW-FS0425-03	25 x 25 x 17	mosiądz / brass / латунь	stal / steel / сталь	1500
KW-FS0430-03	30 x 30 x 17			1400
KW-FS0440-03	40 x 40 x 17			800
KW-FS0450-03	50 x 50 x 17			600
KW-FS0460-03	60 x 60 x 17			500
KW-FS0475-03	75 x 75 x 17			400

Kątownik FS06 narożnikowy
 Corner bracket FS06
 Угловой крепежный уголок FS06

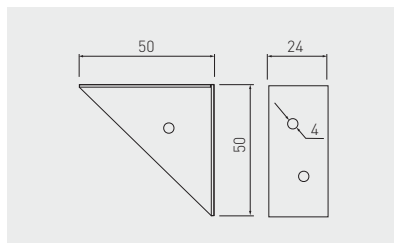

KW-FS0650-01

50 x 50 x 24

chrom / chrome / хром

stal / steel / сталь



Narożnik MONT pojedynczy
 Corner bracket MONT single
 Одинарный уголок MONT

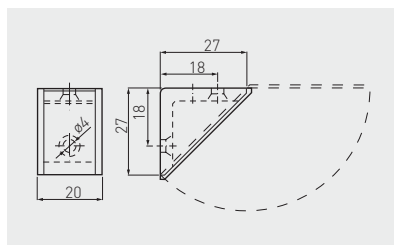

PP-PMONT0M-01	biały / white / белый	tworzywo plastic пластмасса
PP-PMONT0M-07	ciemny brąz / dark brown / темно-коричневый	
PP-PMONT0M-08	szary / gray / серый	
PP-PMONT0M-11	czarny / black / чёрный	
PP-PMONT0M-22	kość stoniowa / ivory / слоновая кость	



Narożnik MONT podwójny Corner bracket MONT double Двойной уголок MONT

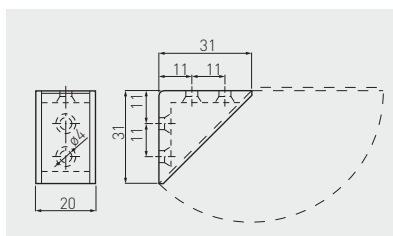

PP-PMONT0D-01	biały / white / белый	tworzywo plastic пластмасса
PP-PMONT0D-07	jasny brąz / light brown / светло-коричневый	
PP-PMONT0D-08	szary / gray / серый	
PP-PMONT0D-11	czarny / black / чёрный	
PP-PMONT0D-20	mahoń / mahogany / красное дерево	
PP-PMONT0D-22	kość stoniowa / ivory / слоновая кость	
PP-PMONT0D-41	olcha / alder / ольха	
PP-PMONT0D-50	beż / beige / бежевый	
PP-PMONT0D-724	wiśnia / cherry / вишня	
PP-PMONT0D-732	ciemny brąz / dark brown / темно-коричневый	



Narożnik NARS pojedynczy Corner bracket NARS single Одинерный уголок NARS

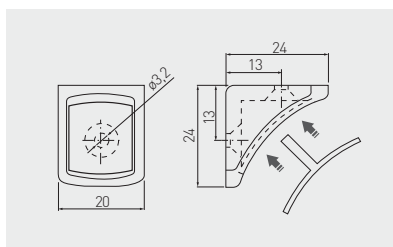

PM-NAR1003-512	kość stoniowa / ivory / слоновая кость	tworzywo plastic пластмасса
PM-NAR1003-645	szary / gray / серый	
PM-NAR1003-677	czarny / black / чёрный	
PM-NAR1003-680	biały / white / белый	
PM-NAR1003-695	srebrny / silver / серебристый	
PM-NAR1003-725	jasny brąz / light brown / светло-коричневый	
PM-NAR1003-728	beż / beige / бежевый	
PM-NAR1003-731	mahoń / mahogany / красное дерево	
PM-NAR1003-732	ciemny brąz / dark brown / темно-коричневый	
PM-NAR1003-770	grusza / pear / груша	
PM-NAR1003-771	olcha / alder / ольха	



Narożnik NARS podwójny Corner bracket NARS double Двойной уголок NARS

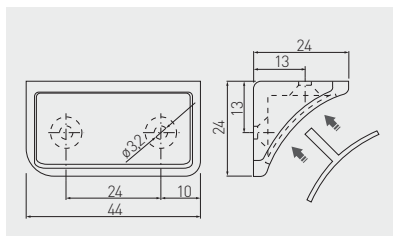

PM-NAR1004-512	kość stoniowa / ivory / слононая кость	tworzywo plastic пластмасса
PM-NAR1004-645	szary / gray / серый	
PM-NAR1004-677	czarny / black / чёрный	
PM-NAR1004-680	biały / white / белый	
PM-NAR1004-695	aluminium / aluminium / алюминий	
PM-NAR1004-724	wiśnia / cherry / вишня	
PM-NAR1004-725	jasny brąz / light brown / светло-коричневый	
PM-NAR1004-728	beż / beige / бежевый	
PM-NAR1004-732	ciemny brąz / dark brown / темно-коричневый	
PM-NAR1004-770	grusza / pear / груша	
PM-NAR1004-771	olcha / alder / ольха	



Stabilizator ścianki tylnej Rear stabilizer Стабилизатор задней стенки

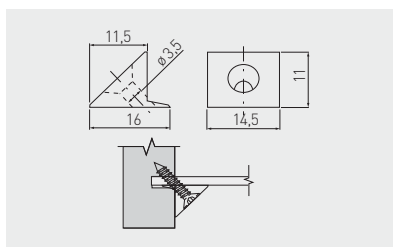

WZ-SCTYLPR-WK	z wkrętem 3,5 x 20 with screw 3,5 x 20 с шурупом 3,5 x 20	biały white белый	tworzywo plastic пластмасса
WZ-SCTYLPR-BWK	bez wkręta without screw без шурупа		



Zawieszka niewidoczna FORCE
Invisible kitchen hanger FORCE
Скрытый навес FORCE

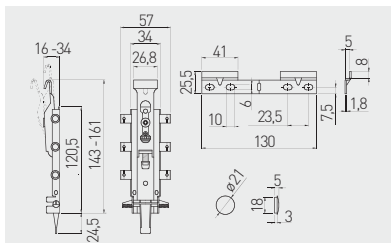

ZK-FORCE-KPL	100 / 2 szt. 100 / 2 pcs. 100 / 2 шт.	srebrny / silver / серебристый	ZnAl, stal / ZnAl, steel / ZnAl, сталь
--------------	---	--------------------------------	--



Zawieszka kuchenna R0 z regulacją
Kitchen hanger R0 adjustable
Навес кухонный R0 с регулировкой

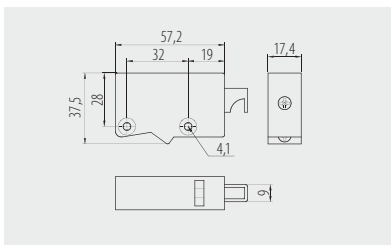

ZK-ZAW-R0-10	50 / 2 szt. 50 / 2 pcs.	biały / white / белый	stal, tworzywo steel, plastic сталь, пластмасса
ZK-ZAW-R0-30	50 / 2 шт.	brąz / brown / коричневый	



Zawieszka kuchenna R1
Kitchen hanger R1
Навес кухонный R1

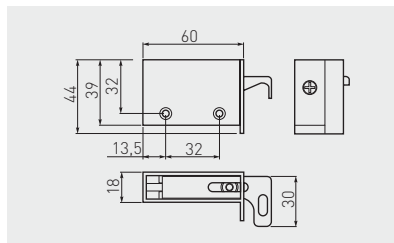

ZK-R1-KPL-10	90 / 2 szt. 90 / 2 pcs	biały / white / белый	stal, tworzywo steel, plastic
ZK-R1-KPL-30	90 / 2 szt.	brąz / brown / коричневый	stal, plastmаса



Zawieszka kuchenna STRONG
Kitchen hanger STRONG
Навес кухонный STRONG

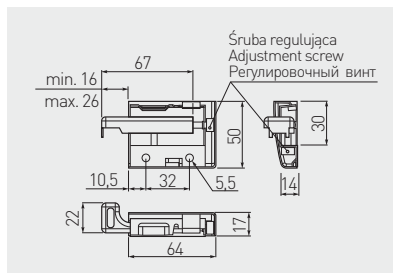

ZK-STRONG-KPL	130 / 2 szt. 130 / 2 pcs 130 / 2 шт.	1 kpl. = L+P 1 set = L+R 1 комп. = Л+П	srebrny silver серебристый	stal, tworzywo steel, plastic сталь, пластмаса



Zaślepka do zawieszki STRONG
 Hanger caps STRONG
 Заглушки для навесов STRONG

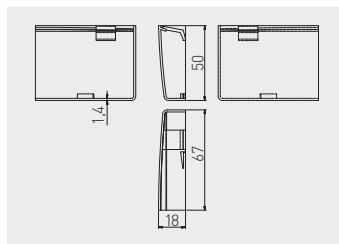

ZK-ZAS-KPL-10	1 kpl. = L+P 1 set = L+R 1 комп. = Л+П	biały / white / белый	
ZK-ZAS-KPL-31		ciemny brąz / dark brown / темно-коричневый	
ZK-ZAS-KPL-32		jasny brąz / light brown / светло-коричневый	
		tworzywo plastic пластмасса	



Listwa montażowa
 Mounting strip
 Монтажная планка

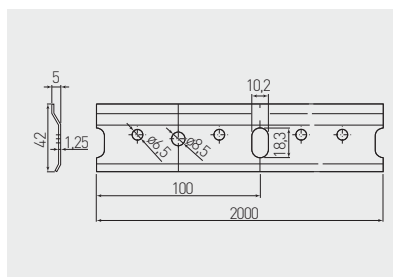

LO-M2M-00-125	2000 mm	ocynk galvanized гальваника	stal steel сталь



Złącze do blatów śrubowe
Concealed worktop connector
Стяжка для столешниц

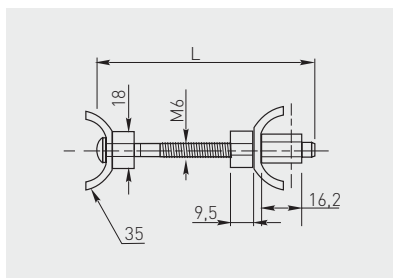

		 L mm		
EM-SBL060-01		60	chrom / chrome / хром	stal, tworzywo steel, plastic сталь, пластмасса
EM-SBL100-01		100		
EM-SBL150-01		150		



Złącze mimośrodowe do półek
Eccentric connecting fitting for shelves
Эксцентриковая стяжка для полок

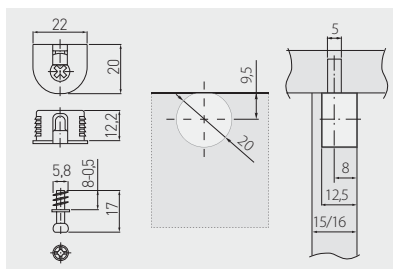

		 mm			
MM-FI20X6X7-PL10		20	trzcpień 6 x 7 mm dowel 6 x 7 mm штифт 6 x 7 мм	biały / white / белый	ZnAl, tworzywo ZnAl, plastic ZnAl, пластмасса
MM-FI20X6X7-PL20				czarny / black / чёрный	
MM-FI20X6X7-PL30				brąz / brown / коричневый	
MM-FI20X6X7-PL80				szary / gray / серый	
MM-FI20X6X7-ZN				srebrny / silver / серебристый	



Złącze mimośrodowe do półek
 Eccentric connecting fitting for shelves
 Экцентриковая стяжка для полок

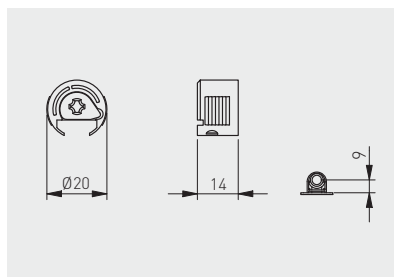

	 mm		
MM-FI20-KPL	Ø20	biały / white / белый	stal, tworzywo steel, plastic сталь, пластмасса







Szybkozłącze
 Threaded sleeve, with internal thread
 Стяжки

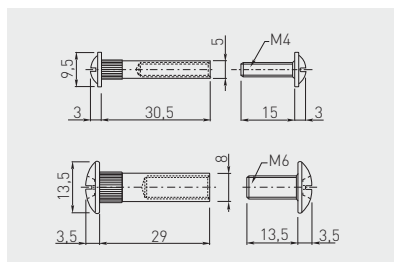

SZ-005-00-01T
 SZ-008-00-01T

SZ-005-00-01-A
 SZ-008-00-01-A



	 mm		
SZ-005-00-01T	5	chrom / chrome / хром	stal / steel / сталь
SZ-005-00-01-A			
SZ-008-00-01T	8		
SZ-008-00-01-A			



Złącze spiralne fi 35 do mocnych połączeń

Spiral connector, Fi 35, for strong connections

Крепеж спиральный диаметр 35 для прочных соединений

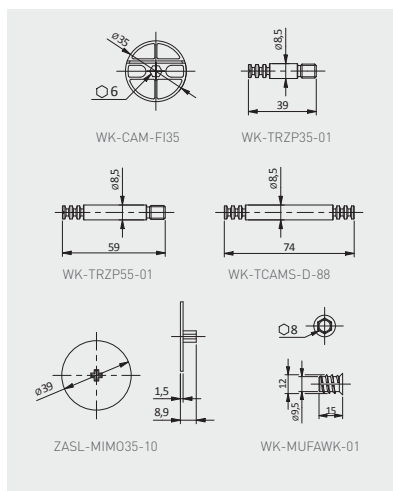







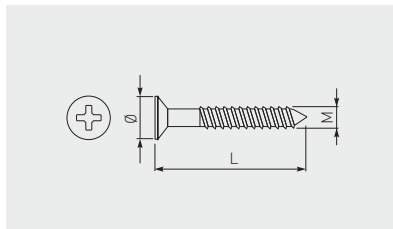

WK-CAM-FI35	Złącze spiralne fi 35 do mocnych połączeń Spiral connector, Fi 35, for strong connections Крепеж спиральный диаметр 35 для прочных соединений	szary / gray / серый	
WK-MUFAWK-01	Mufa wkręcana z kotnierzem stożkowym M8 x 15 Screwed cone nut M8 x 15 Муфта винчиваемая с конусным фланцем M8 x 15		
WK-TCAMS-D-88	Trzepień dwustronny do złącza spiralnego M8 L35 Double bolt for spiral connector M8 L35 Шток двухсторонний для спирального крепежа M8 L35	srebrny silver серебристый	stal steel сталь
WK-TRZP35-01	Trzpień do złącza spiralnego M8 L35 Bolt for for spiral connector M8 L35 Шток для спирального крепежа M8 L35		
WK-TRZP55-01	Trzpień do złącza spiralnego M8 L55 Bolt for eccentric connecting fitting M8 L55 Шток эксцентрика M8 L55		
ZASL-MIMO35-10	Zaślepka fi 35 end cap fi 35 заглушка fi 35	biały / white / белый	tworzywo plastic пластмасса



Wkręt do drewna
Screw for wood
Мебельные метизы



		 mm		
WK-D0310-001		3 x 10	chrom chrome хром	stal steel сталь
WK-D0313-001		3 x 13		
WK-D0316-001		3 x 16		
WK-D0320-001*		3 x 20		
WK-D0325-001*		3 x 25		
WK-D0330-001*		3 x 30		
WK-D0416-001		4 x 16		
WK-D0425-001*		4 x 25		

		 mm		
WK-D0430-001		4 x 30	chrom chrome хром	stal steel сталь
WK-D0440-001*		4 x 40		
WK-D0460-001*		4 x 60		
WK-D3516-001		3,5 x 16		
WK-D3525-001		3,5 x 25		
WK-D3530-001		3,5 x 30		

* Produkt dostępny na indywidualne zamówienie
* Available for special orders
* Товар доступен под заказ



Mimośród F115X12mm
Eccentric connecting fitting F115X12mm
Эксцентрик F115X12mm

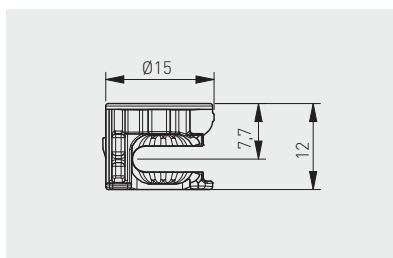

Produkt kompatybilny z zawiasem barkowym: WK-DOW63X45-P
Compatible with flap hinge: WK-DOW63X45-P
Продукт совместим с барной петлей: WK-DOW63X45-P

		 mm		
WK-CAM-15-12-PE		Ø15 x 12	chrom / chrome / хром	ZnAl



Mimośród F115x13 mm
 Eccentric connecting fitting F115x13 mm
 Эксцентрик F115x13 mm

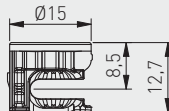

	 mm		
WK-CAM-15-13-P	Ø15 x 13	chrom / chrome / хром	ZnAl



Trzpień do mimośrod
 Bolt for eccentric connecting fitting
 Шток эксцентрика

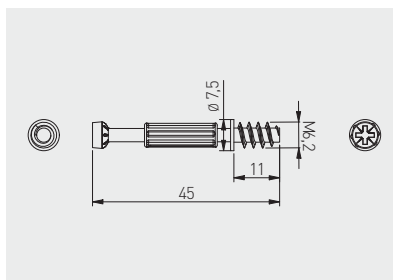

			
WK-DOW63X45-P	6,3 x 45	srebrny, niebieski silver, blue серебряный, синий	stal, tworzywo steel, plastic сталь, пластмасса



Konfirmat*
 Confirmat screw*
 Конфирмат*

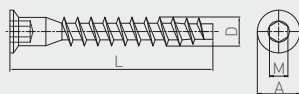

	L	D	A	M
WK-CF6450-01	6,4 x 50	50	6,4	4
WK-CF0750-01	7 x 50	50	7	4



WK-CF6450-01	chrom / chrome / хром	stal / steel / сталь
WK-CF0750-01		



* Produkt dostępny na indywidualne zamówienie / Available for special orders / Товар доступен под заказ

Magnes MENSA
 Magnetic catch MENSA
 Магнит MENSA

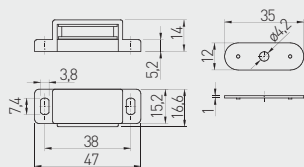





MG-MENSA-010	biały / white / белый	stal, tworzywo steel, plastic сталь, пластмасса
MG-MENSA-030	brąz / brown / коричневый	

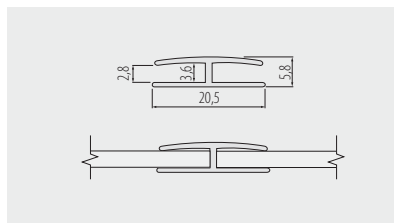

Profil meblowy PFM – typ H
 Furniture edge profile PFM – type H
 Мебельный профиль PFM – тип H



	 mm		
PM-PFMH51-10*	2000	ciemny brąz / dark brown / темно-коричневый	tworzywo plastic пластмасса
PM-PFMH53-10	2000	jasny brąz / light brown / светло-коричневый	
PM-PFMH61-10*	2000	ciemny mahoń / dark mahogany / темное красное дерево	
PM-PFMH64-10	2000	mahoń / mahogany / красное дерево	
PM-PFMH69-10	2000	beż / beige / бежевый	
PM-PFMH50-24*	2400	biały / white / белый	
PM-PFMH50-25*	2500	biały / white / белый	
PM-PFMH55-25*	2500	czarny / black / чёрный	
PM-PFMH64-25*	2500	mahoń / mahogany / красное дерево	



* Produkt dostępny na indywidualne zamówienie / Available for special orders / Товар доступен под заказ

Listwa ozdobna płaska
Flat decorative strip
Плоская декоративная планка

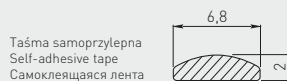

Taśma samoprzylepna
Self-adhesive tape
Самоклеящаяся лента

	 L mm		
LO-00-00-001	2000	chrom / chrome / хром	tworzywo plastic пластмасса
LO-00-00-003	2000	mosiądz / brass / латунь	



Listwa ozdobna wypukła
Convex decorative strip
Выпуклая декоративная планка

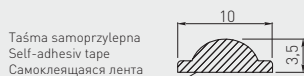

Taśma samoprzylepna
Self-adhesive tape
Самоклеящаяся лента





	 L mm		
LO-P0-00-010	2000	biały / white / белый	tworzywo plastic пластмасса
LO-P0-00-030	2000	brąz / brown / коричневый	

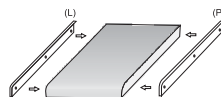

Listwa boczna 38
Worktop edging strip 38
Торцевая планка 38



Do blatów o grubości 38 mm
For worktops 38 mm thick
Для столешниц толщиной 38 мм



				
LMB-BOCZ38L-ALU	lewa / left / левая	600	aluminium aluminium алюминий	aluminium aluminium алюминий
LMB-BOCZ38P-ALU	prawa / right / правая			

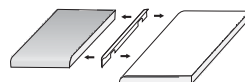

Listwa kąтова 28
Worktop angle edging strip 28
Угловая планка 28



Do blatów o grubości 28 mm
For worktops 28 mm thick
Для столешниц толщиной 28 мм

			
LMB-KAT28-ALU	600	aluminium aluminium алюминий	aluminium aluminium алюминий



Listwa kątowna 38
Worktop angle edging strip 38
Угловая планка 38

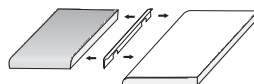

Do blatów o grubości 38 mm
For worktops 38 mm thick
Для столешниц толщиной 38 мм

	 L mm		
LMB-KAT38-ALU	600	aluminium aluminium алюминий	aluminium aluminium алюминий



Listwa szczelinowa 28
Worktop joining strip 28
Щелевая планка 28

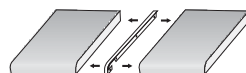

Do blatów o grubości 28 mm
For worktops 28 mm thick
Для столешниц толщиной 28 мм

	 L mm		
LMB-SZCZ28-ALU	600	aluminium aluminium алюминий	aluminium aluminium алюминий



Listwa szczelinowa 38
Worktop joining strip 38
Щелевая планка 38

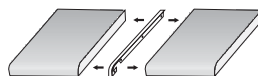

Do blatów o grubości 38 mm
For worktops 38 mm thick
Для столешниц толщиной 38 мм

	 L mm		
LMB-SZCZ38-ALU	600	aluminium aluminium алюминий	aluminium aluminium алюминий



Drażek owalny
Oval wardrobe rail
Овальная труба для гардероба

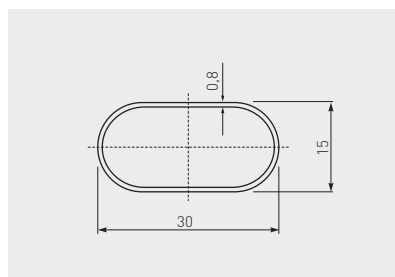

	 L mm		
RR-CH-OW-000	3000	chrom / chrome / хром	stal / steel / сталь



Mocowanie RDR do drążka owalnego
RDR mounting bracket for oval wardrobe rail
Крепление RDR для овальной трубы

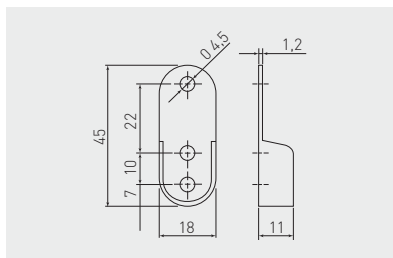

MR-RDRO-0000



chrom / chrome / хром



stal / steel / сталь



Uchwyt WP-28 do rury owalnej
WP-28 angle bracket for oval rail
Крепление дистанционное для овальной трубы WP-28

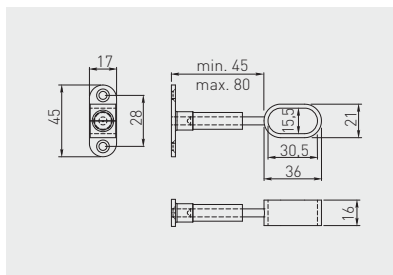

MR-WP-028-01



chrom / chrome / хром





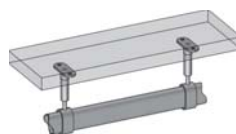



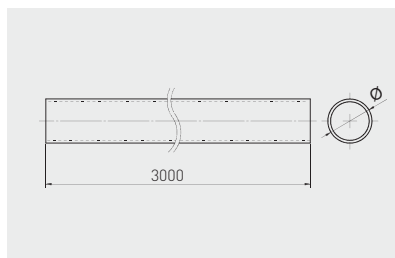





ZnAl



Драżек okrągły
Round wardrobe rail
Мебельная штанга



		 mm	 mm	 mm		
RR-161030H01		16	1	3000	chrom chrome хром	stal steel сталь
RR-161230H01		16	1,2			
RR-250730H01		25	0,7			
RR-250830H01		25	0,8			
RR-250930H01		25	0,9			

		 mm	 mm	 mm		
RR-251030H01		25	1	3000	chrom chrome хром	stal steel сталь
RR-401230H01*		40	1,2			
RR-501030H01		50	1			
RR-501230H01		50	1,2			



* Produkt dostępny na indywidualne zamówienie / Available for special orders / Товар доступен под заказ

Mocowanie R-25 do drażka okrągłego
R-25 mounting bracket for round rail
Крепление R-25 для трубы

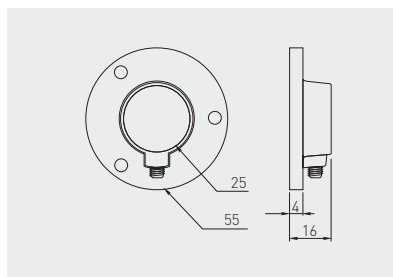



		 mm		
MR-RS025-001		25	chrom / chrome / хром	stal / steel / сталь

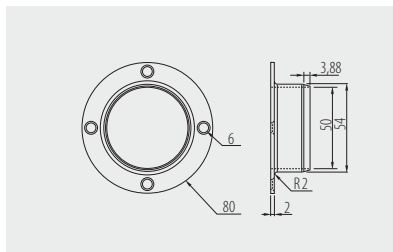

Монование R-50 do drążka okrągłego
R-50 mounting bracket for round rail
Крепление R-50 для трубы







	 mm		
MR-R0050-001	50	chrom / chrome / хром	stal / steel / сталь

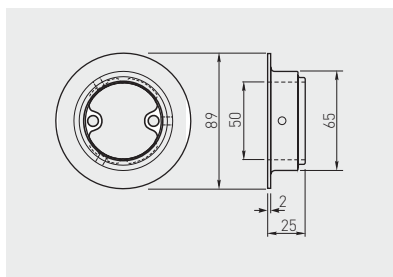

Монование PZ-2 dolne do drążka okrągłego
PZ-2 bottom mounting bracket for round rail
Нижнее крепление PZ-2 для трубы



	 mm		
MR-WPZ002-01	50	chrom / chrome / хром	stal / steel / сталь



Pierścień mocujący PZ-3
Mounting ring PZ-3
Крепёжное кольцо PZ-3

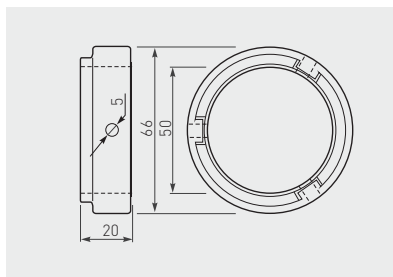

	 mm		
MR-WPZ003-01	50	chrom / chrome / хром	ZnAl



Uchwyt WP-10 dystansowy, regulowany
WP-10 support bracket, adjustable
Регулируемый кронштейн WP-10

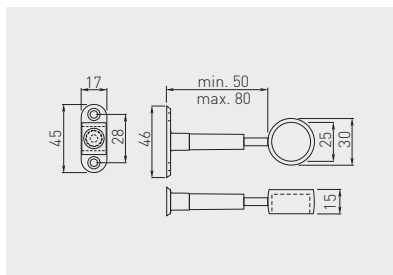

	 mm		
MR-WP-010-01	25	chrom / chrome / хром	ZnAl



Uchwyt WP-11 dystansowy, regulowany z zaślepką
 WP-11 support bracket, adjustable with cover
 Регулируемый кронштейн WP-11 с заглушкой

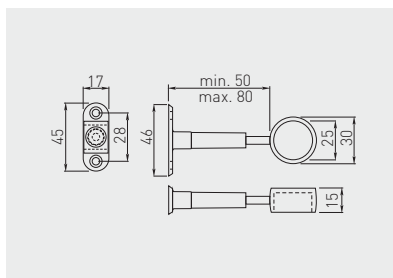

	 mm		
MR-WP-011-01	25	chrom / chrome / хром	ZnAl



Uchwyt THA-12 dystansowy, przelotowy
 THA-12 support bracket
 Опорный кронштейн THA-12 сквозной

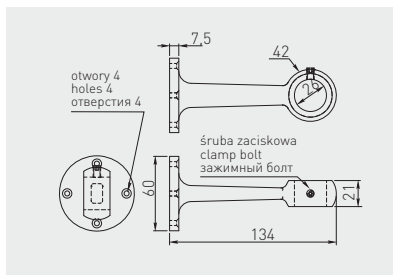

	 mm		
MR-THA12-001	25	chrom / chrome / хром	ZnAl



Uchwyt THB-12 dystansowy
 THB-12 support bracket
 Опорный кронштейн THB-12

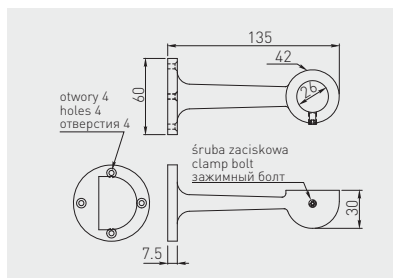

	 mm		
MR-THB12-001	25	chrom / chrome / хром	ZnAl



Łącznik WP-13
 WP-13 connector
 Соединитель WP-13

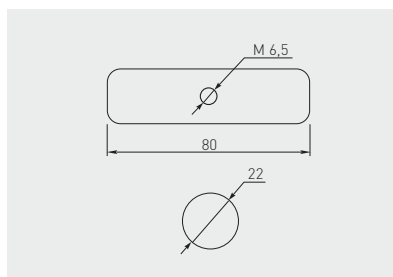

		
MR-WP013-001	ocynk / galvanized / гальваника	ZnAl



Złącze TH-5 dwuramienne
 TH-5 connector
 Муфта TH-5 двухраструбная

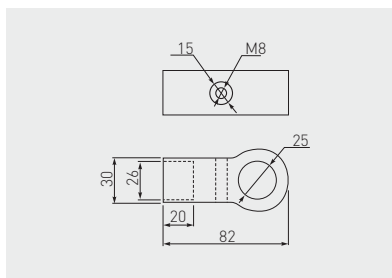

	 mm		
MR-TH005-001	25	chrom / chrome / хром	ZnAl



Złącze TH-16 dwuramienne
 TH-16 connector
 Муфта двухраструбная TH-16

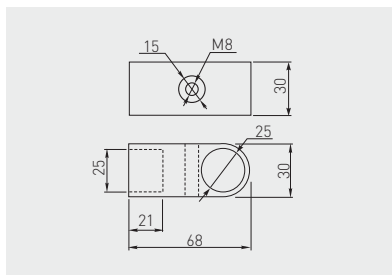

	 mm		
MR-TH016-001	25	chrom / chrome / хром	ZnAl



Złącze TH-4 dwuramienne typ T
 TH-4 connector type T
 Муфта TH-4 двухраструбная тип T

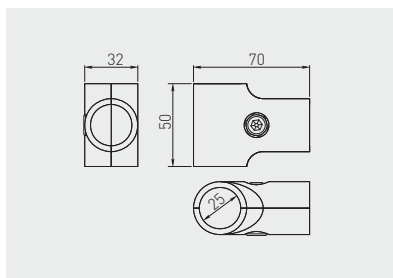

	 mm		
MR-TH004-001	25	chrom / chrome / хром	ZnAl



Zestaw złączy TH-18 typ L
 TH-18 connector type L
 Набор муфт TH-18 тип L

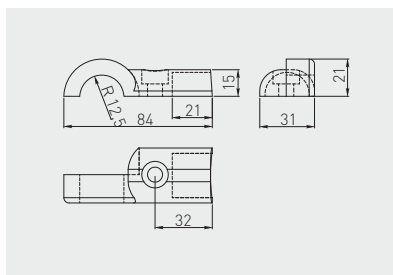

Możliwość uzyskania różnych położeń połączenia
 The possibility of obtaining various positions of connection
 Возможность получения разных положений соединения

		 mm		
MR-TH018-KPL	prawy / lewy right / left правый / левый	25	chrom / chrome / хром	ZnAl



Zestaw złączy T-18 typ T
T-18 connectors set type T
Набор муфт ТН-18 тип Т

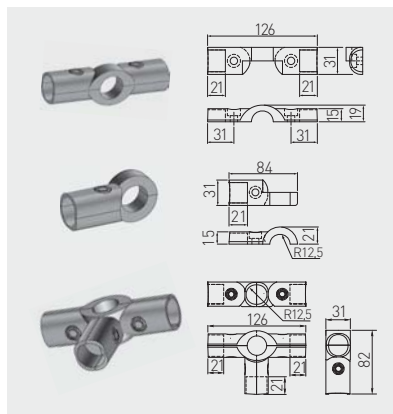

	 mm		
MR-T1824-KPL	25	chrom / chrome / хром	ZnAl

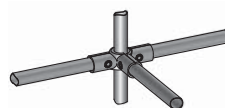

Zestaw złączy TH-24
TH-24 connectors set
Набор муфт ТН-24

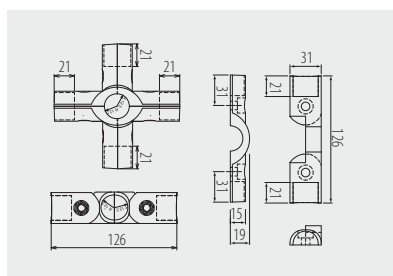

	 mm		
MR-TH024-KPL	25	chrom / chrome / хром	ZnAl



Złącze TH-11 zawiasowe
TH-11 hinge connector
Муфта шарнирная TH-11

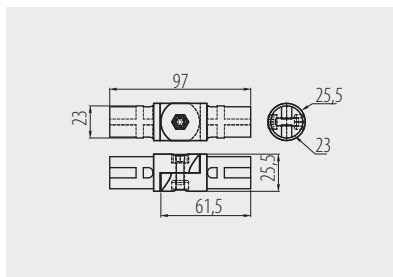

MR-TH011-001



chrom / chrome / хром



ZnAl



Możliwość dostosowania kąta złączy do założonego położenia (do 180°)

The possibility of adjustment of angle connector arms to the desired position (up to 180°)

Возможность регулировки угла стыковки соединителей к заданному положению [180°]

Złącze TH-9
TH-9 connector
Муфта TH-9

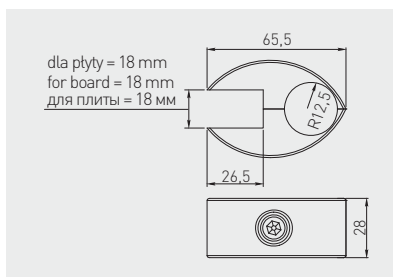

MR-TH009-001



chrom / chrome / хром



ZnAl



Zalecana grubość szkła z użyciem wkładek: 4 – 8 mm

Recommended glass thickness with inserts: 4 – 8 mm

Рекомендуемая толщина стекла с использованием вкладышей: 4 – 8 мм

Złącze TH-10 dwustronne
TH-10 connector
Муфта TH-10 двухсторонняя

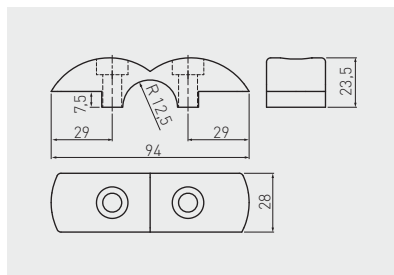

		
MR-TH010-001	chrom / chrome / хром	ZnAl



Zalecana grubość szkła z użyciem wkładek: 4 – 8 mm
Recommended glass thickness with inserts: 4 – 8 mm
Рекомендуемая толщина стекла с использованием вкладышей: 4 – 8 мм

Zestaw złączy TH-35
TH-35 set of connectors
Набор муфт TH-35

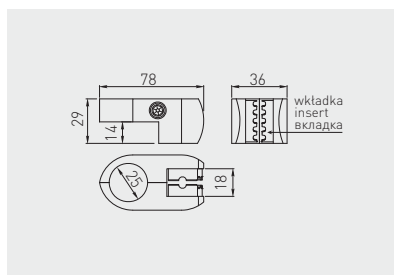

			
MR-TH035-KPL	25	chrom / chrome / хром	ZnAl



Zalecana grubość szkła z użyciem wkładek: 4 – 8 mm
Recommended glass thickness with inserts: 4 – 8 mm
Рекомендуемая толщина стекла с использованием вкладышей: 4 – 8 мм

Złącze WP-14 dwustronne
WP-14 connector
Муфта WP-14 двухсторонняя

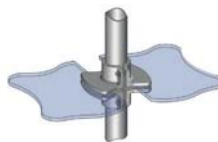
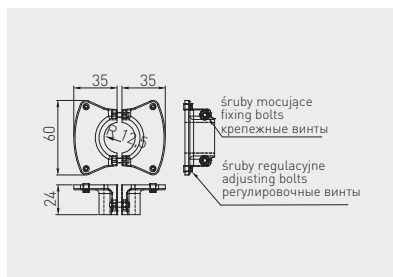

	 mm		
MR-WP-14-KPL	25	chrom / chrome / хром	ZnAl



Złącze WP-15
WP-15 connector
Муфта WP-15

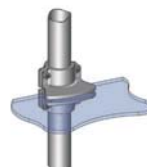
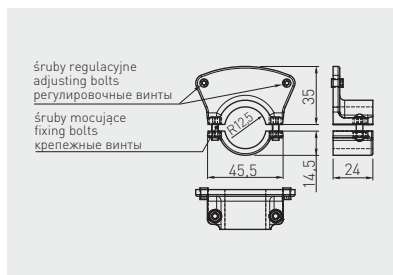

	 mm		
MR-WP-15-KPL	25	chrom / chrome / хром	ZnAl



Złącze TH-1 równoległe
 TH-1 connector parallel
 Муфта TH-1 равнопроходная

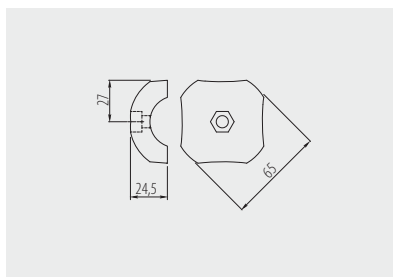

		
MR-TH001-01	chrom / chrome / хром	ZnAl



Złącze TH-2 potrójne
 TH-2 connector three-way
 Муфта TH-2 тройная

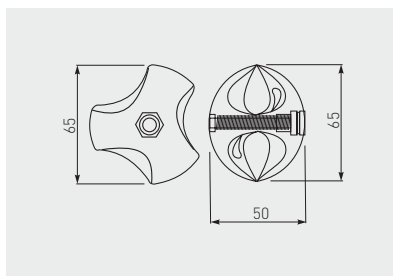

			
MR-TH002-L01	lewy / left / левый	chrom / chrome / хром	ZnAl
MR-TH002-P01	prawy / right / правый		



Złącze TH-18 podwójne
TH-18 double connector
Муфта TH-18 двойная

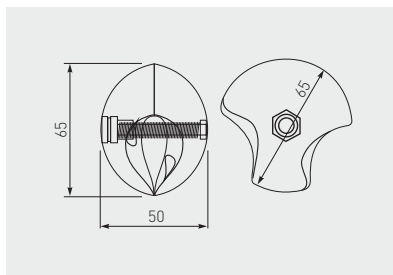

			
MR-TH018-L01	lewy / left / левый	chrom / chrome / хром	ZnAl
MR-TH018-P01	prawy / right / правый		



Zaślepka okrągła
Round end cap
Круглая заглушка

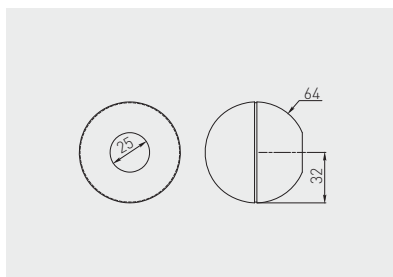

			
MR-THQZ1-001	25	chrom / chrome / хром	ZnAl



Zaślepka TH-19
TH-19 end cap
Заглушка TH-19

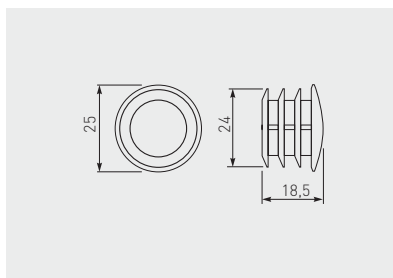

	 mm		
MR-TH019-001	25	chrom / chrome / хром	ZnAl



Stopka plastikowa zewnętrzna
Plastic end cap
Внешняя ножка, пластмассовая

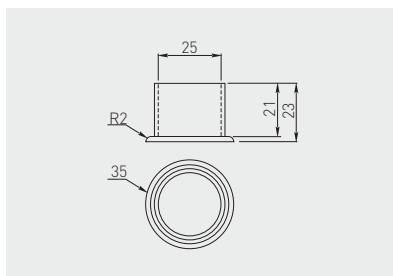

	 mm		
MR-TH019-003	25	czarny black чёрный	tworzywo plastic пластмасса



Uchwyt THA-48 z przyssawką
 THA-48 handle with suction cup
 Крепление THA-48 с присоской

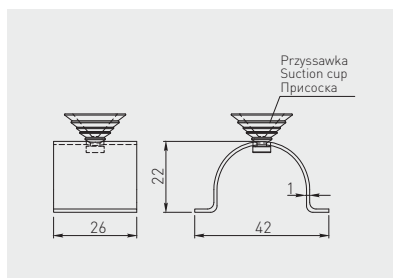

	 mm		
MR-TH048-001	25	chrom chrome хром	stal, tworzywo steel, plastic сталь, пластмасса



Mocowanie PZ-6 górne, rozporowe
 PZ-6 expandable end support bracket
 Верхнее крепление PZ-6

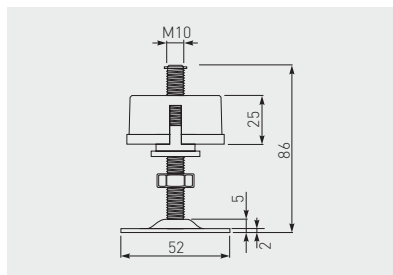

	 mm		
MR-WPZ006-01	50	chrom / chrome / хром	stal, tworzywo / steel, plastic / сталь, пластмасса



Uchwyt do relingu prosty
 Rail support
 Ручка для рейлинга прямая

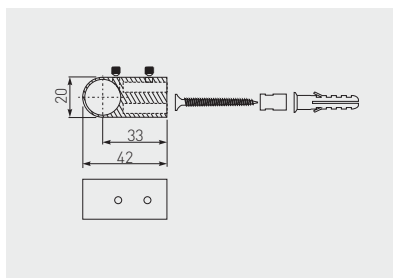

	 mm		
MR-WP2802-01	16	chrom / chrome / хром	ZnAl



Zaślepka do relingu prosta
 End cap
 Заглушка для рейлинга прямая

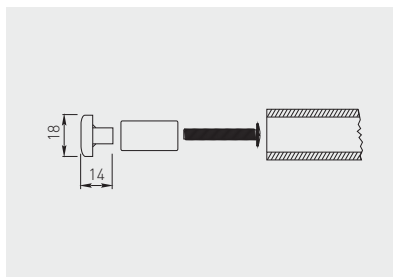

	 mm		
MR-WP2815-01	16	chrom / chrome / хром	ZnAl



Uchwyt do relingu
Rail support
Ручка для рейлінга

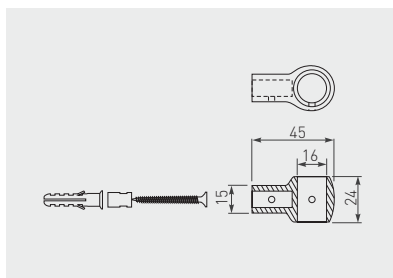

	 mm		
MR-WP2804-01	16	chrom / chrome / хром	ZnAl



Zaślepka do relingu
End cap
Заглушка для рейлінга

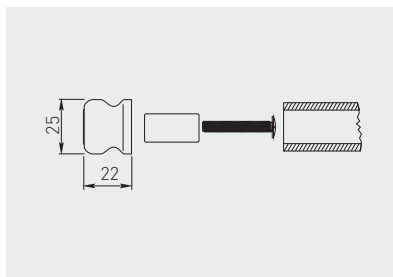

	 mm		
MR-WP2806-01	16	chrom / chrome / хром	ZnAl, tworzywo / ZnAl, plastic / ZnAl, пластмасса



Łącznik do relingu
 Rail connector
 Соединитель для рейлинга

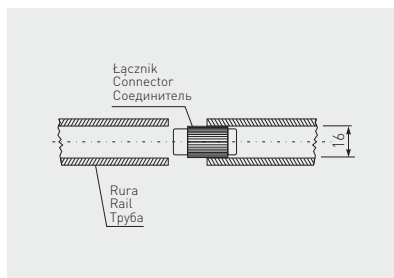

	 mm		
MR-WP2807-20	16	czarny / black / чёрный	tworzywo / plastic / пластмасса



Zaślepka do relingu z gwintem
 End cap with thread for rails
 Заглушка для рейлинга с резьбой

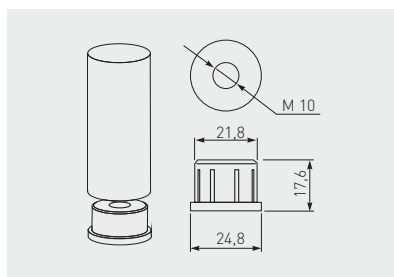

		
MR-WP2023-01	chrom / chrome / хром	ZnAl



Haczyki do relingu PS1
 Hooks for rails PS1
 Крючки для рейлинга PS1

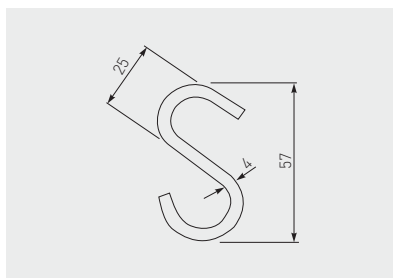

	 mm		
MR-WPS01-001	16	chrom / chrome / хром	stal / steel / сталь



Haczyki do relingu PS3
 Hooks for rails PS3
 Крючки для рейлинга PS3

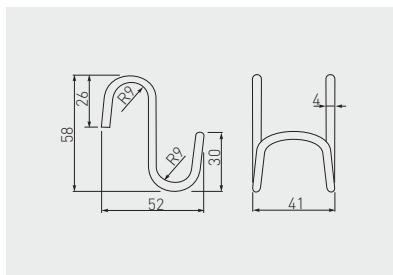





	 mm		
MR-WPS03-001	16	chrom / chrome / хром	stal / steel / сталь

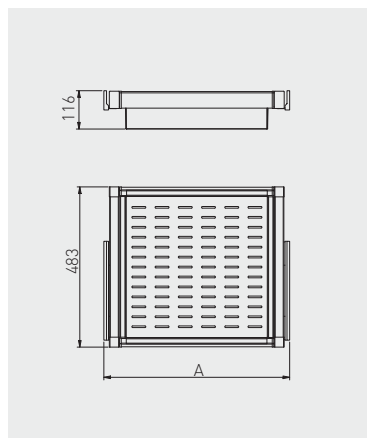

Kosz metalowy ELITE
 Metal basket ELITE
 Металлическая корзина ELITE





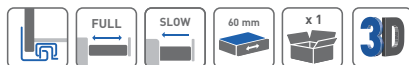

	A min./max.			
WG-KOSZM60-10	560 - 618	pełny full полное	biały white белый	stal, tworzywo steel, plastic сталь, пластмасса
WG-KOSZM70-10	660 - 718			
WG-KOSZM80-10	760 - 818			
WG-KOSZM90-10	860 - 918			
WG-KOSZM60-60	560 - 618		antracyt anthracite антрацит	
WG-KOSZM70-60	660 - 718			
WG-KOSZM80-60	760 - 818			
WG-KOSZM90-60	860 - 918			

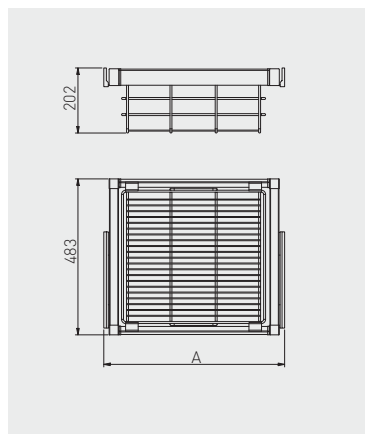

Kosz ażurowy ELITE
Openwork basket ELITE
Ажурная корзина ELITE





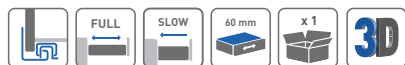

	A min./max.			
WG-KOSZ60-10	560 - 618	pełny full полное	biały white белый	stal, tworzywo steel, plastic сталь, пластмасса
WG-KOSZ70-10	660 - 718			
WG-KOSZ80-10	760 - 818			
WG-KOSZ90-10	860 - 918			
WG-KOSZ60-60	560 - 618		antracyt anthracite антрацит	
WG-KOSZ70-60	660 - 718			
WG-KOSZ80-60	760 - 818			
WG-KOSZ90-60	860 - 918			

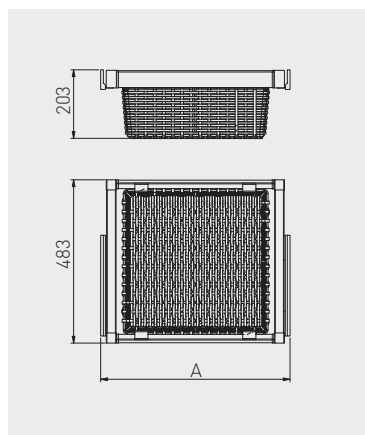

Kosz rattanowy ELITE
Rattan basket ELITE
Плетеная из rattana корзина ELITE





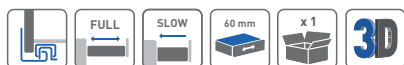

		A min./max.			
WG-KOSZR60-10		560 – 618		biały white белый	stal, tworzywo steel, plastic сталь, пластмасса
WG-KOSZR70-10		660 – 718			
WG-KOSZR80-10		760 – 818			
WG-KOSZR90-10		860 – 918			
WG-KOSZR60-60		560 – 618		antracyt anthracite антрацит	
WG-KOSZR70-60		660 – 718			
WG-KOSZR80-60		760 – 818			
WG-KOSZR90-60		860 – 918			

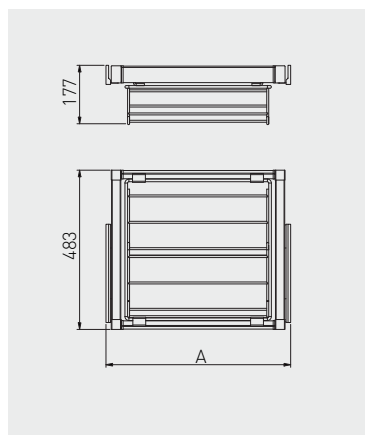

Szuflada ELITE na obuwie
 Pull out shoes rack ELITE
 Полка для обуви ELITE





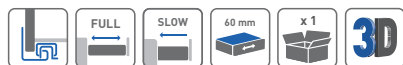

	A min./max.			
WG-POBUW60-10	560 – 618	pełny full полное	biały white белый	stal, tworzywo steel, plastic сталь, пластмасса
WG-POBUW70-10	660 – 718			
WG-POBUW80-10	760 – 818			
WG-POBUW90-10	860 – 918			
WG-POBUW60-60	560 – 618		antracyt anthracite антрацит	
WG-POBUW70-60	660 – 718			
WG-POBUW80-60	760 – 818			
WG-POBUW90-60	860 – 918			

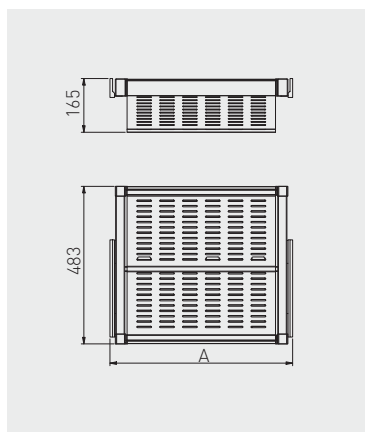

Szublada ELITE na obuwie metalowa
Metal pull out shoes rack ELITE
Металлическая полка для обуви ELITE





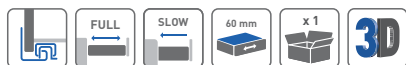

	A min./max.			
WG-POBUWM60-10	560 – 618	pełny full полное	biały white белый	stal, tworzywo steel, plastic сталь, пластмасса
WG-POBUWM70-10	660 – 718			
WG-POBUWM80-10	760 – 818			
WG-POBUWM90-10	860 – 918			
WG-POBUWM60-60	560 – 618		antracyt anthracite антрацит	
WG-POBUWM70-60	660 – 718			
WG-POBUWM80-60	760 – 818			
WG-POBUWM90-60	860 – 918			

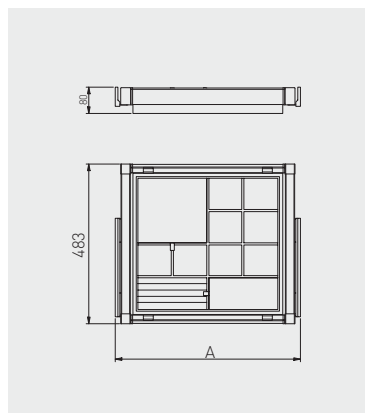

Organizer ELITE
Organiser ELITE
Органайзер ELITE





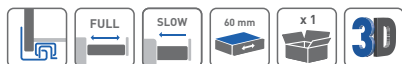

	A min./max.				
WG-PRZEG60-10	560 – 618	pełny full полное		biały white белый	
WG-PRZEG70-10	660 – 718				
WG-PRZEG80-10	760 – 818				
WG-PRZEG90-10	860 – 918				
WG-PRZEG60-60	560 – 618			antracyt anthracite антрацит	stal, tworzywo steel, plastic сталь, пластмасса
WG-PRZEG70-60	660 – 718				
WG-PRZEG80-60	760 – 818				
WG-PRZEG90-60	860 – 918				

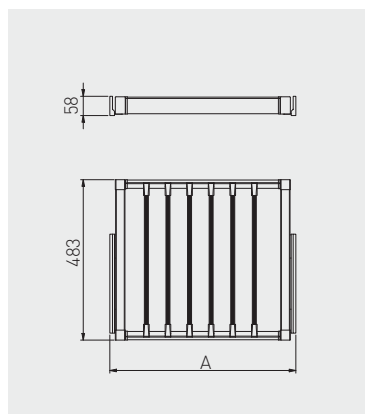

Wieszak ELITE na spodnie
 Wardrobe trouser rack ELITE
 Вешалка для брюк ELITE



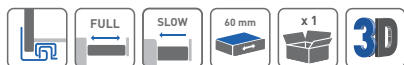

	A min./max.			
WG-WSP0D60-10	560 – 618	petny full полное	biały white белый	stal, tworzywo steel, plastic сталь, пластмасса
WG-WSP0D70-10	660 – 718			
WG-WSP0D80-10	760 – 818			
WG-WSP0D90-10	860 – 918			
WG-WSP0D60-60	560 – 618		antracyt anthracite антрацит	
WG-WSP0D70-60	660 – 718			
WG-WSP0D80-60	760 – 818			
WG-WSP0D90-60	860 – 918			

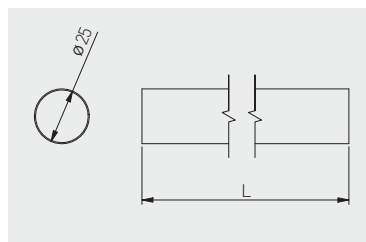

Drażek okrągły
Round wardrobe rail
Круглая мебельная штанга



		 mm		
RR-250930H10		3000	biały white белый	stal steel сталь
RR-250930H60			antracyt anthracite антрацит	



Rozetka okrągła
Wardrobe rail socket
Монтажный крепеж

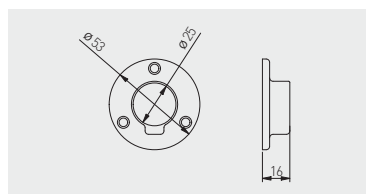

			
MR-RS025-10		biały white белый	stal steel сталь
MR-RS025-60		antracyt anthracite антрацит	



Drażek prostokątny
 Rectangular wardrobe rail
 Прямоугольная мебельная штанга

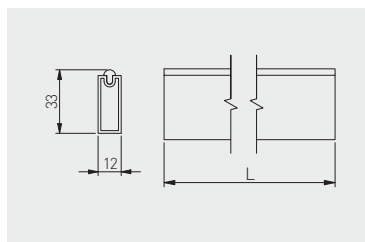





		 L mm		
WG-RRPS300-10		3000	biały white белый	aluminium, tworzywo aluminium, plastic алюминий, пластмасса
WG-RRPS300-60			antracyt anthracite антрацит	

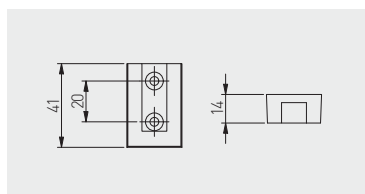

Rozetka prostokątna
 Rectangular wardrobe rail socket
 Прямоугольный монтажный крепеж



				
WG-RDRP-10		rozetka prostokątna z zaślepką rectangular wardrobe rail socket with end cap прямоугольный монтажный крепеж с заглушкой	biały white белый	ZnAl, tworzywo ZnAl, plastic ZnAl, пластмасса
WG-RDRP-60			antracyt anthracite антрацит	
WG-RDRO-10		rozetka prostokątna bez zaśleпки rectangular wardrobe rail socket without end cap прямоугольный монтажный крепеж без заглушки	biały white белый	stal steel сталь
WG-RDRO-60			antracyt anthracite антрацит	



Pantograf z podnośnikiem olejowym
 Pull-down wardrobe rail – oil
 Пантограф с масляным подъемником

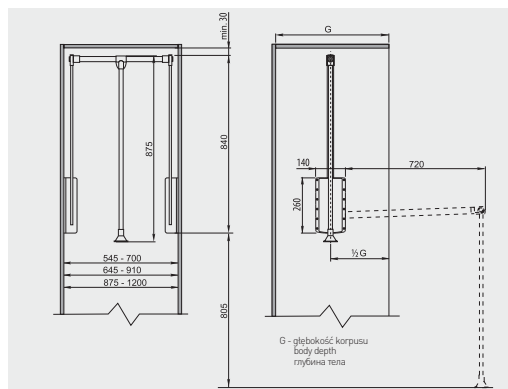

	mm	kg		
PG-ST83115-10A	875 - 1200	8	biały white белый	stal steel сталь
PG-ST6083-10A	645 - 910			
PG-ST4560-10A	545 - 700			
PG-ST83115-60	875 - 1200		antracyt anthracite антрацит	
PG-ST6083-60	645 - 910			
PG-ST4560-60	545 - 700			



Szuflada SMART na obuwie
 Pull out shoes rack SMART
 Полка SMART для обуви

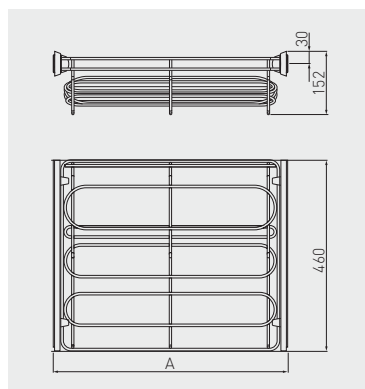

A
min./max.



W-WOBU60-BP-60	komplet bez prowadnic set without slides комплексция без направляющих	600	pełny full полное	560 – 568	szary gray серый	stal, tworzywo steel, plastic сталь, пластмасса
W-WOBU60-VE-60	na prowadnicy kulkowej H45 z funkcją cichego zamknięcia on ball bearing slide H45 with soft closing на шариковой направляющей H45 с доводчиком					
W-WOBU70-BP-60	komplet bez prowadnic set without slides комплексция без направляющих	700	pełny full полное	660 – 668	szary gray серый	stal, tworzywo steel, plastic сталь, пластмасса
W-WOBU70-VE-60	na prowadnicy kulkowej H45 z funkcją cichego zamknięcia on ball bearing slide H45 with soft closing на шариковой направляющей H45 с доводчиком					
W-WOBU80-BP-60	komplet bez prowadnic set without slides комплексция без направляющих	800	pełny full полное	760 – 768	szary gray серый	stal, tworzywo steel, plastic сталь, пластмасса
W-WOBU80-VE-60	na prowadnicy kulkowej H45 z funkcją cichego zamknięcia on ball bearing slide H45 with soft closing на шариковой направляющей H45 с доводчиком					
W-WOBU90-BP-60	komplet bez prowadnic set without slides комплексция без направляющих	900	pełny full полное	860 – 868	szary gray серый	stal, tworzywo steel, plastic сталь, пластмасса
W-WOBU90-VE-60	na prowadnicy kulkowej H45 z funkcją cichego zamknięcia on ball bearing slide H45 with soft closing на шариковой направляющей H45 с доводчиком					



W-WOBU60-BP-10	komplet bez prowadnic set without slides комплексция без направляющих	600		560 – 568		stal, tworzywo steel, plastic сталь, пластмасса
W-WOBU60-VE-10	na prowadnicy kulkowej H45 z funkcją cichego zamknięcia on ball bearing slide H45 with soft closing на шариковой направляющей H45 с доводчиком					
W-WOBU70-BP-10	komplet bez prowadnic set without slides комплексция без направляющих	700		660 – 668		
W-WOBU70-VE-10	na prowadnicy kulkowej H45 z funkcją cichego zamknięcia on ball bearing slide H45 with soft closing на шариковой направляющей H45 с доводчиком					
W-WOBU80-BP-10	komplet bez prowadnic set without slides комплексция без направляющих	800	pełny full полное	760 – 768	biały white белый	
W-WOBU80-VE-10	na prowadnicy kulkowej H45 z funkcją cichego zamknięcia on ball bearing slide H45 with soft closing на шариковой направляющей H45 с доводчиком					
W-WOBU90-BP-10	komplet bez prowadnic set without slides комплексция без направляющих	900		860 – 868		
W-WOBU90-VE-10	na prowadnicy kulkowej H45 z funkcją cichego zamknięcia on ball bearing slide H45 with soft closing на шариковой направляющей H45 с доводчиком					

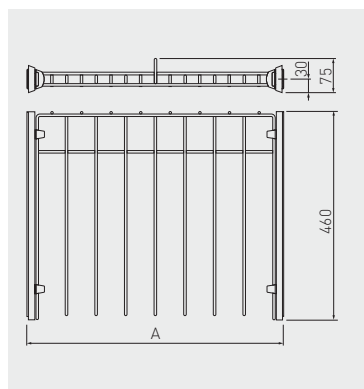

Wieszak SMART na spodnie
 SMART wardrobe trouser rack
 Вешалка SMART для брюк

A
min./max.

W-WSPD60-BP-60	komplet bez prowadnic set without slides комплексия без направляющих	600	petny full полное	szary gray серый	stal, tworzywo steel, plastic сталь, пластмасса
W-WSPD60-VE-60	na prowadnicy kulkowej H45 z funkcją cichego zamknięcia on ball bearing slide H45 with soft closing на шариковой направляющей H45 с доводчиком				
W-WSPD70-BP-60	komplet bez prowadnic set without slides комплексия без направляющих	700	petny full полное	szary gray серый	stal, tworzywo steel, plastic сталь, пластмасса
W-WSPD70-VE-60	na prowadnicy kulkowej H45 z funkcją cichego zamknięcia on ball bearing slide H45 with soft closing на шариковой направляющей H45 с доводчиком				
W-WSPD80-BP-60	komplet bez prowadnic set without slides комплексия без направляющих	800	petny full полное	szary gray серый	stal, tworzywo steel, plastic сталь, пластмасса
W-WSPD80-VE-60	na prowadnicy kulkowej H45 z funkcją cichego zamknięcia on ball bearing slide H45 with soft closing на шариковой направляющей H45 с доводчиком				
W-WSPD90-BP-60	komplet bez prowadnic set without slides комплексия без направляющих	900	petny full полное	szary gray серый	stal, tworzywo steel, plastic сталь, пластмасса
W-WSPD90-VE-60	na prowadnicy kulkowej H45 z funkcją cichego zamknięcia on ball bearing slide H45 with soft closing на шариковой направляющей H45 с доводчиком				



W-WSPD60-BP-10	komplet bez prowadnic set without slides комплексция без направляющих	600	petny full полное	560 – 568	biały white белый	stal, tworzywo steel, plastic сталь, пластмасса
W-WSPD60-VE-10	na prowadnicy kulkowej H45 z funkcją cichego zamknięcia on ball bearing slide H45 with soft closing на шариковой направляющей H45 с доводчиком					
W-WSPD70-BP-10	komplet bez prowadnic set without slides комплексция без направляющих	700	660 – 668			
W-WSPD70-VE-60	na prowadnicy kulkowej H45 z funkcją cichego zamknięcia on ball bearing slide H45 with soft closing на шариковой направляющей H45 с доводчиком					
W-WSPD80-BP-10	komplet bez prowadnic set without slides комплексция без направляющих	800	760 – 768			
W-WSPD80-VE-10	na prowadnicy kulkowej H45 z funkcją cichego zamknięcia on ball bearing slide H45 with soft closing на шариковой направляющей H45 с доводчиком					
W-WSPD90-BP-10	komplet bez prowadnic set without slides комплексция без направляющих	900	860 – 868			
W-WSPD90-VE-10	na prowadnicy kulkowej H45 z funkcją cichego zamknięcia on ball bearing slide H45 with soft closing на шариковой направляющей H45 с доводчиком					



Kosz SMART na bieliznę
 SMART wardrobe basket
 Корзина для шкафа SMART

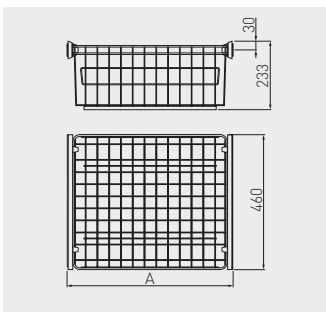





A
min./max.



W-WK060-BP-60	komplet bez prowadnic set without slides комплексия без направляющих	600	pełny full полное	szary gray серый	stal, tworzywo steel, plastic сталь, пластмасса
W-WK060-VE-60	na prowadnicy kulkowej H45 z funkcją cichego zamknięcia on ball bearing slide H45 with soft closing на шариковой направляющей H45 с доводчиком				
W-WK070-BP-60	komplet bez prowadnic set without slides комплексия без направляющих	700	pełny full полное	szary gray серый	stal, tworzywo steel, plastic сталь, пластмасса
W-WK070-VE-60	na prowadnicy kulkowej H45 z funkcją cichego zamknięcia on ball bearing slide H45 with soft closing на шариковой направляющей H45 с доводчиком				
W-WK080-BP-60	komplet bez prowadnic set without slides комплексия без направляющих	800	pełny full полное	szary gray серый	stal, tworzywo steel, plastic сталь, пластмасса
W-WK080-VE-60	na prowadnicy kulkowej H45 z funkcją cichego zamknięcia on ball bearing slide H45 with soft closing на шариковой направляющей H45 с доводчиком				
W-WK090-BP-60	komplet bez prowadnic set without slides комплексия без направляющих	900	pełny full полное	szary gray серый	stal, tworzywo steel, plastic сталь, пластмасса
W-WK090-VE-60	na prowadnicy kulkowej H45 z funkcją cichego zamknięcia on ball bearing slide H45 with soft closing на шариковой направляющей H45 с доводчиком				



		 mm	 A min./max.		
W-WK060-BP-10	komplet bez prowadnic set without slides комплексия без направляющих	600	560 – 568	pełny full полное	biały white белый
W-WK060-VE-10	na prowadnicy kulkowej H45 z funkcją cichego zamknięcia on ball bearing slide H45 with soft closing на шариковой направляющей H45 с доводчиком				
W-WK070-BP-10	komplet bez prowadnic set without slides комплексия без направляющих	700	660 – 668		
W-WK070-VE-10	na prowadnicy kulkowej H45 z funkcją cichego zamknięcia on ball bearing slide H45 with soft closing на шариковой направляющей H45 с доводчиком				
W-WK080-BP-10	komplet bez prowadnic set without slides комплексия без направляющих	800	760 – 768		
W-WK080-VE-10	na prowadnicy kulkowej H45 z funkcją cichego zamknięcia on ball bearing slide H45 with soft closing на шариковой направляющей H45 с доводчиком				
W-WK090-BP-10	komplet bez prowadnic set without slides комплексия без направляющих	900	860 – 868		
W-WK090-VE-10	na prowadnicy kulkowej H45 z funkcją cichego zamknięcia on ball bearing slide H45 with soft closing на шариковой направляющей H45 с доводчиком				



Wieszak SMART na paski i krawaty
 SMART belt and tie rack
 Вешалка для ремней и галстуков SMART

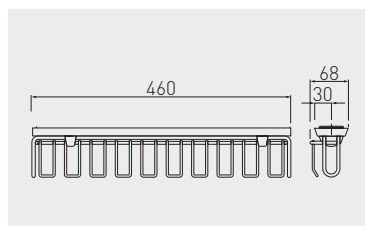

W-WKRP-BP-60	komplet bez prowadnic set without slides комплексия без направляющих	pełny full полное	szary gray серый	stal, tworzywo steel, plastic сталь, пластмасса
W-WKRP-VE-60	na prowadnicy kulkowej H45 z funkcją cichego zamknięcia on ball bearing slide H45 with soft closing на шариковой направляющей H45 с доводчиком			
W-WKRP-BP-10	komplet bez prowadnic set without slides комплексия без направляющих	biały white белый		
W-WKRP-VE-10	na prowadnicy kulkowej H45 z funkcją cichego zamknięcia on ball bearing slide H45 with soft closing на шариковой направляющей H45 с доводчиком			



Kosz dwupoziomowy na obuwie
Two tier pull out shoes rack
Двухуровневая корзина для обуви

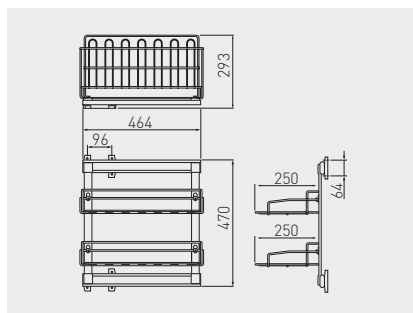

PP-20BUW0-05	lewy / prawy left / right левый / правый	niepełny partial неполное	chrom, aluminium, czarny chrome, aluminium, black хром, алюминий, чёрный	stal, aluminium, tworzywo steel, aluminium, plastic сталь, алюминий, пластмасса
--------------	--	---------------------------------	--	---



Kosz dwupoziomowy
Two tier wardrobe basket
Двухуровневая корзина

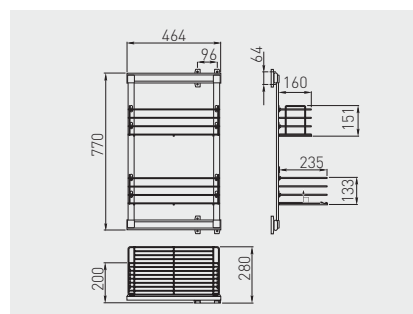

WW-2KOSZ0-05	lewy / prawy left / right левый / правый	niepełny partial неполное	chrom, aluminium, czarny chrome, aluminium, black хром, алюминий, чёрный	stal, aluminium, tworzywo steel, aluminium, plastic сталь, алюминий, пластмасса
--------------	--	---------------------------------	--	---





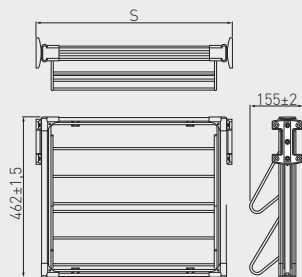

Szuflada na obuwie
Pull out shoes rack
Полка для обуви

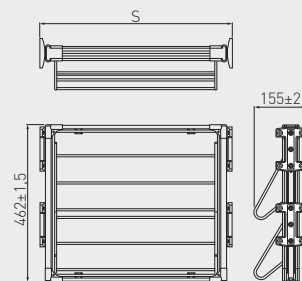

niepełny wysuw / partial extension / неполное выдвижение



pełny wysuw / full extension / полное выдвижение

			S min./max.			
PP-OB UW60-05			560 – 581	chrom chrome хром	chrom, aluminium, czarny chrome, aluminium, black хром, алюминий, чёрный	stal, aluminium, tworzywo steel, aluminium, plastic сталь, алюминий, пластмасса
PP-OB UW70-05	niepełny partial неполное		660 – 681			
PP-OB UW80-05			760 – 781			
PP-OB UW90-05			860 – 861			
PP-OB UW60-PW	pełny full полное		564 – 585			
PP-OB UW70-PW			664 – 685			
PP-OB UW80-PW			764 – 785			
PP-OB UW90-PW			864 – 885			



Kosz do szaf
 Wardrobe basket
 Корзина для шкафа

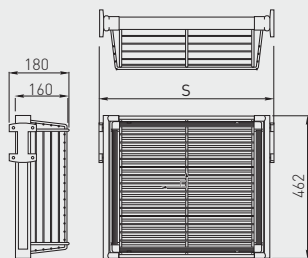

niepełny wysuw / partial extension / неполное выдвижение

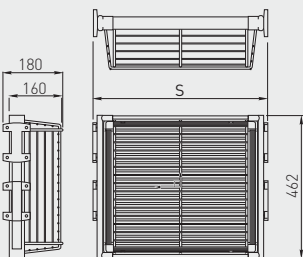

pełny wysuw / full extension / полное выдвижение

		S min./max.		
WW-KOSZ60-01	niepełny partial неполное	560 – 581	chrom, aluminium, czarny chrome, aluminium, black хром, алюминий, чёрный	stal, aluminium, tworzywo steel, aluminium, plastic сталь, алюминий, пластмасса
WW-KOSZ70-05		660 – 681		
WW-KOSZ80-05		760 – 781		
WW-KOSZ90-01		860 – 881		
WW-KOSZ60-PW	pełny full полное	564 – 585		
WW-KOSZ70-PW		664 – 685		
WW-KOSZ80-PW		764 – 785		
WW-KOSZ90-PW		864 – 885		



Wieszak na spodnie
Wardrobe trouser rack
Вешалка для брюк

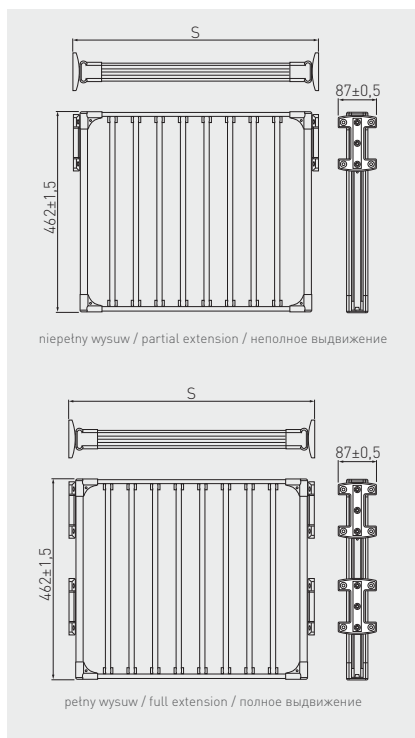







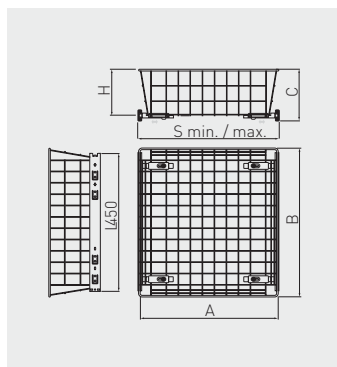





		S min./max.			
WW-WSP060-05	niepełny partial неполное	560 – 581	chrom, aluminium, czarny chrome, aluminium, black хром, алюминий, чёрный		
WW-WSP070-05		660 – 681			
WW-WSP080-05		760 – 781			
WW-WSP090-05		860 – 881			
WW-WSP060-PW	pełny full полное	564 – 585			stal, aluminium, tworzywo steel, aluminium, plastic сталь, алюминий, пластмасса
WW-WSP070-PW		664 – 685			
WW-WSP080-PW		764 – 785			
WW-WSP090-PW		864 – 885			



Kosz na prowadnicy kulkowej H35*
 Wardrobe basket on a H35 ball bearing slide*
 Корзина на шариковых направляющих H35*









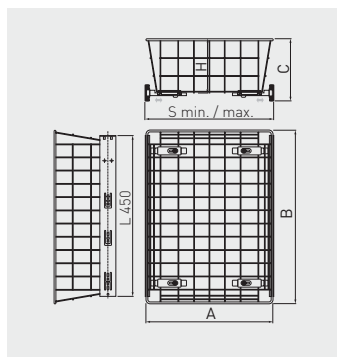





		 H mm	 A mm	 B mm	 C mm	 S min/max							
KO-SRPR100-30-10		300	100	255	485	123	260-285						
KO-SRPR100-40-10		400	100	355	485	123	360-385						
KO-SRPR100-50-10		500	100	455	485	123	460-485						
KO-SRPR100-60-10		600	100	555	485	123	560-585						
KO-SRPR150-30-10		300	150	255	485	173	260-285						
KO-SRPR150-40-10		400	150	355	485	173	360-385						
KO-SRPR150-50-10		500	150	455	485	173	460-485						
KO-SRPR150-60-10		600	150	555	485	173	560-585						
KO-SRPR200-30-10		300	200	255	485	223	260-285						
KO-SRPR200-40-10		400	200	355	485	223	360-385						
KO-SRPR200-50-10		500	200	455	485	223	460-485						
KO-SRPR200-60-10		600	200	555	485	223	560-585						
KO-SRPR150-30-0C		300	150	255	485	123	260-285				osynek galvanized гальваника	biały white белый	stal tworzywo steel plastic сталь пластмасса
KO-SRPR100-40-0C		400	100	355	485	123	360-385						
KO-SRPR100-30-0C		300	100	455	485	123	460-485						
KO-SRPR100-50-0C		500	100	555	485	123	560-585						
KO-SRPR100-60-0C		600	100	255	485	173	260-285						
KO-SRPR150-40-0C		400	150	355	485	173	360-385						
KO-SRPR150-50-0C		500	150	455	485	173	460-485						
KO-SRPR150-60-0C		600	150	555	485	173	560-585						
KO-SRPR200-30-0C		300	200	255	485	223	260-285						
KO-SRPR200-40-0C		400	200	355	485	223	360-385						
KO-SRPR200-50-0C		500	200	455	485	223	460-485						
KO-SRPR200-60-0C		600	200	555	485	223	560-585						
KO-SRPR100-30-0C		300	100	455	485	123	460-485	srebrny silver серебристый	stal tworzywo steel plastic сталь пластмасса				
KO-SRPR100-50-0C		500	100	555	485	123	560-585						
KO-SRPR150-40-0C		400	150	355	485	173	360-385						
KO-SRPR150-50-0C		500	150	455	485	173	460-485						
KO-SRPR150-60-0C		600	150	555	485	173	560-585						
KO-SRPR200-30-0C		300	200	255	485	223	260-285						
KO-SRPR200-40-0C		400	200	355	485	223	360-385						
KO-SRPR200-50-0C		500	200	455	485	223	460-485						
KO-SRPR200-60-0C		600	200	555	485	223	560-585						



Kosz na prowadnicy kulkowej H45 ze spowalniaczem
 Wardrobe basket on a H45 adjustable ball bearing slide
 Корзина на шариковых направляющих H45









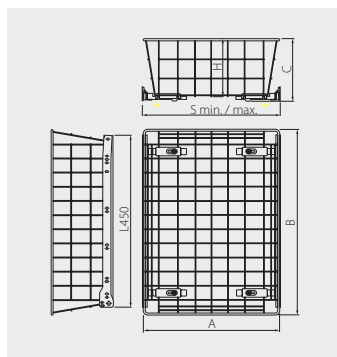

		 mm	 mm	 mm	 mm	 mm	 min./max.					
KO-SRH4550-40-OC		400	50	355	485	73	360 - 385					
KO-SRH4550-50-OC		500	50	455	485	73	460 - 485				biały white белый	
KO-SRH4550-60-OC		600	50	555	485	73	560 - 585				ocynk galvanized гальванка	stal steel сталь
KO-SRH45200-40-OC		400	200	355	485	223	360 - 385					
KO-SRH45200-50-OC		500	200	455	485	223	460 - 485				srebrny silver серебристый	
KO-SRH45200-60-OC		600	200	555	485	223	560 - 585					



Kosz na prowadnicy rolkowej L = 450*
 Wardrobe basket on a L = 450 slide*
 Корзина на роликовых направляющих L = 450*







		 H mm	 A mm	 B mm	 C mm	 S min./max.			
KO-SRPR100-30-10	300	100	255	485	115	260 - 285	оцинк galvanized гальваника	biały white белый	stal, tworzywo steel, plastic сталь, пластмасса
KO-SRPR100-40-10	400	100	355	485	115	360 - 385			
KO-SRPR100-50-10	500	100	455	485	115	460 - 485			
KO-SRPR100-60-10	600	100	555	485	115	560 - 585			
KO-SRPR150-30-10	300	150	255	485	165	260 - 285			
KO-SRPR150-40-10	400	150	355	485	165	360 - 385			
KO-SRPR150-50-10	500	150	455	485	165	460 - 485			
KO-SRPR150-60-10	600	150	555	485	165	560 - 585			
KO-SRPR200-30-10	300	200	255	485	215	260 - 285			
KO-SRPR200-40-10	400	200	355	485	215	360 - 385			
KO-SRPR200-50-10	500	200	455	485	215	460 - 485			
KO-SRPR200-60-10	600	200	555	485	215	560 - 585			
KO-SRPR150-30-0C	300	150	255	485	115	260 - 285			
KO-SRPR100-40-0C	400	100	355	485	115	360 - 385			
KO-SRPR100-30-0C	300	100	255	485	115	460 - 485			
KO-SRPR100-50-0C	500	100	455	485	115	560 - 585			
KO-SRPR100-60-0C	600	100	555	485	165	260 - 285			
KO-SRPR150-40-0C	400	150	355	485	165	360 - 385			
KO-SRPR150-50-0C	500	150	455	485	165	460 - 485			
KO-SRPR150-60-0C	600	150	555	485	165	560 - 585			
KO-SRPR200-30-0C	300	200	255	485	215	260 - 285			
KO-SRPR200-40-0C	400	200	355	485	215	360 - 385			
KO-SRPR200-50-0C	500	200	455	485	215	460 - 485			
KO-SRPR200-60-0C	600	200	555	485	215	560 - 585			
								srebrny silver серебристый	

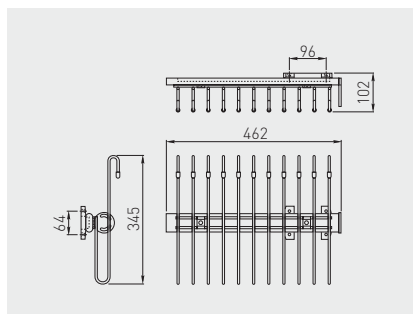





Wieszak na spodnie podwieszany
Wardrobe pull-out trouser rack
Вешалка для брюк подвесная

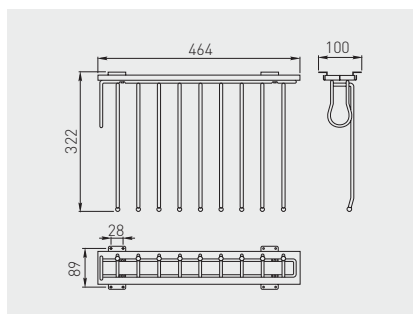

			
WW-WSP00-01	niepełny partial неполное	chrom, aluminium, czarny chrome, aluminium, black хром, алюминий, чёрный	stal, aluminium, tworzywo steel, aluminium, plastic сталь, алюминий, пластмасса





Wieszak WS na spodnie
Trouser rack WS
Вешалка WS для брюк

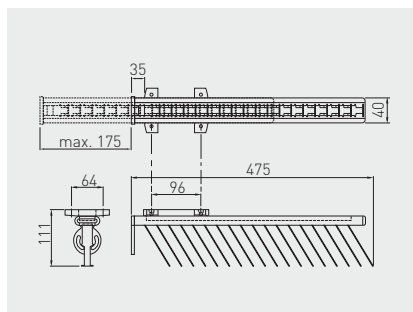

				
WW-WSP00-01	prawy right правый	niepełny partial неполное	chrom, aluminium, czarny chrome, aluminium, black хром, алюминий, чёрный	stal, aluminium, tworzywo steel, aluminium, plastic сталь, алюминий, пластмасса
WW-WSL00-01	lewy left левый			

Wieszak KRA na krawaty
 Tie hanger KRA
 Подвеска для галстуков KRA



				
WW-KRAW00-20	lewy / prawy left / right левый / правый	niepełny partial неполное	chrom, aluminium, czarny chrome, aluminium, black хром, алюминий, чёрный	stal, aluminium, tworzywo steel, aluminium, plastic сталь, алюминий, пластмасса

Wieszak KJ na krawaty
 Tie hanger KJ
 Подвеска для галстуков KJ

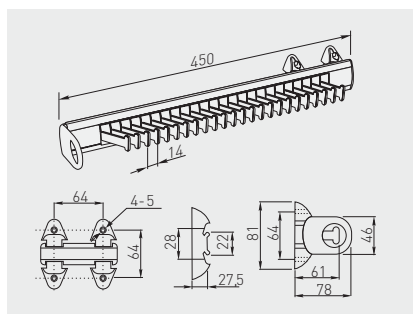

				
WW-KJ0101-01	lewy / prawy left / right левый / правый	niepełny partial неполное	aluminium, czarny aluminium, black алюминий, чёрный	stal, aluminium, tworzywo steel, aluminium, plastic сталь, алюминий, пластмасса

Wieszak KJ na paski
 Belt rack KJ
 Вешалка KJ для ремней

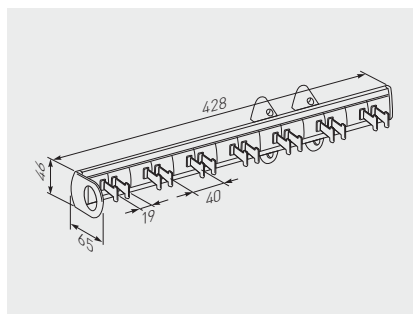



				
WW-KJ0201-01	lewy / prawy left / right левый / правый	niepetyny partial неполное	aluminium, czarny aluminium, black алюминий, чёрный	stal, aluminium, tworzywo steel, aluminium, plastic сталь, алюминий, пластмасса

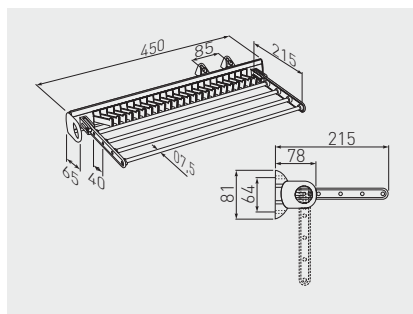

Wieszak J03 na krawaty i spodnie
 Trouser and tie hanger J03
 Вешалка J03 для брюк и галстуков



				
WW-K0AJ03-01	lewy / prawy left / right левый / правый	niepetyny partial неполное	chrom, aluminium, czarny chrome, aluminium, black хром, алюминий, чёрный	stal, aluminium, tworzywo steel, aluminium, plastic сталь, алюминий, пластмасса



Wieszak na spodnie składany
 Foldable trouser rack
 Вешалка для брюк, складная

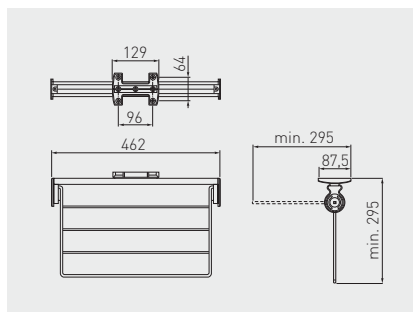

WW-SPODNO-05	lewy / prawy left / right левый / правый	niepełny partial неполное	chrom, aluminium, czarny chrome, aluminium, black хром, алюминий, чёрный	stal, aluminium, tworzywo steel, aluminium, plastic сталь, алюминий, пластмасса



Wieszak J03 na spodnie
 Trouser rack J03
 Вешалка J03 для брюк

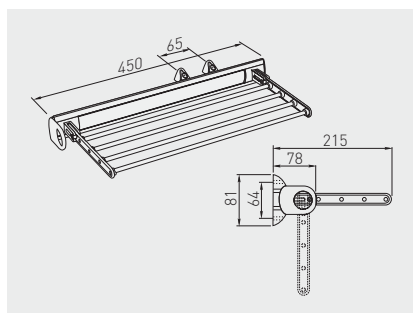

WW-K00J03-01	lewy / prawy left / right левый / правый	niepełny partial неполное	aluminium, czarny aluminium, black алюминий, чёрный	aluminium, tworzywo aluminium, plastic алюминий, пластмасса



Wieszak J04 na krawaty i spodnie
 Trouser and tie rack J04
 Вешалка J04 для брюк и галстуков

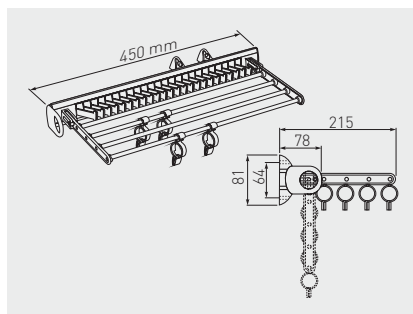

WW-K0AJ04-01	lewy / prawy left / right левый / правый	niepełny partial неполное	aluminium, czarny aluminium, black алюминий, чёрный	stal, aluminium, tworzywo steel, aluminium, plastic сталь, алюминий, пластмасса



Wieszak WU na ubrania
 Clothes hanger WU
 Вешалка WU для одежды

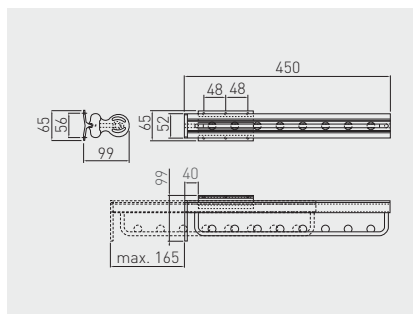

WW-WUBR00-01	niepełny partial неполное	chrom, aluminium, czarny chrome, aluminium, black хром, алюминий, чёрный	stal, aluminium, tworzywo steel, aluminium, plastic сталь, алюминий, пластмасса



Wieszak K0 na paski
Hanger for belts K0
Вешалка K0 для ремней

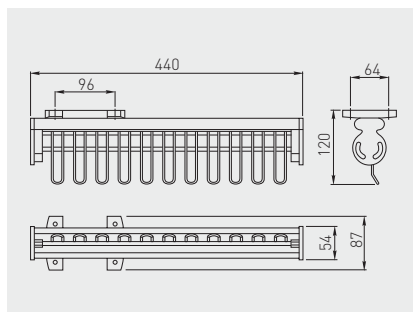

WW-PASEK0-05	lewy / prawy left / right левый / правый	niepełny partial неполное	chrom, aluminium, czarny chrome, aluminium, black хром, алюминий, чёрный	stal, aluminium, tworzywo steel, aluminium, plastic сталь, алюминий, пластмасса



Wieszak SE
Hanger SE
Вешалка SE

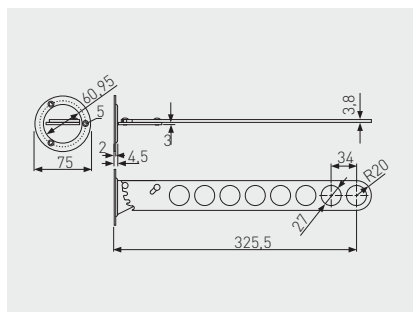





WW-SE0102-01	chrom chrome хром	stal steel сталь

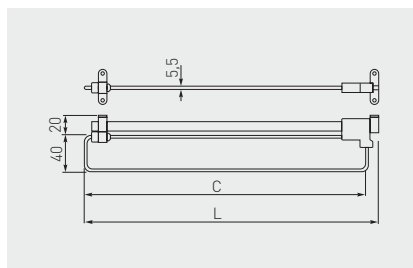







Wieszak WSL
Hanger WSL
Вешалка WSL

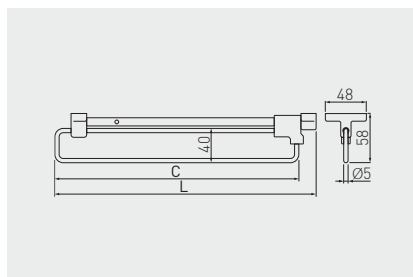

		 C mm	 L mm		
WW-WSL250-01		235	250	chrom chrome хром	stal steel сталь
WW-WSL300-01		285	300		
WW-WSL350-01		335	350		
WW-WSL400-01		385	400		
WW-WSL450-01		435	450		
WW-WSL500-01		485	500		





Wieszak WSL-B wysuwny
Retractable hanger WSL-B
Выдвижная подвеска WSL-B

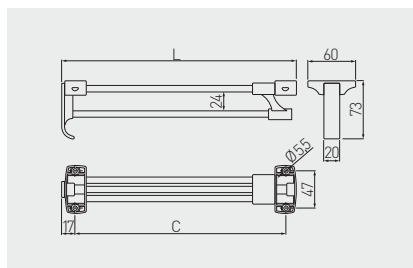

		 C mm	 L mm		
WW-WSL250-01B		235	250	chrom, czarny chrome, black хром, чёрный	stal, tworzywo steel, plastic сталь, пластмасса
WW-WSL300-01B		285	300		
WW-WSL350-01B		335	350		
WW-WSL400-01B		385	400		
WW-WSL450-01B		435	450		
WW-WSL500-01B		485	500		





Wieszak WSD wysuwny
Retractable hanger WSD
Выдвижная подвеска WSD

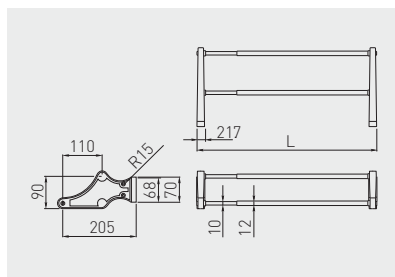

		 C mm	 L mm		
WW-WSD250-01B		220	252	chrom, czarny chrome, black хром, чёрный	stal, tworzywo steel, plastic сталь, пластмасса
WW-WSD300-01B		270	302		
WW-WSD350-01B		320	352		
WW-WSD400-01B		370	402		
WW-WSD450-01B		420	452		
WW-WSD500-01B		470	502		

Półka na obuwie
Shoe rack
Полка для обуви



		 L mm		
PP-P04570-20		415 - 700	chrom, aluminium, czarny chrome, aluminium, black хром, алюминий, чёрный	stal, aluminium, tworzywo steel, aluminium, plastic сталь, алюминий, пластмасса
PP-P80110-20		715 - 1100	chrom, czarny chrome, black хром, чёрный	stal, tworzywo steel, plastic сталь, пластмасса



Zawias do półki na obuwie
Hinge for shoe rack
Крепление для полки под обувь

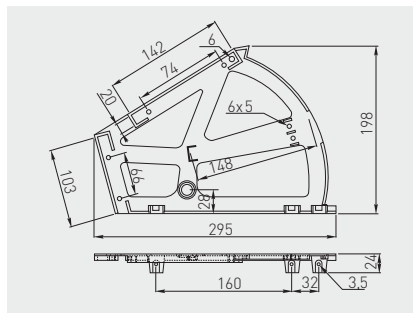

Zastosowanie dla płyty 12 mm
For 12 mm board
Крепление к плите 12 мм



WW-ZWBUT2-10	biały / white / белый	tworzywo plastic пластмасса
WW-ZWBUT2-20	czarny / black / чёрный	



Pantograf z podnośnikiem gazowym
Pull-down wardrobe rail – gas
Пантограф с газовым подъемником

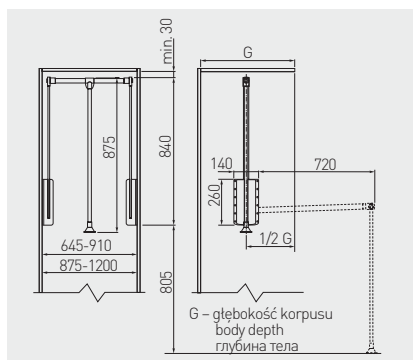





PG-GA4560-10	545 – 700	12	biały / white / белый	stal, tworzywo steel, plastic сталь, пластмасса
PG-GA6083-10	645 – 910			
PG-GA4560-20	545 – 700			
PG-GA6083-20	645 – 910			
PG-GA8311520	875 – 1200			

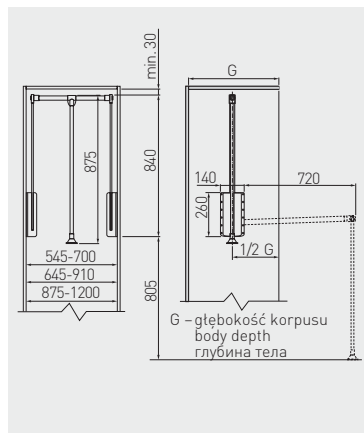

Pantograf z podnośnikiem olejowym
 Pull-down wardrobe rail – oil
 Пантограф с масляным подъемником



	 mm	 kg		
PG-AL4560-20	545 – 700	8	aluminium / aluminium / алюминий	aluminium, tworzywo aluminium, plastic алюминий, пластмасса
PG-AL6083-20	645 – 910			
PG-AL8311520	875 – 1200			
PG-ST4560-10	545 – 700		biały / white / белый	stal, tworzywo steel, plastic сталь, пластмасса
PG-ST4560-20			czarny / black / чёрный	
PG-ST6083-10	645 – 910		biały / white / белый	
PG-ST6083-20			czarny / black / чёрный	
PG-ST83115-10	875 – 1200		biały / white / белый	
PG-ST8311520		czarny / black / чёрный		



Segregator PRACTI ECO 400
 Trash bin PRACTI ECO 400
 Сегрегатор PRACTI ECO 400

NEW

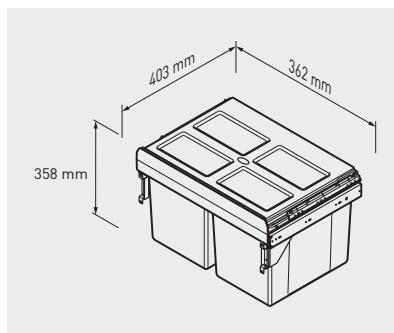

PB-45-400MF-2X16-60A

400

2 x 16 L

antracyt
 anthracite
 антрацит

tworzywo / plastic / пластмасса



Segregator PRACTI ECO 300
 Trash bin PRACTI ECO 300
 Сегрегатор PRACTI ECO 300

NEW



PB-45-0010X3-60A



PB-45-002010-60A

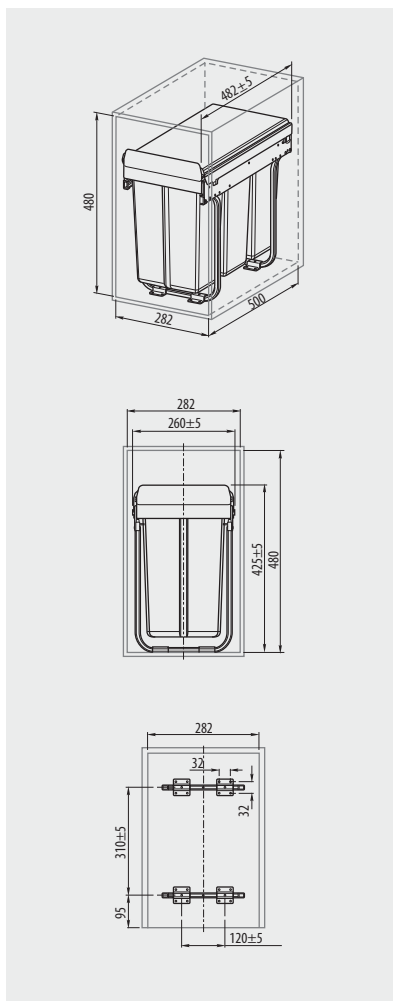

Na prowadnicy kulkowej H45 z cichym domykaniem
 On ball bearing slide H45 with soft closing
 На шариковой направляющей H45 с доводчиком

					
PB-45-0010X3-60A	300	3 x 10 L	antracyt anthracite антрацит	tworzywo / plastic / пластмасса	
PB-45-002010-60A	300	10 L, 20 L			



Segregator PRACTI ECO 400
 Trash bin PRACTI ECO 400
 Сепаратор PRACTI ECO 400

NEW







PB-45-002X20-60A

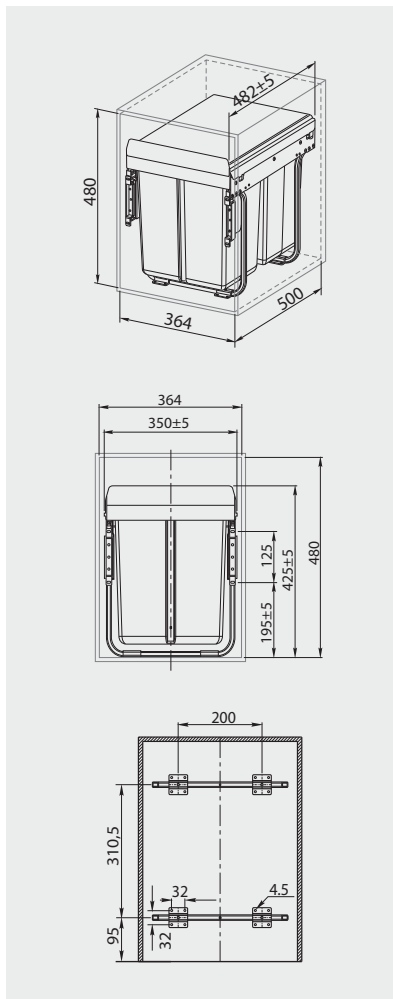

PB-45-202X10-60A

Na prowadnicy kulkowej H45 z cichym domykiem
 On ball bearing slide H45 with soft closing
 На шариковой направляющей H45 с доводчиком



					
PB-45-002X20-60A	400	2 x 20 L		antracyt anthracite антрацит	tworzywo / plastic / пластмасса
PB-45-202X10-60A	400	20 L, 2 x 10 L			



Segregator PRACTI ECO 400 z mocowaniem przednim
 Trash bin PRACTI ECO 400 with door mount bracket
 Сегрегатор PRACTI ECO 400 с передним креплением

NEW



PB-45-MF002X20-60A



PB-45-MF202X10-60A

Na prowadnicy kulkowej H45 z cichym domykiem
 On ball bearing slide H45 with soft closing
 На шариковой направляющей H45 с доводчиком

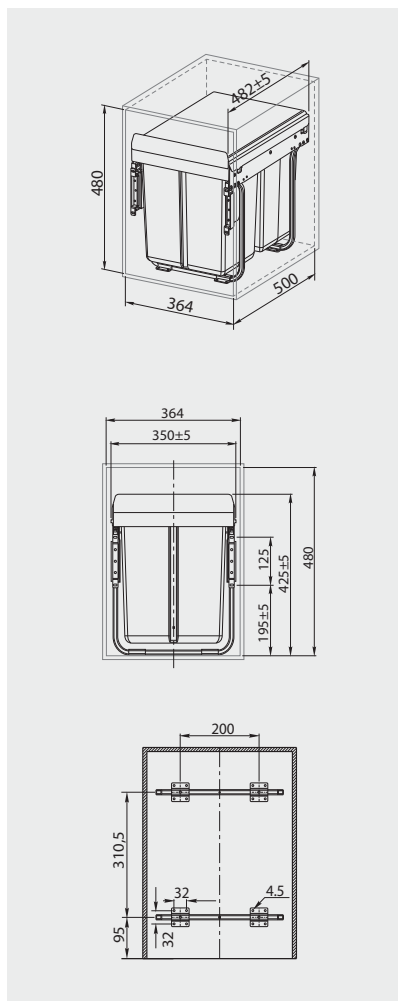

PB-45-MF002X20-60A	400	2 x 20 L	antracyt anthracite антрацит	tworzywo / plastic / пластмасса
PB-45-MF202X10-60A		20 L, 2 x 10 L		



Segregator PRACTI ECO 450, niski
 Trash bin PRACTI ECO 450, low
 Сегрегатор PRACTI ECO 450, низкий

NEW



PB-45-002X15-60A

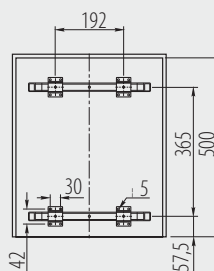
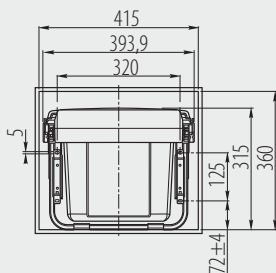
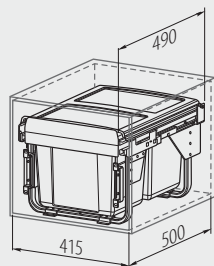

Na prowadnicy z cichym domykiem
 On slide with soft closing
 На направляющей с доводчиком



PB-45-002X15-60A	450	2 x 15 L	antracyt anthracite антрацит	tworzywo / plastic / пластмасса
------------------	-----	----------	------------------------------------	---------------------------------



Segregator PRACTI ECO 450 niski z mocowaniem przednim
 Trash bin PRACTI ECO 450 low with door mount bracket
 Сегрегатор PRACTI ECO 450 низкий с передним креплением

NEW



PB-45-MF2X15-60A

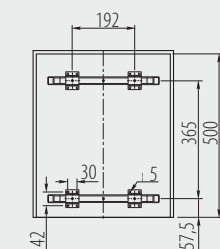
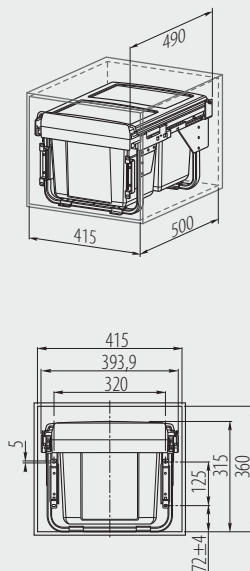

Na prowadnicy z cichym domykiem
 On slide with soft closing
 На направляющей с доводчиком



PB-45-MF2X15-60A	450	2 x 15 L	antracyt anthracite антрацит	tworzywo / plastic / пластмасса
------------------	-----	----------	------------------------------------	---------------------------------



Segregator PRACTI ECO 450 wysoki
 Trash bin PRACTI ECO 450 high
 Сегрегатор PRACTI ECO 450 высокий

NEW





PB-45-450-2X20-60A

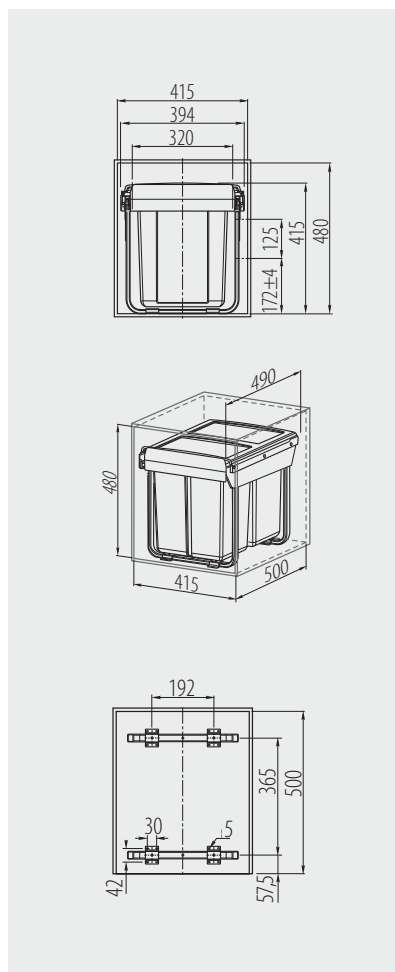

PB-45-0202X10-60A



Na prowadnicy z cichym domykiem
 On slide with soft closing
 На направляющей с доводчиком

				
PB-45-450-2X20-60A	450	2 x 20 L	antracyt anthracite антрацит	tworzywo / plastic / пластмасса
PB-45-0202X10-60A		20 L, 2 x 10 L		



Segregator PRACTI ECO 450 wysoki z mocowaniem przednim
 Trash bin PRACTI ECO 450 high with door mount bracket
 Сегрегатор PRACTI ECO 450 высокий с передним креплением

NEW







PB-45-450MF202X10-60A

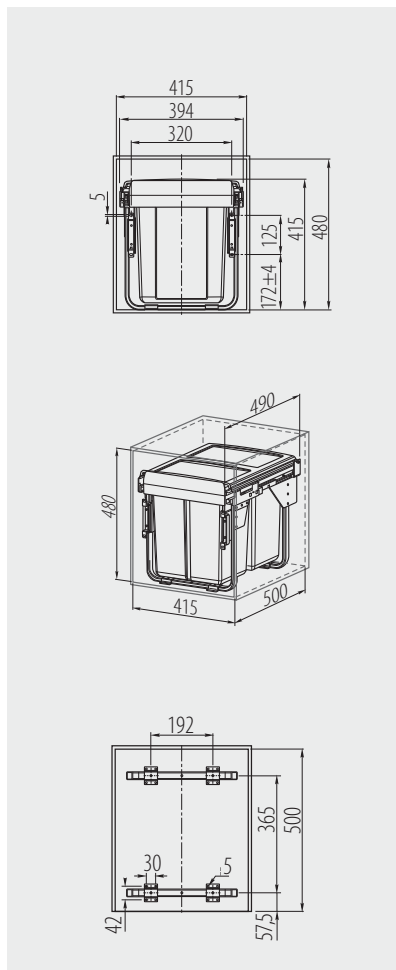

PB-45-MF2X20-60A



Na prowadnicy z cichym domykiem
 On slide with soft closing
 На направляющей с доводчиком

					
PB-45-450MF202X10-60A		450	20 L, 2 x 10 L	antracyt anthracite антрацит	tworzywo / plastic / пластмасса
PB-45-MF2X20-60A			2 x 20 L		



Segregator PRACTI ECO 600
 Trash bin PRACTI ECO 600
 Сегрегатор PRACTI ECO 600

NEW

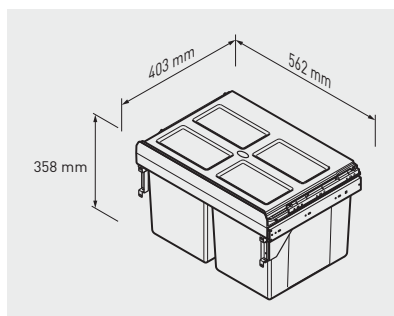

PB-45-600MF-2X27-60A

600

2 x 27 L

antracyt
 anthracite
 антрацит

tworzywo / plastic / пластмасса



Segregator PRACTI ECO 600 wysoki z mocowaniem przednim
 Trash bin PRACTI ECO 600 high with door mount bracket
 Сегрегатор PRACTI ECO 600 высокий с передним креплением

NEW







PB-45-MF342X17-60A

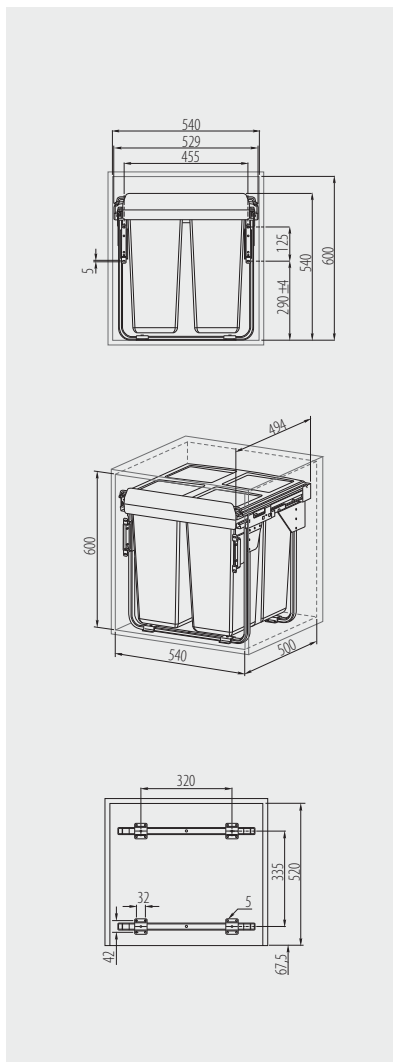

PB-45-MF2X34-60A



Na prowadnicy z cichym domykiem
 On slide with soft closing
 На направляющей с доводчиком

	 mm			
PB-45-MF342X17-60A	600	34 L, 2 x 17 L	antracyt anthracite антрацит	tworzywo / plastic / пластмасса
PB-45-MF2X34-60A		2 x 34 L		



Kosz QUADRA
Trash bin QUADRA
Мусорная корзина QUADRA

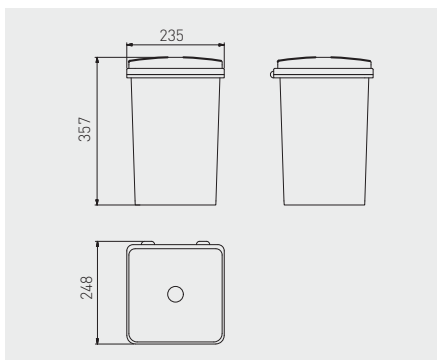

PB-91014100



13 L



szary / gray / серый



tworzywo / plastic / пластмасса



Kosz CIRCA
Trash bin CIRCA
Мусорная корзина CIRCA

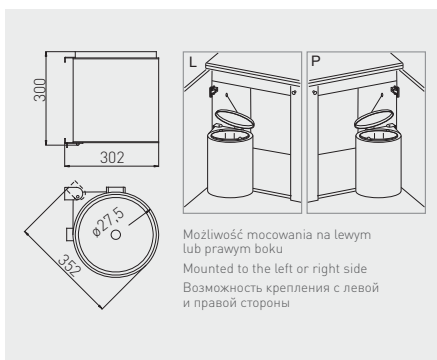

PB-91024160V



11 L



szary / gray / серый



tworzywo / plastic / пластмасса



Kosz ALTOLINO
 Trash bin ALTOLINO
 Мусорная корзина ALTOLINO



Możliwość mocowania na lewym lub prawym boku
 Can be mounted to the left or right side
 Возможность крепления с левой и правой стороны

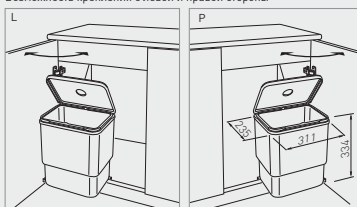

Wymiary montażowe / Mounting dimensions / Монтажные размеры

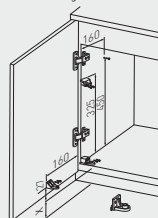

X – odległość od podłogi do górnej krawędzi wieńca
 X – distance from the floor to bottom of cabinet
 X – расстояние между полом и плоскостью дна шкафа

Sposób montażu / Instruction of installation / Способ монтажа

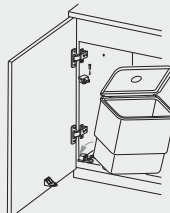

Podwieszenie pokrywy / Suspension cover / Крепление крышки

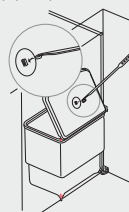

PB-90114100

16 L

szary / gray / серый

tworzywo / plastic / пластмасса



Segregator TIRA 350 plus
 Trash bin TIRA 350 plus
 Сегрегатор TIRA 350 plus

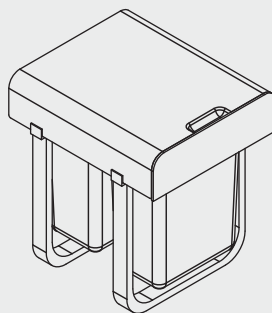
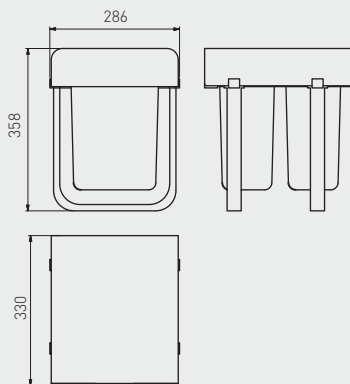

PB-90144100PCT

od 350 / from 350 / от 350

2 x 8 L

szary / gray / серый

tworzywo / plastic / пластмасса



Segregator FORZA 400 plus
 Trash bin FORZA 400 plus
 Серператор FORZA 400 plus

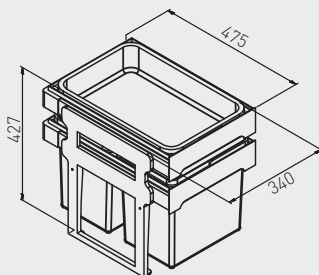
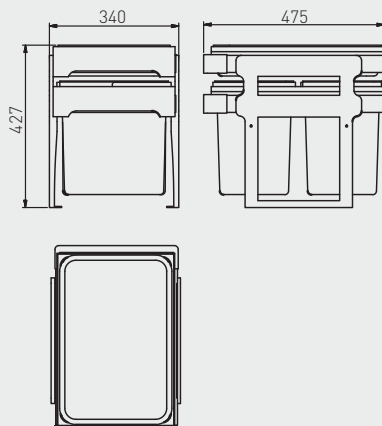

PB-90934100PCT

od 400 / from 400 / от 400

2 x 16 L

szary / gray / серый

tworzywo / plastic / пластмасса



Segregator MULTINO Trash bin MULTINO Сегрегатор MULTINO

Przeznaczone do szuflad Modern Box
For Modern Box drawers
Только для ящиков Modern Box



PB-91114100B5



PB-91104100B5



PB-91634100B5

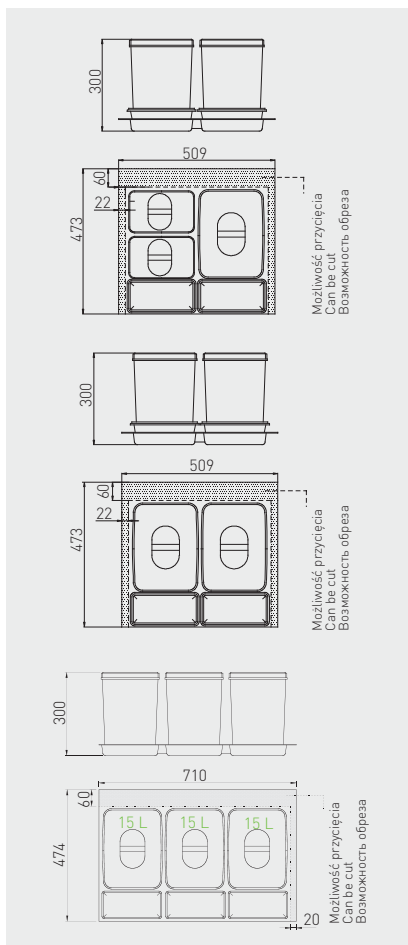

PB-91104100B5	600	2 x 15 L, 2 brytfanki / 2 tray storage spaces / наполнители	szary gray серый	tworzywo plastic пластмасса
PB-91114100B5		1 x 15 L, 2 x 7 L, 2 brytfanki / 2 tray storage spaces / наполнители		
PB-91634100B5V	800	3 x 15 L, 3 brytfanki / 3 tray storage spaces / наполнители	szary gray серый	tworzywo plastic пластмасса
PB-91644100B5V		2 x 15L, 2 x 7 L, 3 brytfanki / 3 tray storage spaces / наполнители		
PB-91164100B5	900	3 x 15 L, 3 brytfanki / 3 tray storage spaces / наполнители	szary gray серый	tworzywo plastic пластмасса
PB-91174100B5		2 x 15 L, 2 x 7, 3 brytfanki / 3 tray storage spaces / наполнители		



Segregator MULTINO Trash bin MULTINO Сегрегатор MULTINO

Przeznaczone do szuflad Modern Box
For Modern Box drawers
Только для ящиков Modern Box



PB-91644100B5



PB-91174100B5



PB-91164100B5

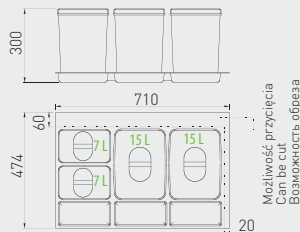

Segregator MULTINO 800 (bez przycinania) jest dopasowany do szuflady MODERN BOX NL = 500 zamontowanej w korpusie LW = 764*

Without modifications, the MULTINO 800 trash bin is designed to fit MODERN BOX NL = 500 drawer, mounted in a cabinet LW = 764*

Сегрегатор MULTINO 800 (без обреза) подходит к системе ящиков MODERN BOX NL = 500, замонтированной в корпусе LW = 746*

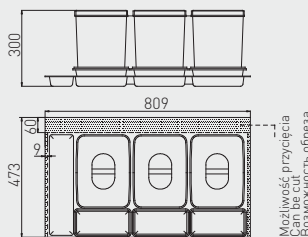
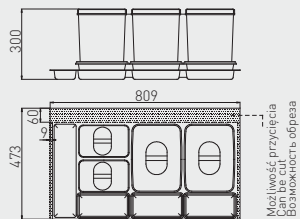

Corner standard
 Corner standard
 Выдвижная корзина, стандарт

Cichy domyk, mocowanie do frontu
 Soft closing, door mounting bracket
 Доводчик, крепление к фасаду

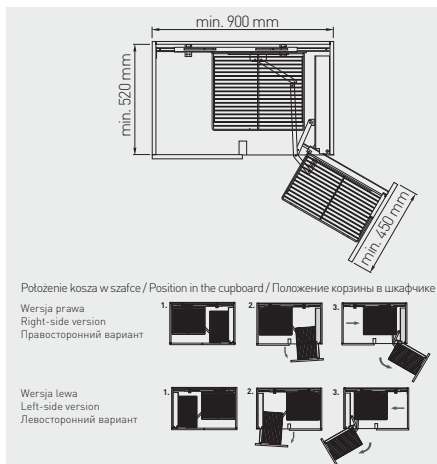
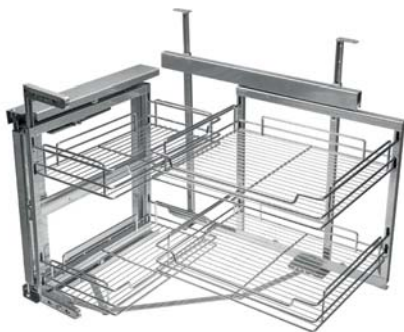

KO-UMC4840SC	lewy / prawy left / right левый / правый	40	lakier, chrom lacquer, chrome лак, хром	chrom, srebrny chrome, silver хром, серебристый	stal steel сталь
--------------	--	----	---	---	------------------------



Corner DUO
 Corner DUO
 Корзина DUO

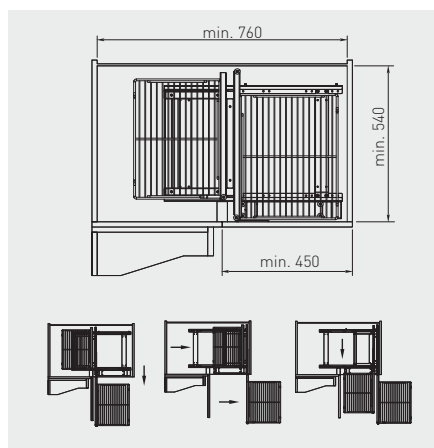







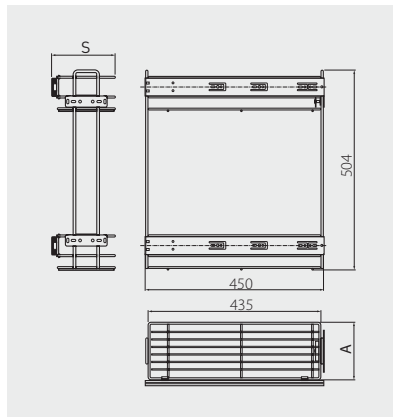

KO-UMC4645SC	lewy / prawy left / right левый / правый	40	lakier, chrom lacquer, chrome лак, хром	chrom, srebrny chrome, silver хром, серебристый	stal steel сталь
--------------	--	----	---	---	------------------------



Cargo boczne na prowadnicy kulkowej H45 ze spowalniaczem
 Side cargo on a H45 ball bearing slide with soft closing
 Выдвижная корзина с боковым креплением на шариковых направляющих H45 с механизмом плавного закрытия









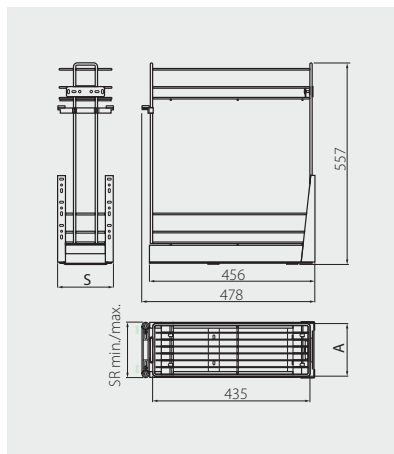

			 mm	 mm	 mm				
KO-1502B0-CR			150	95	110	ocynk galvanized гальваника	chrom chrome хром	stal steel сталь	
KO-2002B0-CR			200	145	160				
KO-3002B0-CR			300	245	260				
KO-1502B0-10*	lewy / prawy left / right левый / правый		150	95	110				biały white белый
KO-2002B0-10*			200	145	160				
KO-3002B0-10*			300	245	260				
KO-1502B0-SR			150	95	110				srebrny silver серебристый
KO-2002B0-SR			200	145	160				
KO-3002B0-SR			300	245	260				



* Produkt dostępny na indywidualne zamówienie / Available for special orders / Товар доступен под заказ

Cargo dolne na prowadnicy kulkowej H45 ze spowalniczem
 CARGO LOWER ball bearing slide H45 with soft close system
 Выдвижная корзина для нижних шкафов на шариковых направляющих H45 с механизмом плавного закрытия



	 mm	 mm	 mm			
KO-1502MD-CR	150	95	104	осцил galvanized гальваника	chrom chrome хром	stal steel сталь
KO-2002MD-CR	200	145	154			
KO-3002MD-CR	300	245	254			
KO-4002MD-CR	400	345	345			
KO-5002MD-CR*	500	445	445			
KO-6002MD-CR*	600	545	554			
KO-1502MD-SR	150	95	104		srebrny silver серебристый	
KO-2002MD-SR	200	145	154			
KO-3002MD-SR	300	245	254			
KO-4002MD-SR	400	345	345			
KO-5002MD-SR*	500	445	445			
KO-6002MD-SR*	600	545	554			









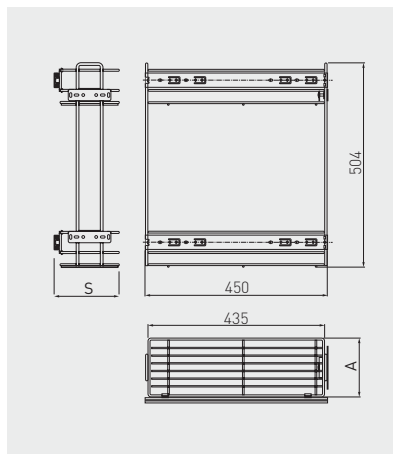

* Produkt dostępny na indywidualne zamówienie / Available for special orders / Товар доступен под заказ

Cargo boczne na prowadnicy kulkowej H35

Side cargo on a H35 ball bearing slide

Выдвижная корзина с боковым креплением на шариковых направляющих H35



			 mm	 mm	 mm					
KO-CMB150-PW-01			150	95	110	ocynk galvanized гальваника	chrom chrome хром	stal steel сталь		
KO-CMB200-PW-01*			200	145	160					
KO-CMB300-PW-01*			300	245	260					
KO-CMB150-PW-10	lewy / prawy left / right левый / правый		150	95	110		ocynk galvanized гальваника		biały white белый	
KO-CMB200-PW-10*			200	145	160					
KO-CMB300-PW-10*			300	245	260					
KO-CMB150-PW-OC				150	95				110	srebrny silver серебристый
KO-CMB200-PW-OC				200	145				160	
KO-CMB300-PW-OC*				300	245				260	



* Produkt dostępny na indywidualne zamówienie / Available for special orders / Товар доступен под заказ

Ociekarka dwupoziomowa do montażu
Two tier dish drying rack
Двухуровневая сушилка для посуды (монтаж)



OC-A0150-06		
OC-A0160-06	stal szcztokowana brushed steel шлифованная сталь	stal nierdzewna stainless steel нержавеющая сталь
OC-A0170-06		
OC-A0180-06		
OC-A0190-06		

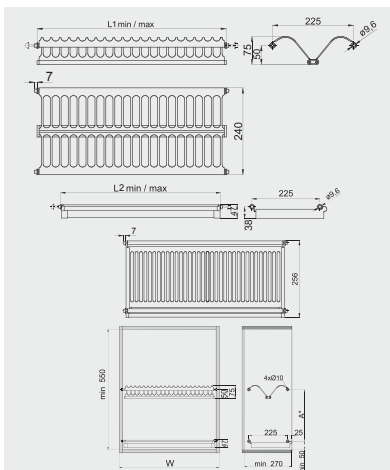

A* wymiar zależy od wysokości szafki i planowanego zagospodarowania (np. A = 275mm)
A* dimension depends on the height of the cabinet and space planning (e.g. A = 275mm)
A* размер зависит от высоты шкафа и планировки внутреннего пространства
(напр. A = 275mm)

L min./max.	W min./max.
430/480	450/475
530/580	550/575
630/680	650/675
730/780	750/775
830/880	850/875

Ociekarka jednopoziomowa do montażu
Dish drying rack
Сушилка для посуды (монтаж)





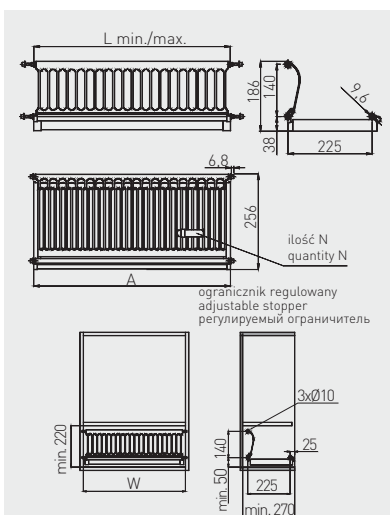



OC-A0660-06	stal szcztokowana brushed steel шлифованная сталь	stal nierdzewna stainless steel нержавеющая сталь
OC-A0680-06		

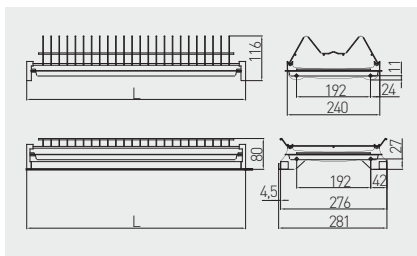

L min./max.	L min./max.	N
530/580	550/575	6
730/780	750/775	8

Ociekarka dwupoziomowa do montażu
 Two tier dish drying rack
 Двухуровневая сушилка для посуды (встраиваемая)



		 mm		
OC-2PV340-01	do płyty 16 mm for 16 mm board для поверхности 16 мм	368	chrom chrome хром	stal nierdzewna, tworzywo stainless steel, plastic нержавеющая сталь, пластмасса
OC-2PV350-01		468		
OC-2PV360-01		568		
OC-2PV370-01		668		
OC-2PV380-01		768		
OC-2PV390-01	868			
OC-2PV340-01-18	do płyty 18 mm for 18 mm board для поверхности 18 мм	364		
OC-2PV350-01-18		464		
OC-2PV360-01-18		564		
OC-2PV370-01-18		664		
OC-2PV380-01-18		764		
OC-2PV390-01-18		864		



Ociekarka dwupoziomowa A04, wolnostojąca
Two tier dish drying rack A04
Сушилка для посуды настольная A04, двухуровневая

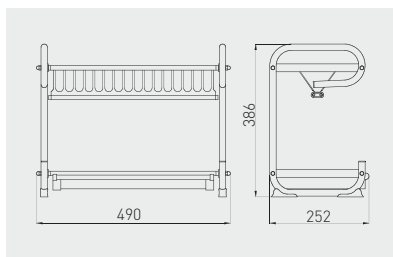

OC-A0450-06



stal szczotkowana
brushed steel
шлифованная сталь



stal nierdzewna
stainless steel
нержавеющая сталь



Ociekarka dwupoziomowa A03, wolnostojąca
Two tier dish drying rack A03
Сушилка для посуды настольная A03, двухуровневая

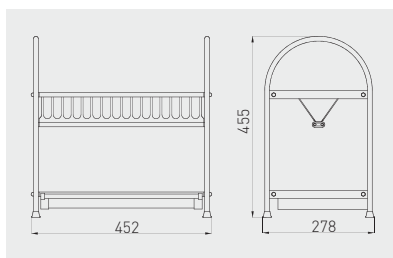

OC-A0350K-06



stal szczotkowana
brushed steel
шлифованная сталь



stal nierdzewna
stainless steel
нержавеющая сталь



Ociekarka dwupoziomowa z organizerem, wolnostojąca
 Two tier dish drying rack with organizer
 Сушилка для посуды и столовых приборов настольная, двухуровневая

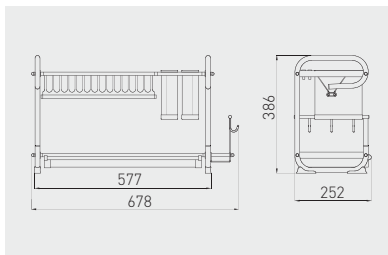

OC-A0460D-06



stal szczotkowana
 brushed steel
 шлифованная сталь



stal nierdzewna
 stainless steel
 нержавеющая сталь



Ociekarka zwijana
 Roll-up drying rack
 Складная сушилка

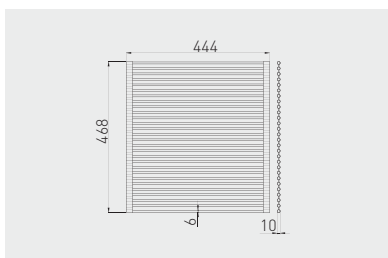

OC-E0707D-CZ



stal szczotkowana, czarny
 brushed steel, black
 шлифованная сталь, чёрный



stal nierdzewna
 stainless steel
 нержавеющая сталь



Wkład CUSTOMI A regulowany
Adjustable cutlery organizer CUSTOMI A
Вкладыш CUSTOMI A с возможностью регулировки

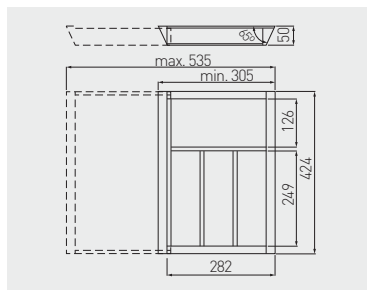

Do szuflad Modern Box i Axis PRO L = 450
For Modern Box or Axis PRO L = 450 mm
Подходит для ящиков Modern Box/Axis PRO L = 450 mm

Maksymalny wysuw = 535 mm
Maximum extension = 535 mm
Максимальное выдвижение = 535 mm

				
W-CUSTOMI-60L450	424 x 305	lakier bezbarwny matowy clearcoat matt surface лак матовый бесцветный	buk beech бук	drewno buk beech wood дерево бука



Wkład CUSTOMI BIS A regulowany
Adjustable cutlery organizer CUSTOMI BIS A
Вкладыш CUSTOMI BIS A с возможностью регулировки

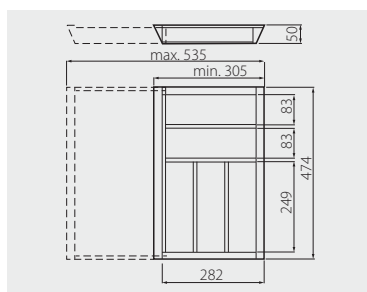

Do szuflad Modern Box i Axis PRO L = 500
For Modern Box or Axis PRO L = 500 mm
Подходит для ящиков Modern Box/Axis PRO L = 500 mm

Maksymalny wysuw = 535 mm
Maximum extension = 535 mm
Максимальное выдвижение = 535 mm

				
W-CUSTOMI-60L500	474 x 305	lakier bezbarwny matowy clearcoat matt surface лак матовый бесцветный	buk beech бук	drewno buk beech wood дерево бука



Wkład CUSTOMI B regulowany
Adjustable cutlery organizer CUSTOMI B
Вкладыш CUSTOMI B с возможностью регулировки



Do szuflad Modern Box i Axis PRO L = 450
For Modern Box or Axis PRO L = 450 mm
Подходит для ящиков Modern Box/Axis PRO L = 450 mm

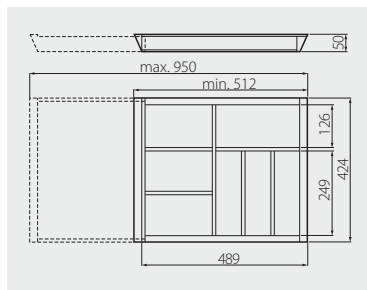

Maksymalny wysuw = 950 mm
Maximum extension = 950 mm
Максимальное выдвижение = 950 mm

				
W-CUSTOMI-80L450	512 x 424	lakier bezbarwny matowy clearcoat matt surface лак матовый бесцветный	buk beech бук	drewno buk beech wood дерево бука





Wkład CUSTOMI BIS B regulowany
Adjustable cutlery organizer CUSTOMI BIS B
Вкладыш CUSTOMI BIS B с возможностью регулировки

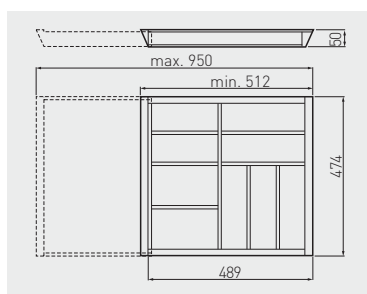

Do szuflad Modern Box i Axis PRO L = 500
For Modern Box or Axis PRO L = 500 mm
Подходит для ящиков Modern Box/Axis PRO L = 500 mm



Maksymalny wysuw = 950 mm
Maximum extension = 950 mm
Максимальное выдвижение = 950 mm

				
W-CUSTOMI-80L500	512 x 474	lakier bezbarwny matowy clearcoat matt surface лак матовый бесцветный	buk beech бук	drewno buk beech wood дерево бука



Wkład INSERTI A
Cutlery organizer INSERTI A
Универсальный вкладыш INSERTI A

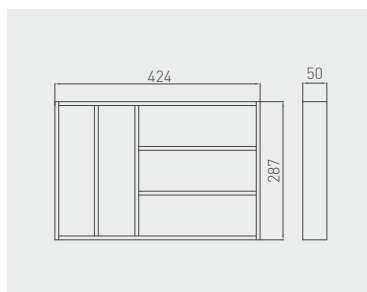

Do szuflad Modern Box i Axis PRO L = 450
For Modern Box or Axis PRO L = 450 mm
Подходит для ящиков Modern Box/Axis PRO L = 450 мм

				
W-INSERTI-L450	424 x 287	lakier bezbarwny matowy clearcoat matt surface лак матовый бесцветный	buk beech бук	drewno buk beech wood дерево бука





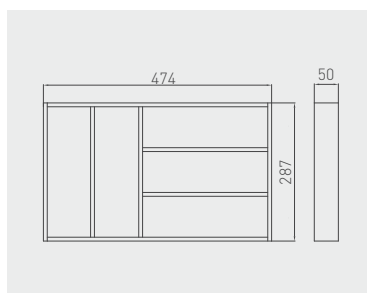
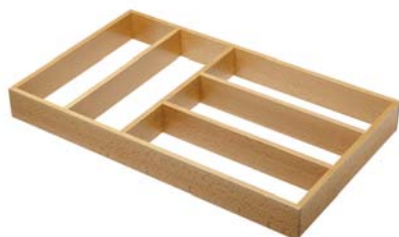

PRO

Wkład INSERTI B
Cutlery organizer INSERTI B
Универсальный вкладыш INSERTI B



Do szuflad Modern Box i Axis PRO L = 500
For Modern Box or Axis PRO L = 500 mm
Подходит для ящиков Modern Box/Axis PRO L = 500 мм

				
W-INSERTI-L500	474 x 287	lakier bezbarwny matowy clearcoat matt surface лак матовый бесцветный	buk beech бук	drewno buk beech wood дерево бука



Mata antypoślizgowa do szuflad
 Anti-slip mat for drawers
 Противоскользящий коврик для ящиков



	 mm		
MA-MATA-0-00	1500 x 470	przeźroczysty transparent прозрачный	tworzywo plastic пластмасса



Półka pod klawiaturę z prowadnicą kulkową 27 mm
 Keyboard shelf with 27 mm drawer slide
 Полка для клавиатуры с шариковой направляющей 27 мм

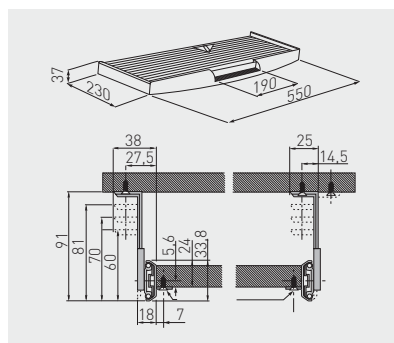

		
PU-KEY027-20	czarny / black / чёрный	tworzywo plastic пластмасса
PU-KEY027-60	szary / gray / серый	



Półka pod klawiaturę z podkładką na myszkę
 Keyboard shelf with mouse pad
 Полка для клавиатуры с подставкой для мыши

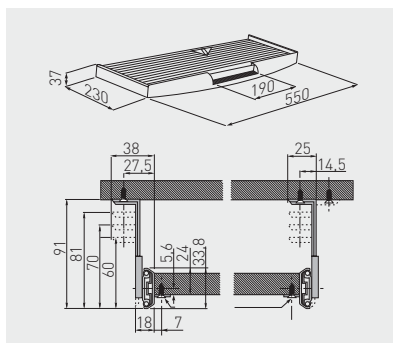

PU-KEYM27-20	czarny / black / чёрны	tworzywo plastic пластмасса
PU-KEYM27-60	szary / gray / серый	



Wózek pod komputer
 Computer trolley
 Передвижная подставка под компьютер

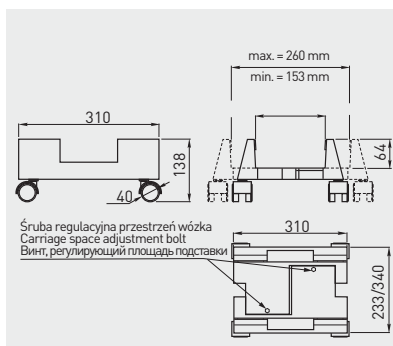
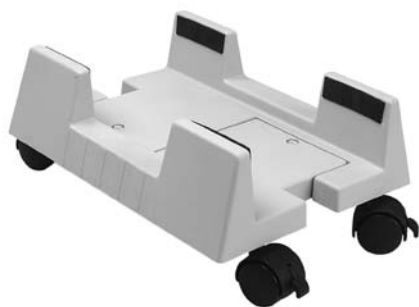

PU-PKO-00-20	czarny / black / чёрны	tworzywo plastic пластмасса
PU-PKO-00-60	szary / gray / серый	



Hub – 4 porty USB
 Hub – 4 USB ports
 Удлинитель на 4 входа USB

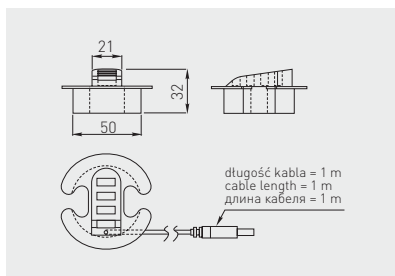

NB-USB-4X-20	czarny / black / чёрный	tworzywo plastic пластмасса
NB-USB-4X-60	srebrny / silver / серебряный	



Przepust MERIDA 80
 Desk cable outlet MERIDA 80
 Пропуск для кабеля MERIDA 80

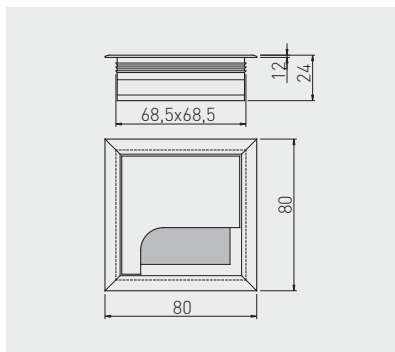

LB-K80X80-05	80 x 80	aluminium / aluminium / алюминий	aluminium aluminium алюминий
LB-K80X80-20		czarny / black / чёрный	



Przepust MERIDA 100
 Desk cable outlet MERIDA 100
 Пропуск для кабеля MERIDA 100

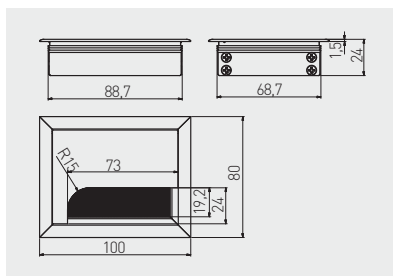



			
LB-K80X100-05	80 x 100 mm	aluminium / aluminium / алюминий	aluminium aluminium алюминий
LB-K80X100-20		czarny / black / чёрный	

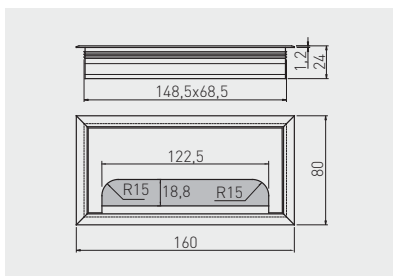

Przepust MERIDA 160
 Desk cable outlet MERIDA 160
 Пропуск для кабеля MERIDA 160





			
LB-80X160-05	80 x 160 mm	aluminium / aluminium / алюминий	aluminium aluminium алюминий
LB-80X160-20		czarny / black / чёрный	

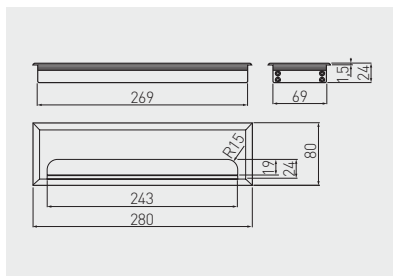

Przepust MERIDA 280
 Desk cable outlet MERIDA 280
 Пропуск для кабеля MERIDA 280



			
LB-80X280-05	80 x 280	aluminium / aluminium / алюминий	aluminium
LB-80X280-20		czarny / black / чёрный	aluminium aluminium алюминий



Przepust MERIDA 500
 Desk cable outlet MERIDA 500
 Пропуск для кабеля MERIDA 500

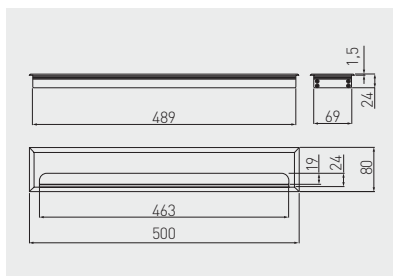

			
LB-80X500-05	80 x 500	aluminium / aluminium / алюминий	aluminium
LB-80X500-20		czarny / black / чёрный	aluminium aluminium алюминий



Przepust PLF
 Desk cable grommet PLF
 Пропуск для кабеля PLF

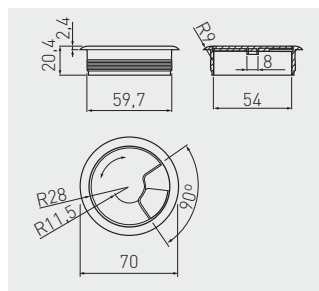

PM-PLFI60-02	satyna / satin / сатин	tworzywo plastic пластмасса
PM-PLFI60-05	aluminium / aluminium / алюминий	
PM-PLFI60-10	biały / white / белый	
PM-PLFI60-20	czarny / black / чёрный	
PM-PLFI60-30	szary / gray / серый	
PM-PLFI60-41	olcha / alder / ольха	
PM-PLFI60-42	grusza / pear / груша	
PM-PLFI60-43	jasny brąz / light brown / светло-коричневый	
PM-PLFI60-44	buk / beech / бук	
PM-PLFI60-45	orzech / walnut / цвет орех	
PM-PLFI60-46	rustikal / rustikal / рустикал	
PM-PLFI60-47	buk / beech / бук	
PM-PLFI60-48	mahoń / mahogany / красное дерево	
PM-PLFI60-49	klon / maple / клен	
PM-PLFI60-50	beż / beige / бежевый	
PM-PLFI60-51	kalwados / calvados / кальвадос	
PM-PLFI60-52	wiśnia / cherry / вишня	
PM-PLFI60-58	wenge / venge / венге	



Przepust LBF
Desk cable grommet LBF
Пропуск для кабеля LBF

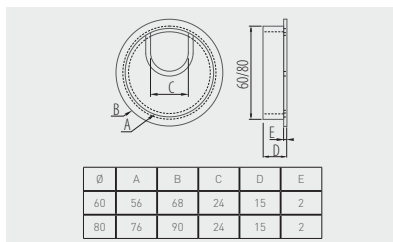

PM-LBFI60-01		60	chrom / chrome / хром	ZnAl
PM-LBFI60-02			satyna / satin / сатин	
PM-LBFI60-05			aluminium / aluminium / алюминий	
PM-LBFI60-06			stal szorstkowana / brushed steel / шлифованная сталь	
PM-LBFI80-01		80	chrom / chrome / хром	
PM-LBFI80-02			satyna / satin / сатин	
PM-LBFI80-05			aluminium / aluminium / алюминий	
PM-LBFI80-06			stal szorstkowana / brushed steel / шлифованная сталь	



Zamek K-138
Lock K-138
Замок K-138

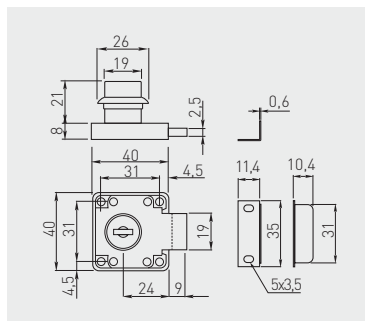

ZZ-KM-138-01		chrom / chrome / хром	ZnAl, stal / ZnAl, steel / ZnAl, сталь

Zamek Z-138 z kluczem tamany
 Lock Z-138 with folding key
 Замок Z-138 со складным ключом

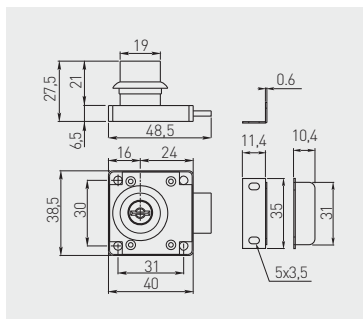

ZZ-ZN-138-01



chrom / chrome / хром



ZnAl, stal / ZnAl, steel / ZnAl, сталь

Zamek C-138 z kluczem cyfrowym
 Lock C-138 with key
 Замок C-138 с цифровым ключом

Kompatybilny z kluczem MASTER
 Compatible with MASTER key
 Подходит для ключа MASTER

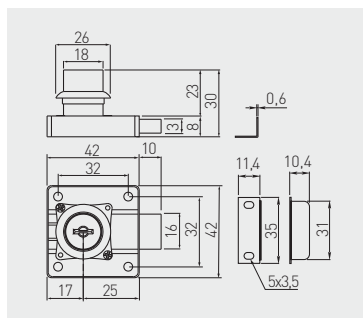

ZZ-CF-138-01



chrom / chrome / хром



ZnAl, stal / ZnAl, steel / ZnAl, сталь

Klucz MASTER do zamka C-138
 MASTER key for C-138 lock
 Ключ MASTER к замку C-138



ZZ-KLMASTER



chrom / chrome / хром



ZnAl, stal / ZnAl, steel / ZnAl, сталь

Zamek Z-338 zatraskowy
 Square lock Z-338
 Замок Z-338 с защёлкой

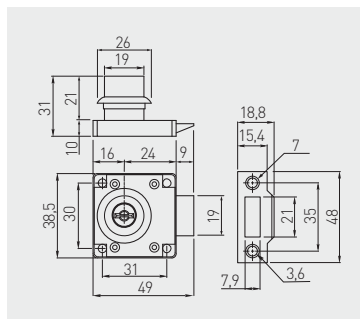

ZZ-ZN-338-01



chrom / chrome / хром



ZnAl, stal / ZnAl, steel / ZnAl, сталь



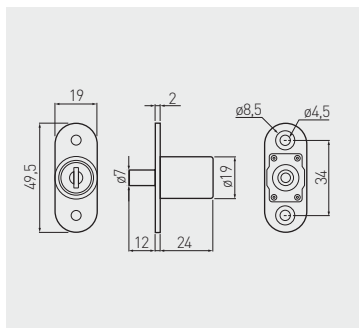

Zamek B-105 bolcowy
 Pin lock B-105
 Замок B-105 кнопочный

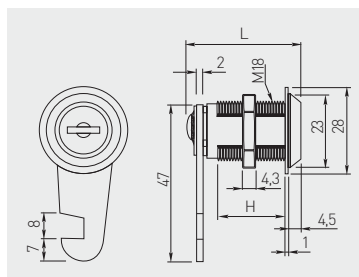

		
ZZ-B0-105-01	chrom / chrome / хром	ZnAl, stal / ZnAl, steel / ZnAl, сталь

Zamek Z-103 skrzynekowy
 Box lock Z-103
 Замок Z-103



				
ZZ-16-103-01	27	12	chrom / chrome / хром	ZnAl, stal / ZnAl, steel / ZnAl, сталь
ZZ-20-103-01	30	16,5		
ZZ-30-103-01	40	26,5		

Zamek S-407 do szyb
Glass door lock S-407
Замок S-407 для стеклянной распашной двери

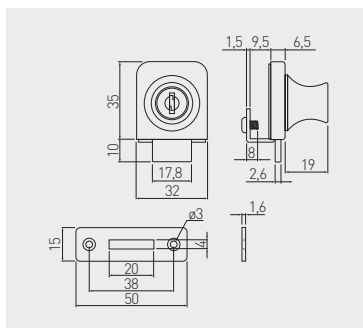

ZZ-SZ-407-01



chrom / chrome / хром



ZnAl, stal / ZnAl, steel / ZnAl, сталь

Zamek S-408 do szyb
Glass door lock S-408
Замок S-408 для стеклянных дверей

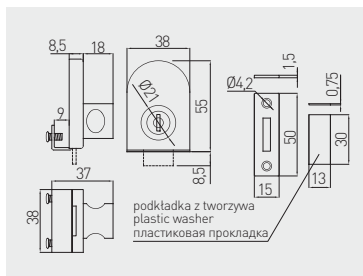

Zastosowanie do szkła 4 - 8 mm
For 4 - 8 mm glass
Толщина стекла 4 - 8 мм



ZZ-SZ-408-01



chrom / chrome / хром



ZnAl, stal / ZnAl, steel / ZnAl, сталь

Zamek S-409 do szyb
Glass door lock S-409
Замок S-409 для стеклянных дверей

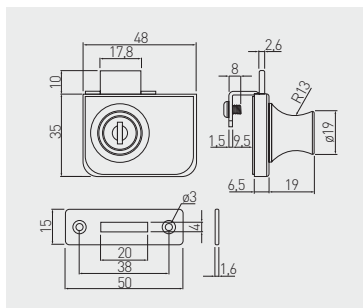

Zastosowanie do szkła 4 - 8 mm
For 4 - 8 mm glass
Толщина стекла 4 - 8 мм



ZZ-SZ-409-01



chrom / chrome / хром



ZnAl, stal / ZnAl, steel / ZnAl, сталь

Zamek M-201
Lock M-201
Замок M-201

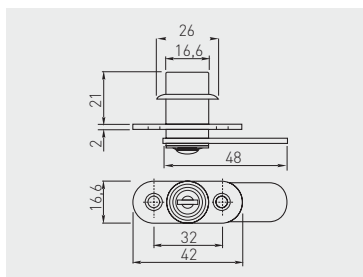

ZZ-M0-201-01



chrom / chrome / хром



ZnAl, stal, plastik / ZnAl, steel, plastic / ZnAl, сталь, пластмасса

Zamek Z-202 zaluzjowy
 Double hook lock Z-202
 Замок Z-202 жалюзийный

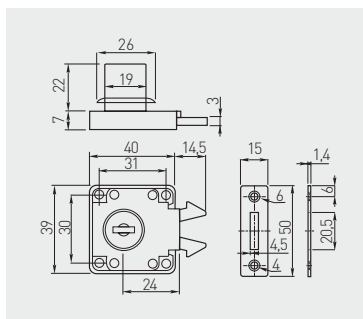

ZZ-Z0-202-01



chrom / chrome / хром



ZnAl, stal, plastik / ZnAl, steel, plastic / ZnAl, сталь, пластмасса

Zamek G-328 grzbietowy
 Sliding glass door lock G-328
 Замок G-328 внутренний

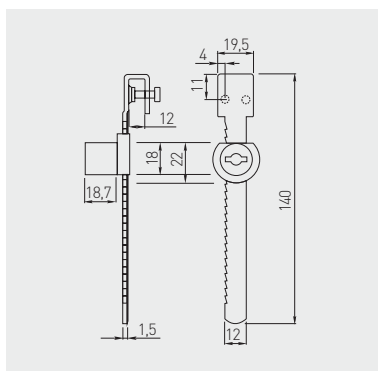

Zastosowanie do szkła 4 - 8 mm
 For 4 - 8 mm glass
 Толщина стекла 4 - 8 мм



ZZ-G0-328-01



chrom / chrome / хром



ZnAl, stal / ZnAl, steel / ZnAl, сталь

Zamek C-288 centralny
Cabinet drawer lock C-288
Замок C-288 центральный боковой

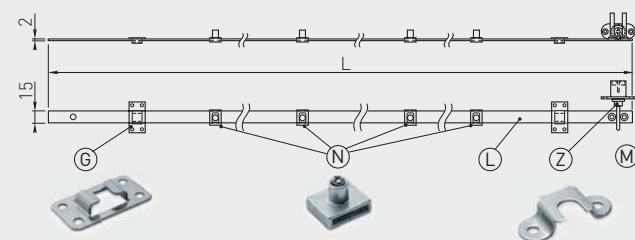

Skład zestawu / Set includes / Состав набора:

- Ⓒ Mocowanie listwy / Slat fixing / Крепление планки
- Ⓓ Blokady szuflady / Drawer locking mechanism / Блокада ящика
- Ⓕ Listwa zamka / Lock slat / Планка замка
- Ⓖ Zamek / Lock / Замок
- Ⓜ Zaczep / Hook / Зацепка

Model	C5	C6	C8	C1
L	500	600	800	1200
N	3	3	4	4
M	3	3	4	4
G	2	2	3	3

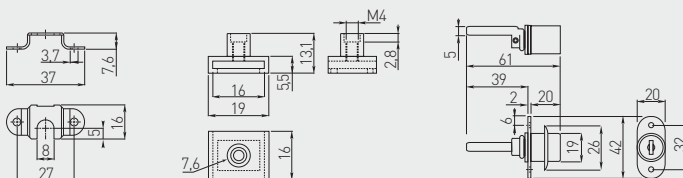

Model	Length (mm)	Finish	Material
ZZ-C5-288-01	500	chrom / chrome / хром	ZnAl, stal / ZnAl, steel / ZnAl, сталь
ZZ-C6-288-01	600		
ZZ-C8-288-01	800		
ZZ-C1-288-01	1200		
ZZ-SP-105-05	-	srebrny / silver / серебристый	stal, plastik / steel, plastic / сталь, пластмасса
ZZ-SP-KLMASTER	-	chrom / chrome / хром	

Zamek baskwilowy
Espagnolette lock
Замок шпингалетный

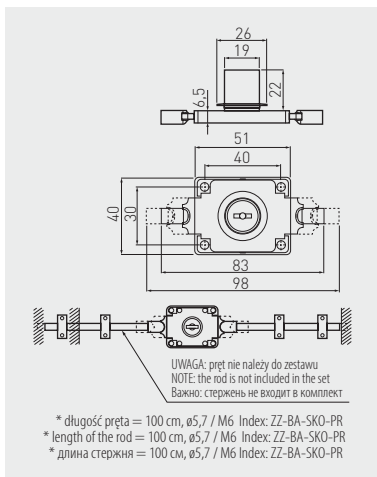

ZZ-BA-SK0-01	chrom / chrome / хром	stal / steel / сталь
ZZ-BA-SK0-PR	osunok / galvanized / гальваника	

Kratka wentylacyjna
Plinth vent
Вентиляционная решётка

NEW

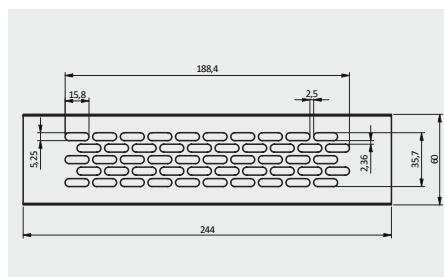





KK-W60245-M0	245	aluminium / aluminium / алюминий	aluminium aluminium алюминий
KK-W60245-M1		biały / white / белый	
KK-W60245-M2		czarny / black / чёрный	
KK-W60245-M6		stal szczotkowana / brushed steel / шлифованная сталь	

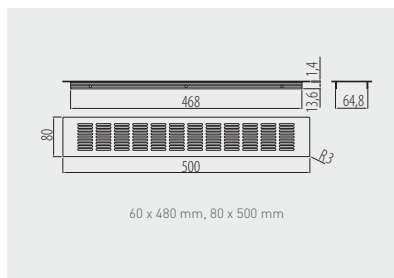

Kratka wentylacyjna D50-80
Plinth vent D50-80
Вентиляционная решётка D50-80







60 x 480 mm, 80 x 500 mm

 KK-D50-80-06	 przepustowość powietrza – 108 cm ² air throughput – 108 cm ² прохождение воздушного потока – 108 см ²	 stal szczotkowana brushed steel шлифованная сталь	 aluminium aluminium алюминий
---	---	--	---

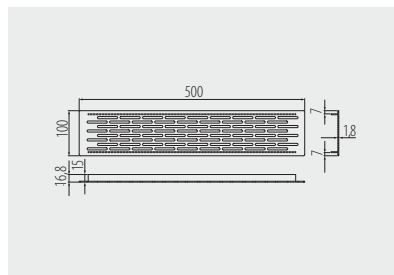

Kratka wentylacyjna D50-100
Plinth vent D50-100
Вентиляционная решётка D50-100







 KK-D50100-06	 przepustowość powietrza – 130 cm ² air throughput – 130 cm ² прохождение воздушного потока – 130 см ²	 stal szczotkowana brushed steel шлифованная сталь	 aluminium aluminium алюминий
---	---	--	---

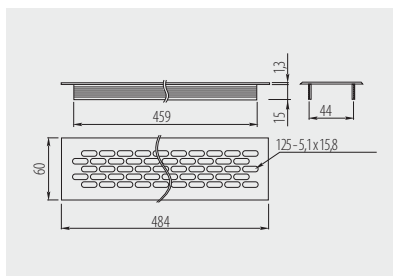

Kratka wentylacyjna W60
Plinth vent W60
Вентиляционная решётка W60





			
KK-W60800-M0	przepustowość powietrza – 94 cm ² air throughput – 94 cm ²	szary / gray / серый	aluminium aluminium
KK-W60800-M1	прохождение воздушного потока – 94 см ²	biały / white / белый	aluminium алюминий

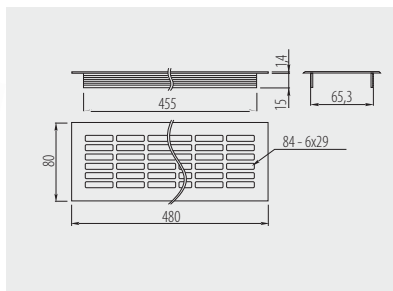

Kratka wentylacyjna W80
Plinth vent W80
Вентиляционная решётка W80







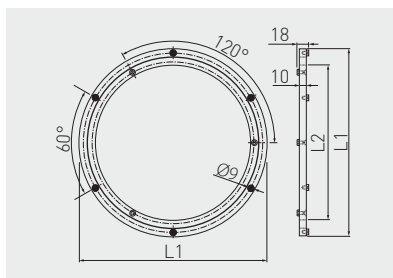

			
KK-W80800-D0	przepustowość powietrza – 146 cm ² air throughput – 146 cm ²	szary / gray / серый	aluminium aluminium
KK-W80800-D1	прохождение воздушного потока – 146 см ²	biały / white / белый	aluminium алюминий



Obrotnica okrągła
Round swivel bracket
Круглый поворотный кронштейн







	 L1 mm	 L2 mm	 kg		
OM-OB0300-05	300	248	60	aluminium aluminium алюминий	aluminium aluminium алюминий
OM-OB0350-05	350	298	80		
OM-OB0400-05	400	338	100		

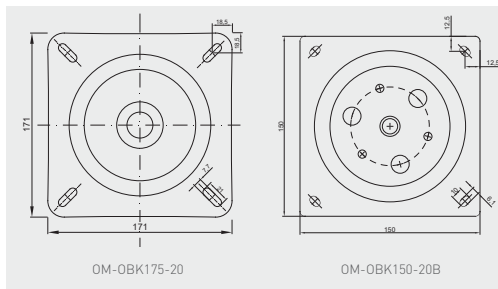

Obrotnica kwadratowa
Square swivel bracket
Поворотный кронштейн, квадратный



	 kg		
OM-OBK150-20B	50	czarny black чёрный	stal steel сталь
OM-OBK175-20*	100		





MB
MILNER BROS.

**AKCESORIA DEKORACYJNE
DECORATIVE ACCESSORIES
ЛИЦЕВАЯ ФУРНИТУРА**

Uchwyty Handles Ручки	266 – 347
Wieszaki Hooks Крючки	348 – 364
Wsporniki Shelf supports Полкодержатели	365 – 371
Nóżki meblowe Furniture legs Мебельные ножки	372 – 400
Nogi meblowe Furniture legs Мебельные опоры	401 – 409
Rolki meblowe Furniture castors Мебельные колёсики	410 – 415





GTV

Uchwyt CLEO
Handle CLEO
Ручка CLEO



finalist
of the competition



2017

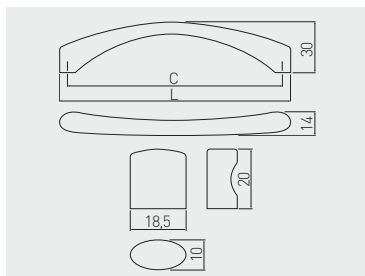

C
mm

L
mm



C	L	chrom chrome хром	aluminium aluminium алюминий	stal szcztokowana brushed steel шлифованная сталь	ZnAl
128	137	UZ-CLE0-128-01	UZ-CLE0-128-05	UZ-CLE0-128-06	ZnAl
160	169	UZ-CLE0-160-01	UZ-CLE0-160-05	UZ-CLE0-160-06	
192	201	UZ-CLE0-192-01	UZ-CLE0-192-05	UZ-CLE0-192-06	
gatka knob ручка		GZ-CLE0-1-01	GZ-CLE0-1-05	GZ-CLE0-1-06	

Uchwyt VETA
Handle VETA
Ручка VETA

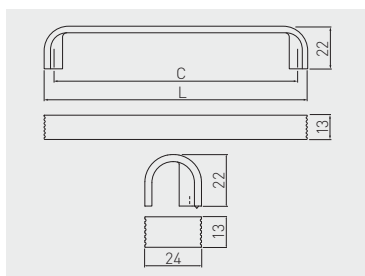

C
mm

L
mm



C	L	chrom chrome хром	aluminium aluminium алюминий	czarny chrom black chrome чёрный хром	ZnAl
128	138	UZ-VETA-128-01	UZ-VETA-128-05	UZ-VETA-128-12	ZnAl
160	170	UZ-VETA-160-01	UZ-VETA-160-05	UZ-VETA-160-12	
320	330	UZ-VETA-320-01	UZ-VETA-320-05	UZ-VETA-320-12	
gatka knob ручка		GZ-VETA-1-01	GZ-VETA-1-05	GZ-VETA-1-12	

Uchwyt HILL
Handle HILL
Ручка HILL

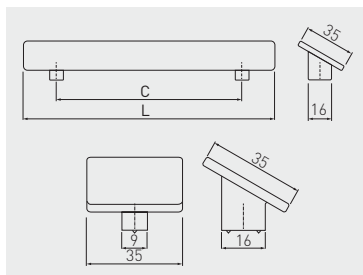

C mm	L mm					
		chrom chrome хром	aluminium aluminium алюминий	stal szorstkowana brushed steel шлифованная сталь	czarny chrom black chrome чёрный хром	ZnAl
128	173	UZ-HILL-128-01	UZ-HILL-128-05	UZ-HILL-128-06	UZ-HILL-128-12	
160	205	UZ-HILL-160-01	UZ-HILL-160-05	UZ-HILL-160-06	UZ-HILL-160-12	
gatka knob ручка	-	GZ-HILL-1-01	GZ-HILL-1-05	GZ-HILL-1-06	GZ-HILL-1-12	



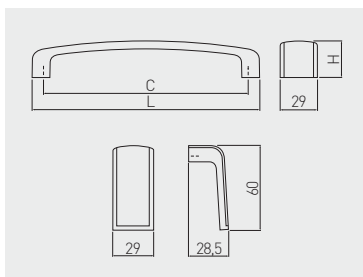

Uchwyt MONZA
Handle MONZA
Ручка MONZA

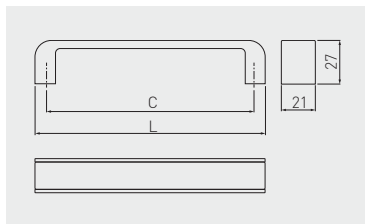

C mm	L mm	H mm				
			stal szorstkowana, chrom brushed steel, chrome шлифованная сталь, хром	biały, chrom white, chrome белый, хром	czarny, chrom black, chrome чёрный, хром	ZnAl, aluminium ZnAl, aluminium ZnAl, алюминий
16	29	28,5	UZ-MONZA16-06	UZ-MONZA16-10	UZ-MONZA16-20	
160	178	29	UZ-MONZA160-06	UZ-MONZA160-10	UZ-MONZA160-20	
256	274	33	UZ-MONZA256-06	UZ-MONZA256-10	UZ-MONZA256-20	
384	402	34	UZ-MONZA384-06	UZ-MONZA384-10	UZ-MONZA384-20	





Uchwyt MONA
Handle MONA
Ручка MONA

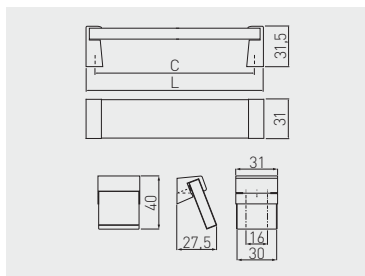

 C mm	 L mm		
		chrom, biały chrome, white хром, белый	chrom, czarny chrome, black хром, чёрный
128	142	UZ-MONA-128-01-10	UZ-MONA-128-01-20
192	206	UZ-MONA-192-01-10	UZ-MONA-192-01-20
256	270	UZ-MONA-256-01-10	UZ-MONA-256-01-20

Uchwyt OLIVA
Handle OLIVA
Ручка OLIVA



 C mm	 L mm		
		chrom chrome хром	
160	174	UZ-0160PR-01	ZnAl, akryl ZnAl, acryl ZnAl, акрил
192	207	UZ-0192PR-01	
256	271	UZ-0256PR-01	
gałka knob ручка	-	GZ-OLIVA-16-01*	

* Produkt dostępny na indywidualne zamówienie / Available for special orders / Товар доступен под заказ

Uchwyt ROSES
Handle ROSES
Ручка ROSES

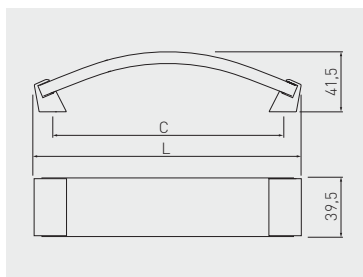

C mm	L mm				
160	185	chrom, szkło przezroczyste chrome, transparent glass хром, прозрачное стекло	chrom, szkło białe chrome, white glass хром, белое стекло	czarny, szkło czarne black, black glass чёрный, черное стекло	ZnAl, szkło ZnAl, glass ZnAl, стекло
256	280	UZ-R160PR-01	UZ-R160BI-01	UZ-ROS160-20	
		UZ-R256PR-01	UZ-R256BI-01	UZ-ROS256-20	

Uchwyt ASTI
Handle ASTI
Ручка ASTI

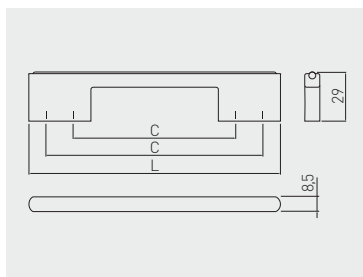

C mm	L mm			
96 / 128	148	chrom chrome хром		ZnAl
192 / 224	245	UZ-ASTI096/128-01		
288 / 320	340	UZ-ASTI192/224-01		
		UZ-ASTI288/320-01		

Uchwyt ARES
Handle ARES
Ручка ARES

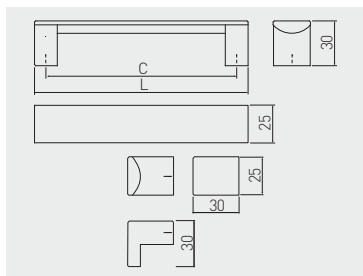

C mm	L mm		
		czarny black чёрный	aluminium aluminium алюминий
96	111	UA-ARS096-20	
128	143	UA-ARS128-20	
160	175	UA-ARS160-20	
192	207	UA-ARS192-20	
224	239	UA-ARS224-20	

C mm	L mm		
		czarny black чёрный	aluminium aluminium алюминий
256	271	UA-ARS256-20	
320	335	UA-ARS320-20	
gatka knob ручка		UA-ARSG30-20	

Uchwyt UZ-G2
Handle UZ-G2
Ручка UZ-G2

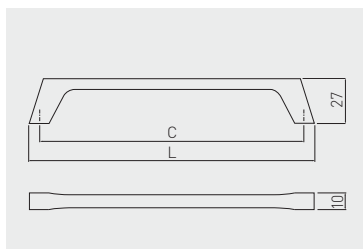

C mm	L mm		
		chrom chrome хром	stal szczotkowana brushed steel шлифованная сталь
160	172	UZ-G2-160-01	UZ-G2-160-06
224	236	UZ-G2-224-01	UZ-G2-224-06

ZnAl



Uchwyt TIVOLI
Handle TIVOLI
Ручка TIVOLI

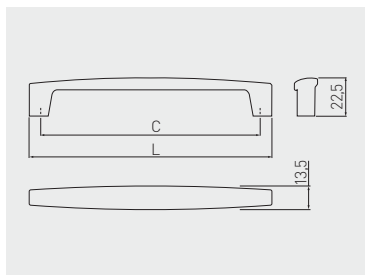

C mm	L mm				
		chrom chrome хром	czarny chrom black chrome чёрный хром	tytan titanium титан	ZnAl
192	206	UZ-TIVOL-192-01	UZ-TIVOL-192-12	UZ-TIVOL-192-13	
320	334	UZ-TIVOL-320-01	UZ-TIVOL-320-12	UZ-TIVOL-320-13	

Uchwyt PRATO
Handle PRATO
Ручка PRATO

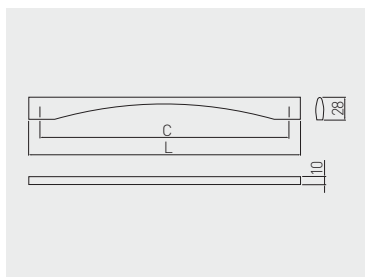

C mm	L mm				
		chrom chrome хром	stal szczotkowana brushed steel шлифованная сталь		ZnAl
160	189	UZ-PRATO-160-01	UZ-PRATO-160-06		
320	349	UZ-PRATO-320-01	UZ-PRATO-320-06		

Uchwyt BAGIO
Handle BAGIO
Ручка BAGIO

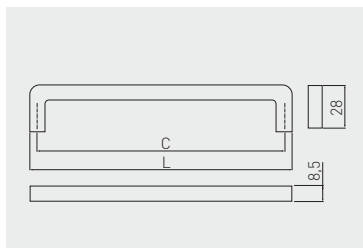





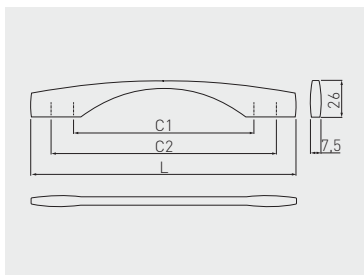

C mm	L mm					
		chrom chrome хром	antyczny miedz antique brass античная латунь	aluminium aluminium алюминий	stal szczotkowana brushed steel шлифованная сталь	ZnAl
128	136	UZ-BAGIO-128-01	UZ-BAGIO-128-04	UZ-BAGIO-128-05	UZ-BAGIO-128-06	
160	168	UZ-BAGIO-160-01	UZ-BAGIO-160-04	UZ-BAGIO-160-05	UZ-BAGIO-160-06	
192	200	UZ-BAGIO-192-01	UZ-BAGIO-192-04	UZ-BAGIO-192-05	UZ-BAGIO-192-06	
320	328	UZ-BAGIO-320-01	UZ-BAGIO-320-04	UZ-BAGIO-320-05	UZ-BAGIO-320-06	

C mm	L mm					
		antyczne srebro antique silver античное серебро	tytan szczotkowany brushed titanium шлифованный титан	czarny mat black matt чёрный матовый		ZnAl
128	136	UZ-BAGIO-128-07	UZ-BAGIO-128-11	UZ-BAGIO-128-20M		
160	168	UZ-BAGIO-160-07	UZ-BAGIO-160-11	UZ-BAGIO-160-20M		
192	200	UZ-BAGIO-192-07	UZ-BAGIO-192-11	UZ-BAGIO-192-20M		
320	328	UZ-BAGIO-320-07	UZ-BAGIO-320-11	UZ-BAGIO-320-20M		







Uchwyt ANCONA
Handle ANCONA
Ручка ANCONA

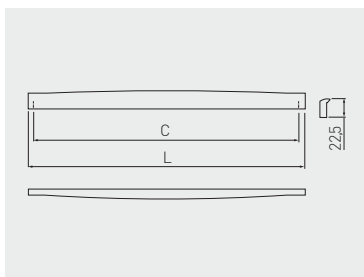

 C1 mm	 C2 mm	 L mm				
			chrom chrome хром	aluminium aluminium алюминий	stal szcztokowana brushed steel шлифованная сталь	ZnAl
128	160	190	UZ-ANCON-128-01	UZ-ANCON-128-05	UZ-ANCON-128-06	
192	224	254	UZ-ANCON-192-01	UZ-ANCON-192-05	UZ-ANCON-192-06	
256	288	318	UZ-ANCON-256-01	UZ-ANCON-256-05	UZ-ANCON-256-06	

Uchwyt KATANIA
Handle KATANIA
Ручка KATANIA



 C mm	 L mm			
		chrom chrome хром	czarny chrom black chrome чёрный хром	ZnAl
320	334	UZ-KATAN-320-01	UZ-KATAN-320-12	

Gatka IMOLA
Knob IMOLA
Ручка IMOLA

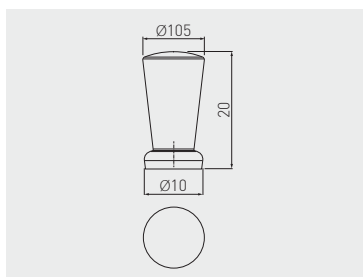

MODERN

	chrom chrome хром	satyna satin сатин	aluminium aluminium алюминий	stal szorstkowana brushed steel шлифованная сталь	ZnAl
gatka knob ручка	GZ-IMOLA-1-01	GZ-IMOLA-1-02	GZ-IMOLA-1-05	GZ-IMOLA-1-06	

Gatka ROMA
Knob ROMA
Ручка ROMA

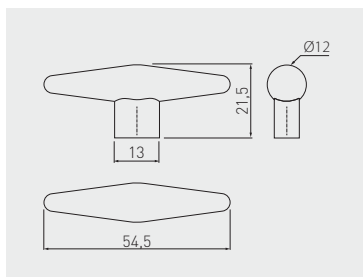

	chrom chrome хром	satyna satin сатин	aluminium aluminium алюминий	stal szorstkowana brushed steel шлифованная сталь	ZnAl
gatka knob ручка	GZ-ROMA-1-01	GZ-ROMA-1-02	GZ-ROMA-1-05	GZ-ROMA-1-06	

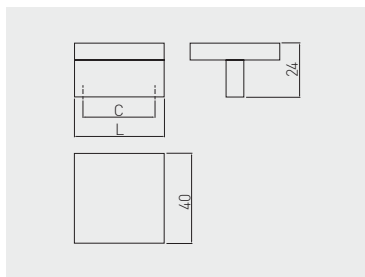

Uchwyt UZ-40
Handle UZ-40
Ручка UZ-40

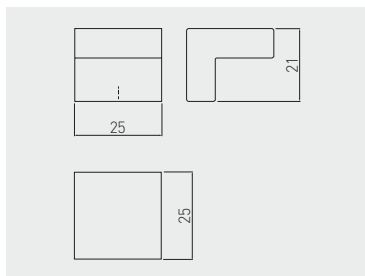

						
32	40	chrom chrome хром	satyna satin сатин	aluminium aluminium алюминий	stal szorstkowana brushed steel шлифованная сталь	ZnAl
		UZ-40-032-01	UZ-40-032-02	UZ-40-032-05	UZ-40-032-06	

Uchwyt UZ-55
Handle UZ-55
Ручка UZ-55



					
gatka knob ручка	25	chrom chrome хром		aluminium aluminium алюминий	ZnAl
		UZ-55-025-01		UZ-55-025-05	

Uchwyt UZ-60
Handle UZ-60
Ручка UZ-60

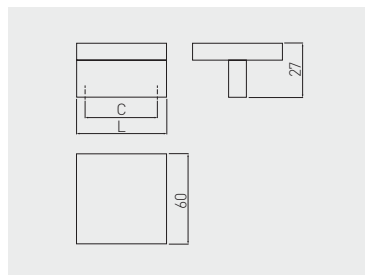

C mm	L mm					
		chrom chrome хром	satyna satin сатин	aluminium aluminium алюминий	stal szcztokowana brushed steel шлифованная сталь	ZnAl
32	60	UZ-60-032-01	UZ-60-032-02	UZ-60-032-05	UZ-60-032-06	

Uchwyt MODENA
Handle MODENA
Ручка MODENA

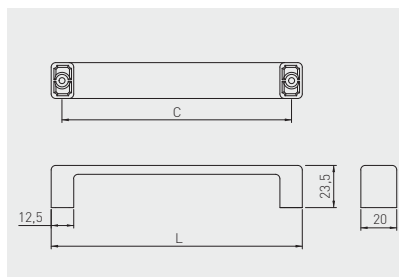

C mm	L mm					
C	L	chrom chrome хром	aluminium aluminium алюминий	stal szcztokowana brushed steel шлифованная сталь	czarny mat black matt чёрный матовый	ZnAl
128	140	UZ-MODEN-128-01	UZ-MODEN-128-05	UZ-MODEN-128-06	UZ-MODEN-128-20M	
160	172	UZ-MODEN-160-01	UZ-MODEN-160-05	UZ-MODEN-160-06	UZ-MODEN-160-20M	
192	204	UZ-MODEN-192-01	UZ-MODEN-192-05	UZ-MODEN-192-06	UZ-MODEN-192-20M	

Uchwyt VARES
Handle VARES
Ручка VARES

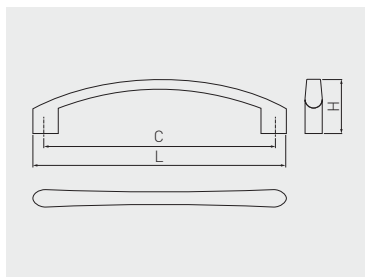

	C mm	L mm	H mm	chrom chrome хром	satyna satin сатин	aluminium aluminium алюминий	stal szczotkowana brushed steel шлифованная сталь	ZnAl
96	109	29		UZ-VARES-96-01	UZ-VARES-96-02	UZ-VARES-96-05	UZ-VARES-96-06	
128	140	30		UZ-VARES-128-01	UZ-VARES-128-02	UZ-VARES-128-05	UZ-VARES-128-06	
192	208	31		UZ-VARES-192-01	UZ-VARES-192-02	UZ-VARES-192-05	UZ-VARES-192-06	

Uchwyt UZ-133
Handle UZ-133
Ручка UZ-133

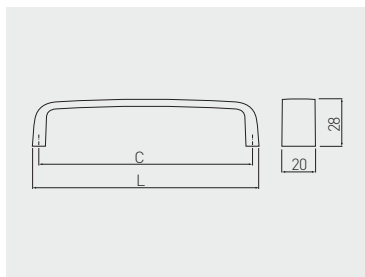

	C mm	L mm		chrom chrome хром	satyna satin сатин	aluminium aluminium алюминий	stal szczotkowana brushed steel шлифованная сталь	ZnAl
128	135			UZ-133128-01	UZ-133128-02	UZ-133128-05	UZ-133128-06	



Uchwyt UZ-334
Handle UZ-334
Ручка UZ-334

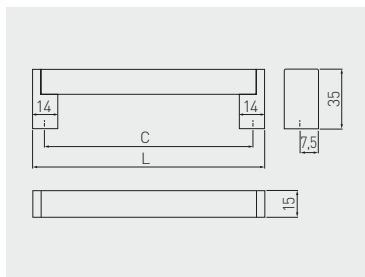

C mm	L mm		
		stal szczotkowana brushed steel шлифованная сталь	ZnAl, stal ZnAl, steel ZnAl, сталь
128	144	UZ-334128-06	
160	175	UZ-334160-06	
192	206	UZ-334192-06	
256	272	UZ-334256-06	
320	335	UZ-334320-06	

Uchwyt UZ-335
Handle UZ-335
Ручка UZ-335

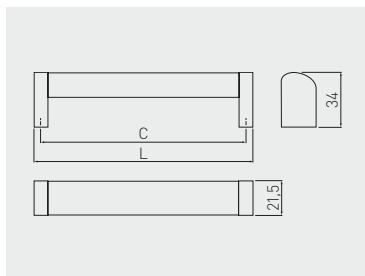

C mm	L mm		
		stal szczotkowana brushed steel шлифованная сталь	ZnAl, stal ZnAl, steel ZnAl, сталь
128	137	UZ-335128-06	
160	169	UZ-335160-06	
192	201	UZ-335192-06	
256	265	UZ-335256-06	

Uchwyt UZ-336
Handle UZ-336
Ручка UZ-336

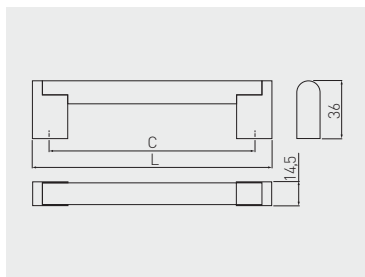

C mm	L mm			
		stal szcztokowana brushed steel шлифованная сталь		
128	148	UZ-336128-06	ZnAl, stal ZnAl, steel ZnAl, сталь	
160	182	UZ-336160-06		
192	213	UZ-336192-06		
256	276	UZ-336256-06		
320	340	UZ-336320-06		
416	436	UZ-336416-06		
480	500	UZ-336480-06		

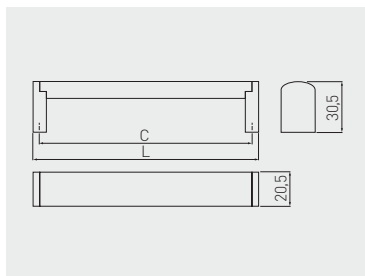

Uchwyt UZ-682
Handle UZ-682
Ручка UZ-682

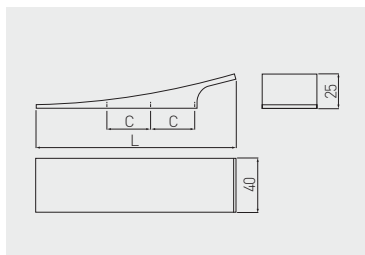

C mm	L mm			C mm	L mm		
		stal szcztokowana brushed steel шлифованная сталь				stal szcztokowana brushed steel шлифованная сталь	
128	136	UZ-682128-06	stal, ZnAl steel, ZnAl сталь, ZnAl	256	266	UZ-682256-06	stal, ZnAl steel, ZnAl сталь, ZnAl
160	170	UZ-682160-06		320	329	UZ-682320-06	
192	209	UZ-682192-06		416	425	UZ-682416-06	
224	232	UZ-682224-06		480	489	UZ-682480-06	

Uchwyt UZ-804
Handle UZ-804
Ручка UZ-804





C mm	L mm		
32*	145	chrom chrome хром	ZnAl
		UZ-804064-01	

* Mocowanie na 3 wkręty / Mounted with 3 screws / Крепление на 3 самореза.

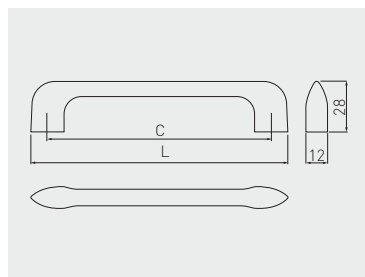
Uchwyt MILANO
Handle MILANO
Ручка MILANO



C mm	L mm					
C	L	chrom chrome хром	aluminium aluminium алюминий	stal szczotkowana brushed steel шлифованная сталь	czarny mat black matt чёрный матовый	ZnAl
128	146	UZ-MILAN-128-01	UZ-MILAN-128-05	UZ-MILAN-128-06	UZ-MILAN-128-20M	
256	274	UZ-MILAN-256-01	UZ-MILAN-256-05	UZ-MILAN-256-06	UZ-MILAN-256-20M	
galka knob ручка		GZ-MILAN-32-01	GZ-MILAN-32-05	GZ-MILAN-32-06	GZ-MILAN-32-20M	

Uchwyt CAPRI
Handle CAPRI
Ручка CAPRI

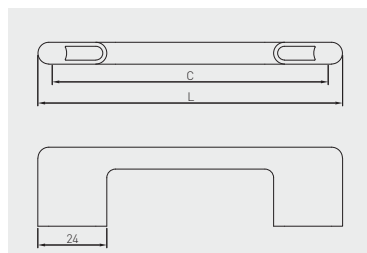

C
mm

L
mm



C	L	chrom chrome хром	satyna satin сатин	aluminium aluminium алюминий	stal szorstkowana brushed steel шлифованная сталь	ZnAl
96	106	UZ-CAPRI-96-01	UZ-CAPRI-96-02	UZ-CAPRI-96-05	UZ-CAPRI-96-06	
128	138	UZ-CAPRI-128-01	UZ-CAPRI-128-02	UZ-CAPRI-128-05	UZ-CAPRI-128-06	
160	170	UZ-CAPRI-160-01	UZ-CAPRI-160-02	UZ-CAPRI-160-05	UZ-CAPRI-160-06	
192	202	UZ-CAPRI-192-01	UZ-CAPRI-192-02	UZ-CAPRI-192-05	UZ-CAPRI-192-06	
256	266	UZ-CAPRI-256-01	UZ-CAPRI-256-02	UZ-CAPRI-256-05	UZ-CAPRI-256-06	
320	330	UZ-CAPRI-320-01	UZ-CAPRI-320-02	UZ-CAPRI-320-05	UZ-CAPRI-320-06	



Uchwyt UZ-819
Handle UZ-819
Ручка UZ-819

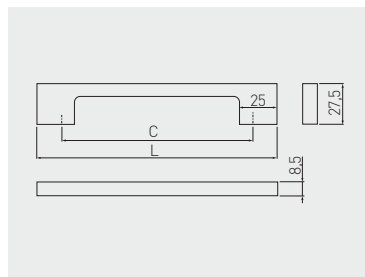

MODERN

C mm	L mm	chrom chrome хром	satyna chrome сатин	aluminium aluminium алюминий	stal szczotkowana brushed steel шлифованная сталь	antyczne srebro antique silver античное серебро	ZnAl
96	129	UZ-819096-01	UZ-819096-02	UZ-819096-05	UZ-819096-06	UZ-819096-07	
128	161	UZ-819128-01	UZ-819128-02	UZ-819128-05	UZ-819128-06	UZ-819128-07	
160	193	UZ-819160-01	UZ-819160-02	UZ-819160-05	UZ-819160-06	UZ-819160-07	
192	225	UZ-819192-01	UZ-819192-02	UZ-819192-05	UZ-819192-06	UZ-819192-07	
256	289	UZ-819256-01	UZ-819256-02	UZ-819256-05	UZ-819256-06	UZ-819256-07	
320	353	UZ-819320-01	UZ-819320-02	UZ-819320-05	UZ-819320-06	UZ-819320-07	

C mm	L mm	biały white белый	czarny black чёрный	czarny chrom black chrome чёрный хром	antyczna miedź antique copper античная медь	miedź copper медь	ZnAl
96	129	UZ-819096-10	UZ-819096-20	UZ-819096-12	UZ-819096-14	-	
128	161	UZ-819128-10	UZ-819128-20	UZ-819128-12	UZ-819128-14	UZ-819128-15	
160	193	UZ-819160-10	UZ-819160-20	UZ-819160-12	UZ-819160-14	UZ-819160-15	
192	225	UZ-819192-10	UZ-819192-20	UZ-819192-12	UZ-819192-14	UZ-819192-15	
256	289	UZ-819256-10	UZ-819256-20	UZ-819256-12	UZ-819256-14	UZ-819256-15	
320	353	UZ-819320-10	UZ-819320-20	UZ-819320-12	UZ-819320-14	-	

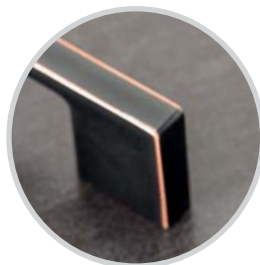

antyczna miedź
antique copper
античная медь



miedź
copper
медь



Uchwyt UZ-870
Handle UZ-870
Ручка UZ-870

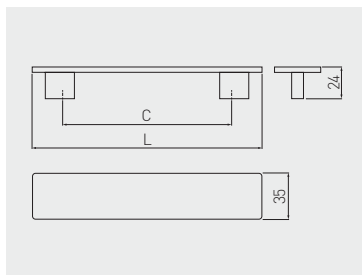

C mm	L mm		
128	174	chrom chrome хром	ZnAl
		UZ-870128-01	

Uchwyt UZ-872
Handle UZ-872
Ручка UZ-872

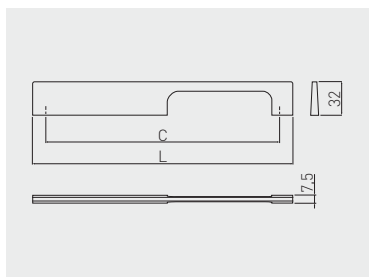
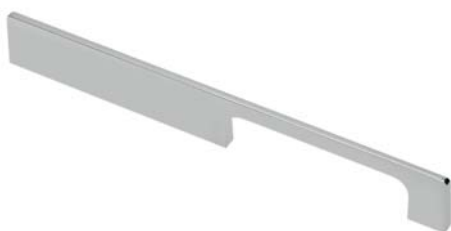

C mm	L mm		
224	249	chrom chrome хром	aluminium aluminium алюминий
		stal szcztkowana brushed steel шлифованная сталь	ZnAl
		UZ-872224-01	UZ-872224-05
		UZ-872224-06	

Uchwyt EAST*
Handle EAST*
Ручка EAST*

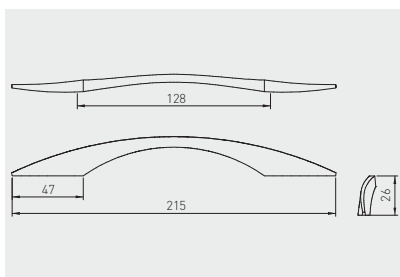

C mm	L mm				
		chrom chrome хром	stal szcztkowana brushed steel шлифованная сталь	szary mat grey matt серый матовый	ZnAl
128	215	UZ-EAST-128-01	UZ-EAST-128-06	UZ-EAST-128-19	

* Produkt dostępny na indywidualne zamówienie / Available for special orders / Товар доступен под заказ

Uchwyt UZ-880
Handle UZ-880
Ручка UZ-880

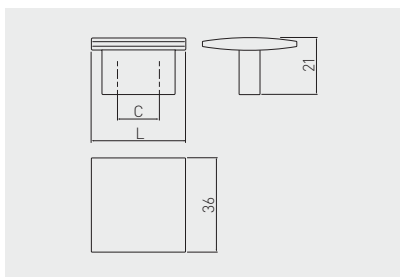

C mm	L mm			
		chrom chrome хром		ZnAl
16	36	UZ-880016-01		

Uchwyt UZ-883
Handle UZ-883
Ручка UZ-883

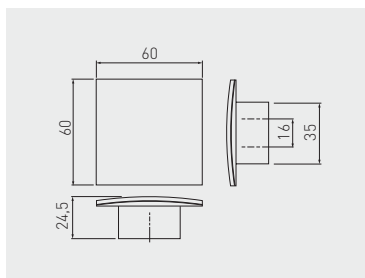

C mm	L mm					
		chrom chrome хром	satyna satin сатин	aluminium aluminium алюминий	stal szczotkowana brushed steel шлифованная сталь	ZnAl
16	60	UZ-883016-01	UZ-883016-02	UZ-883016-05	UZ-883016-06	

Uchwyt UA-A3
Handle UA-A3
Ручка UA-A3

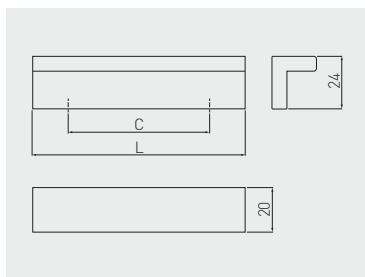

C mm	L mm		
		aluminium aluminium алюминий	aluminium aluminium алюминий
96	128	UA-A3-096128	
128	160	UA-A3-128160	
160	192	UA-A3-160192	
192	224	UA-A3-192224	
256	288	UA-A3-256288	
320	352	UA-A3-320352	

Uchwyt UA-B311
Handle UA-B311
Ручка UA-B311

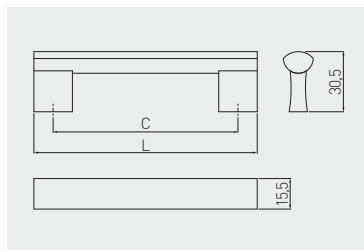

C mm	L mm	chrom chrome хром	aluminium aluminium алюминий	czarny black чёрный	stal szczotkowana brushed steel шлифованная сталь	
96	116	*	UA-B0-311096	UA-B0-311096-20M	UA-B31109606MJ*	aluminium aluminium алюминий
128	148	UA-B31112801	UA-B0-311128	UA-B0-311128-20M	UA-B31112806MJ*	
160	180	UA-B31116001	UA-B0-311160	UA-B0-311160-20M	UA-B31116006MJ*	
192	212	UA-B31119201	UA-B0-311192	UA-B0-311192-20M	UA-B31119206MJ*	
224	244	UA-B31122401	UA-B0-311224	UA-B0-311224-20M	UA-B31122406MJ*	
256	276	UA-B31125601	UA-B0-311256	UA-B0-311256-20M	UA-B31125606MJ*	
288	307	*	UA-B0-311288	*	UA-B31128806MJ*	
320	340	UA-B31132001	UA-B0-311320	UA-B0-311320-20M	UA-B31132006MJ*	
480	500	*	UA-B0-311480	*	UA-B31148006MJ*	

* Produkt dostępny na indywidualne zamówienie / Available for special orders / Товар доступен под заказ

Uchwyt UA-114
Handle UA-114
Ручка UA-114

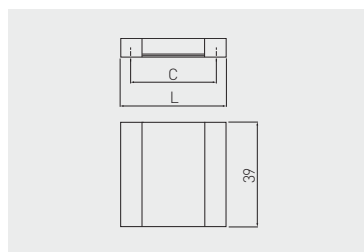

C mm	L mm	satyna satin сатин	aluminium aluminium алюминий	aluminium aluminium алюминий
32	39	UA-AA-114-02	UA-AA-114-05	

Uchwyt UA-18
Handle UA-18
Ручка UA-18

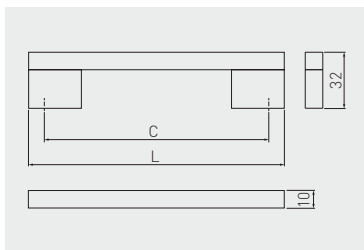

C
mm

L
mm



C mm	L mm	chrom chrome хром	aluminium aluminium алюминий	stal szorstkowana brushed steel шлифованная сталь	
128	146	UA-A18128-01	UA-18-128146	UA-A18128-06MJ	aluminium aluminium алюминий
160	178	UA-A18160-01	UA-18-160178	UA-A18160-06MJ	
192	210	UA-A18192-01	UA-18-192210	UA-A18192-06MJ	
224	242	UA-A18224-01	UA-18-224242	UA-A18224-06MJ	
256	274	UA-A18256-01	UA-18-256274	UA-A18256-06MJ	
320	338	UA-A18320-01	UA-18-320338	UA-A18320-06MJ	
400	418	UA-A18400-01	UA-18-400418	UA-A18400-06MJ	
416	434	UA-A18416-01	UA-18-416434	UA-A18416-06MJ	
480	498	UA-A18480-01	UA-18-480498	UA-A18480-06MJ	

Uchwyt UA-313
Handle UA-313
Ручка UA-313

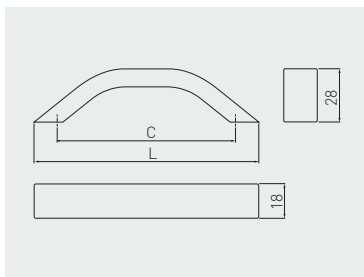

C
mm





L
mm

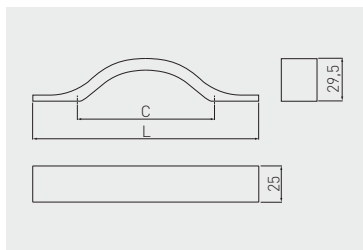

C mm	L mm	aluminium aluminium алюминий	
128	150	UA-00-313128	aluminium aluminium алюминий
160	182	UA-00-313160	
192	214	UA-00-313192	





Uchwyt UA-319
Handle UA-319
Ручка UA-319

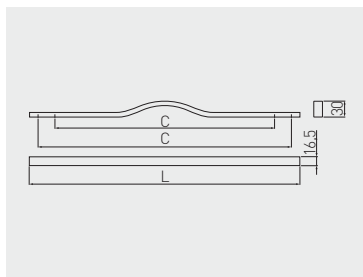

 C mm	 L mm		
		aluminium aluminium алюминий	aluminium aluminium алюминий
96	158	UA-00-319096	
128	189	UA-00-319128	
160	231	UA-00-319160	

Uchwyt DOPPIO
Handle DOPPIO
Ручка DOPPIO



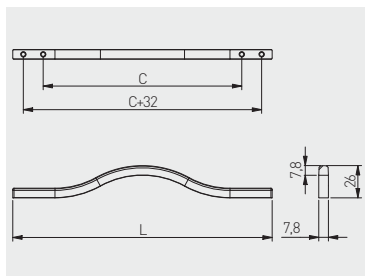

 C mm	 L mm		
		chrom, aluminium chrome, aluminium хром, алюминий	aluminium aluminium алюминий
192 / 224	256	UA-DOPPIO192-01	
416 / 480	512	UA-DOPPIO416-01	

Uchwyt VITO
Handle VITO
Ручка VITO



 C mm	 L mm				
		chrom chrome хром	aluminium aluminium алюминий	antyczne srebro antique silver античное серебро	ZnAl
160	210	UZ-VITO-160-01	UZ-VITO-160-05	UZ-VITO-160-07	
288	340	UZ-VITO-288-01	UZ-VITO-288-05	UZ-VITO-288-07	

 C mm	 L mm				
		czarny chrom black chrome чёрный хром	czarny mat black matt чёрный матовый		ZnAl
160	210	UZ-VITO-160-12	UZ-VITO-160-20M		
288	340	UZ-VITO-288-12	UZ-VITO-288-20M		



Uchwyt FLAVIO
Handle FLAVIO
Ручка FLAVIO

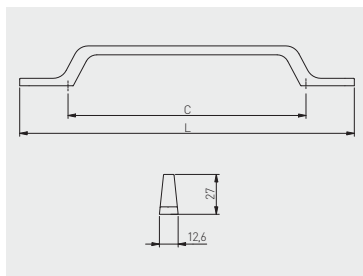

C mm	L mm					
		chrom chrome хром	stal szcztokowana brushed steel шлифованная сталь	złoty mosiądz golden brass золотая латунь	czarny mat black matt чёрный матовый	ZnAl
96	161	UZ-FLAVIO-96-01	UZ-FLAVIO-96-06	UZ-FLAVIO-96-16	UZ-FLAVIO-96-20M	
128	193	UZ-FLAVIO-128-01	UZ-FLAVIO-128-06	UZ-FLAVIO-128-16	UZ-FLAVIO-128-20M	
160	225	UZ-FLAVIO-160-01	UZ-FLAVIO-160-06	UZ-FLAVIO-160-16	UZ-FLAVIO-160-20M	



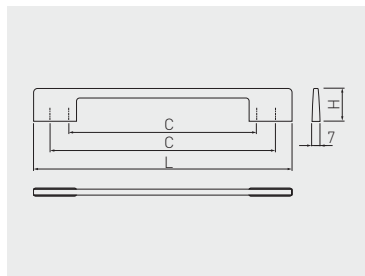

Uchwyt THIN
Handle THIN
Ручка THIN

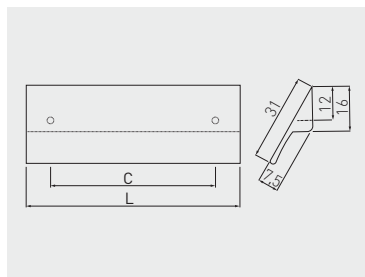

 C mm	 L mm	 H mm				
96/128	156	24	chrom chrome хром	aluminium aluminium алюминий	stal szcztokowana brushed steel шлифованная сталь	ZnAl
160/192	220	28	UZ-TH096128-01	UZ-TH096128-05	UZ-TH096128-06	
288/320	348	28	UZ-TH160192-01	UZ-TH160192-05	UZ-TH160192-06	
			UZ-TH288320-01	UZ-TH288320-05	UZ-TH288320-06	

Uchwyt PICCOLO
Handle PICCOLO
Ручка PICCOLO



 C mm	 L mm		
64	80	aluminium aluminium алюминий	aluminium aluminium алюминий
224	240	UA-PICCO-64-05	
		UA-PICCO-224-05	

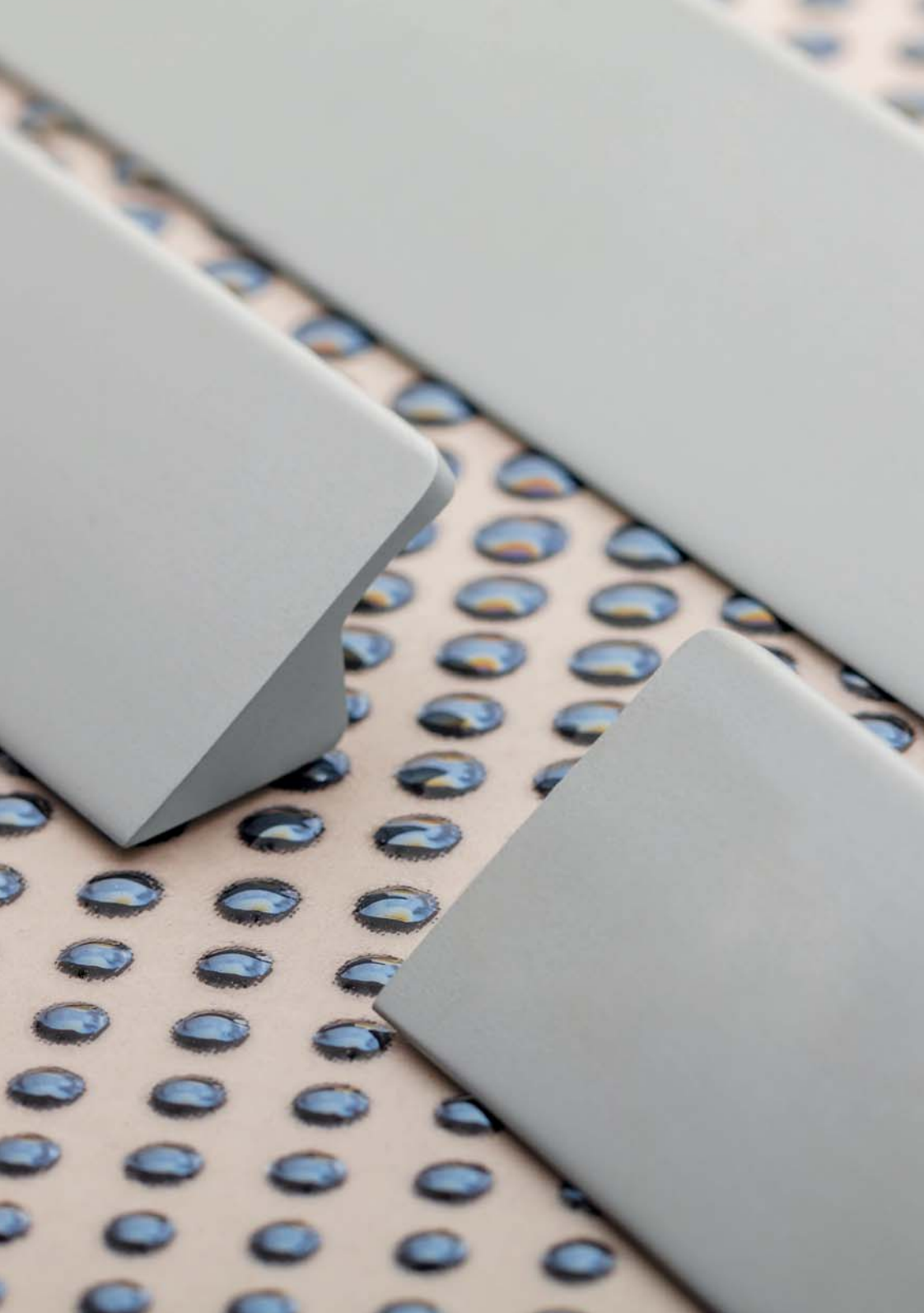

Uchwyt BETA
Handle BETA
Ручка BETA

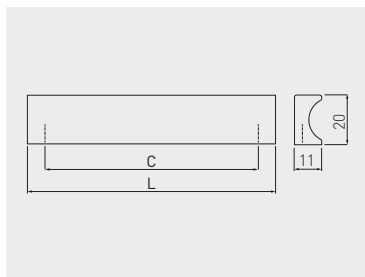

C mm	L mm		
96	110	aluminium aluminium алюминий	aluminium aluminium алюминий
192	206	UA-BETA-192-05	
224	238	UA-BETA-224-05	

C mm	L mm		
256	270	aluminium aluminium алюминий	aluminium aluminium алюминий
288	302	UA-BETA-288-05	
320	334	UA-BETA-320-05	

Uchwyt GAMMA
Handle GAMMA
Ручка GAMMA

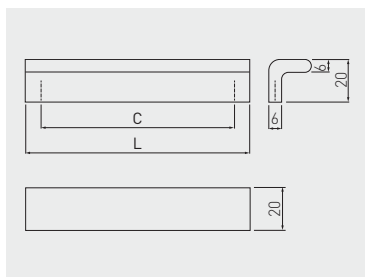

C mm	L mm		
96	110	aluminium aluminium алюминий	aluminium aluminium алюминий
192	206	UA-GAMMA-192-05	
224	238	UA-GAMMA-224-05	

C mm	L mm		
256	270	aluminium aluminium алюминий	aluminium aluminium алюминий
288	302	UA-GAMMA-288-05	
320	334	UA-GAMMA-320-05	

Uchwyt DELTA
Handle DELTA
Ручка DELTA

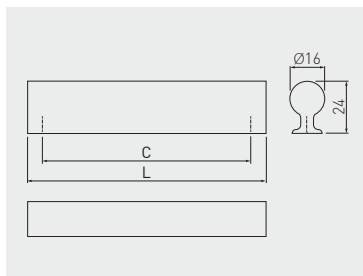

C mm	L mm		
		aluminium aluminium алюминий	aluminium aluminium алюминий
128	142	UA-DELTA-128-05	
160	174	UA-DELTA-160-05	
192	206	UA-DELTA-192-05	

C mm	L mm		
		aluminium aluminium алюминий	aluminium aluminium алюминий
224	238	UA-DELTA-224-05	
256	270	UA-DELTA-256-05	
288	302	UA-DELTA-288-05	
320	334	UA-DELTA-320-05	

Uchwyt SIGMA
Handle SIGMA
Ручка SIGMA

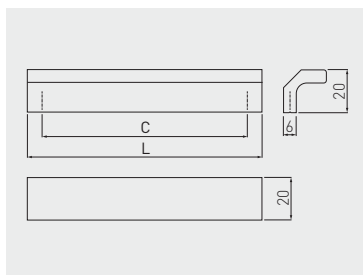



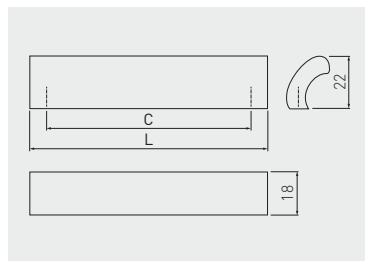

C mm	L mm		
		aluminium aluminium алюминий	aluminium aluminium алюминий
96	110	UA-SIGMA-96-05	
128	142	UA-SIGMA-128-05	
160	174	UA-SIGMA-160-05	
192	206	UA-SIGMA-192-05	

C mm	L mm		
		aluminium aluminium алюминий	aluminium aluminium алюминий
224	238	UA-SIGMA-224-05	
256	270	UA-SIGMA-256-05	
288	302	UA-SIGMA-288-05	
320	334	UA-SIGMA-320-05	





Uchwyt KAPPA
Handle KAPPA
Ручка KAPPA

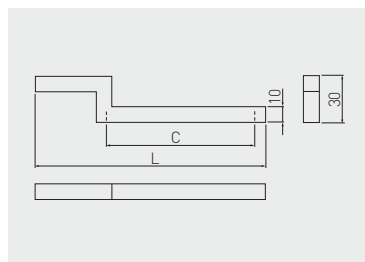

 C mm	 L mm		
96	110	aluminium aluminium алюминий	aluminium aluminium алюминий
128	142	UA-KAPPA-128-05	
160	174	UA-KAPPA-160-05	
192	206	UA-KAPPA-192-05	
224	238	UA-KAPPA-224-05	
256	270	UA-KAPPA-256-05	
288	302	UA-KAPPA-288-05	
320	334	UA-KAPPA-320-05	

Uchwyt ALRA
Handle ALRA
Ручка ALRA



 C mm	 L mm		
96	149	chrom chrome хром	ZnAl
		UZ-ALRA096-01	

Uchwyt UA-337
Handle UA-337
Ручка UA-337

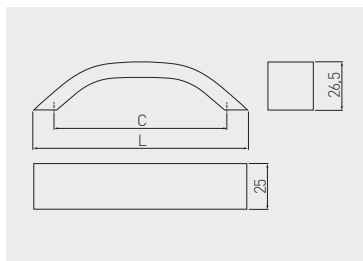

C mm	L mm			
		aluminium aluminium алюминий	czarny black чёрный	aluminium aluminium алюминий
96	116	UA-00-337096	UA-00-337096-20M	
128	146	UA-00-337128	UA-00-337128-20M	
160	180	UA-00-337160	UA-00-337160-20M	
192	212	UA-00-337192	UA-00-337192-20M	
224	244	UA-00-337224	UA-00-337224-20M	
256	275	UA-00-337256	UA-00-337256-20M	
320	340	UA-00-337320	UA-00-337320-20M	



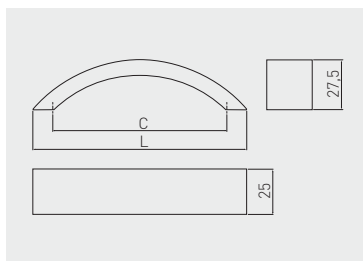

Uchwyt UA-338
Handle UA-338
Ручка UA-338

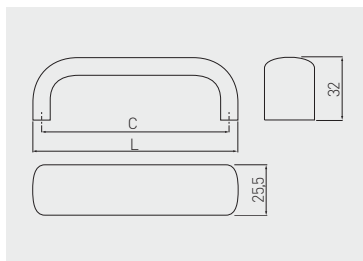

C mm	L mm		
		aluminium aluminium алюминий	aluminium aluminium алюминий
128	137	UA-00-338128	
160	169	UA-00-338160	

Uchwyt UA-340
Handle UA-340
Ручка UA-340



 C mm	 L mm		
		aluminium aluminium алюминий	aluminium aluminium алюминий
128	137	UA-00-340128	
160	169	UA-00-340160	
192	201	UA-00-340192	
224	233	UA-00-340224	
256	265	UA-00-340256	
320	329	UA-00-340320	



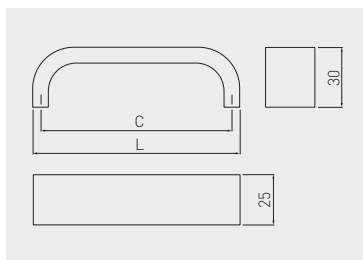

Uchwyt UA-347
Handle UA-347
Ручка UA-347

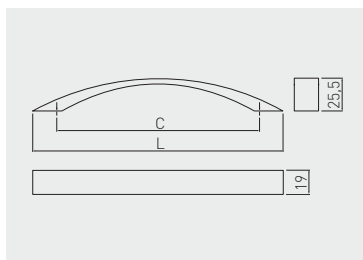

 C mm	 L mm		
		aluminium aluminium алюминий	aluminium aluminium алюминий
128	136	UA-00-347128	
160	168	UA-00-347160	
192	200	UA-00-347192	
224	232	UA-00-347224	
256	264	UA-00-347256	
320	328	UA-00-347320	





Uchwyt CALABRIA
Handle CALABRIA
Ручка CALABRIA

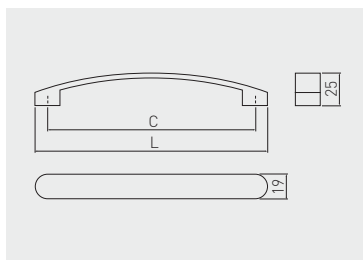

 C mm	 L mm			
		chrom chrome хром	stal szczotkowana brushed steel шлифованная сталь	ZnAl
160	195	UZ-CALABRIA160-01	UZ-CALABRIA160-06	
192	224	UZ-CALABRIA192-01	UZ-CALABRIA192-06	
224	258	UZ-CALABRIA224-01	UZ-CALABRIA224-06	

Uchwyt GENUA
Handle GENUA
Ручка GENUA



 C mm	 L mm				
		chrom chrome хром	satyna satin сатин	aluminium aluminium алюминий	ZnAl
128	148	UZ-GENUA128-01	UZ-GENUA128-02	UZ-GENUA128-05	
160	180	UZ-GENUA160-01	UZ-GENUA160-02	UZ-GENUA160-05	

Uchwyt G0
Handle G0
Ручка G0

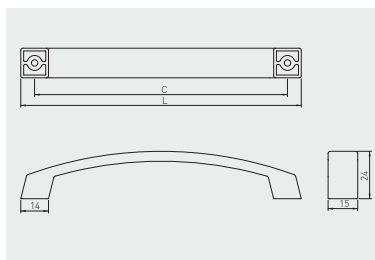

C mm	L mm				
		chrom chrome хром	aluminium aluminium алюминий	stal szczotkowana brushed steel шлифованная сталь	ZnAl
128	142	UZ-G0-128-01	UZ-G0-128-05	UZ-G0-128-06	
160	174	UZ-G0-160-01	UZ-G0-160-05	UZ-G0-160-06	
192	206	UZ-G0-192-01	UZ-G0-192-05	UZ-G0-192-06	
256	270	UZ-G0-256-01	UZ-G0-256-05	UZ-G0-256-06	

Uchwyt UZ-G1
Handle UZ-G1
Ручка UZ-G1

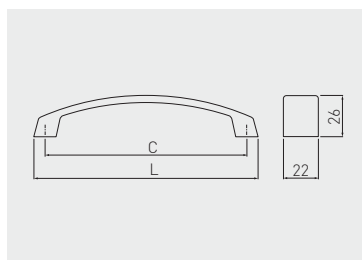

C mm	L mm					
		chrom chrome хром	aluminium aluminium алюминий	stal szczotkowana brushed steel шлифованная сталь	tytan titanium титан	ZnAl
128	142	UZ-G1-128-01	UZ-G1-128-05	UZ-G1-128-06	UZ-G1-128-13	
160	174	UZ-G1-160-01	UZ-G1-160-05	UZ-G1-160-06	UZ-G1-160-13	
192	206	UZ-G1-192-01	UZ-G1-192-05	UZ-G1-192-06	UZ-G1-192-13	
256	270	UZ-G1-256-01	UZ-G1-256-05	UZ-G1-256-06	UZ-G1-256-13	
320	334	UZ-G1-320-01	UZ-G1-320-05	UZ-G1-320-06	UZ-G1-320-13	
416	430	UZ-G1-416-01	UZ-G1-416-05	UZ-G1-416-06	-	

Uchwyt UZ-01
Handle UZ-01
Ручка UZ-01

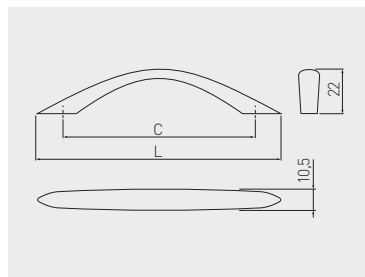

C mm	L mm				
		chrom chrome хром	satyna satin сатин	aluminium aluminium алюминий	ZnAl
96	121	UZ-01-096-01	UZ-01-096-02	UZ-01-096-05	
128	158	UZ-01-128-01	UZ-01-128-02	UZ-01-128-05	

Uchwyt UZ-05
Handle UZ-05
Ручка UZ-05

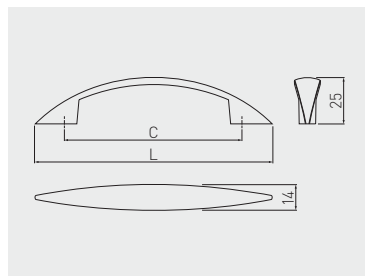

C mm	L mm				
		chrom chrome хром	satyna satin сатин	aluminium aluminium алюминий	ZnAl
96	132	UZ-05-096-01	UZ-05-096-02	UZ-05-096-05	
128	164	UZ-05-128-01	UZ-05-128-02	UZ-05-128-05	

Uchwyt UZ-06
Handle UZ-06
Ручка UZ-06

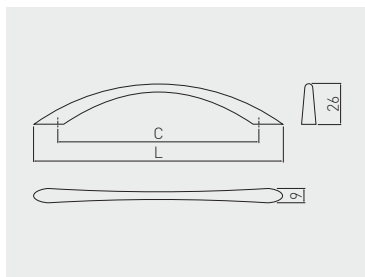

C mm	L mm				
		chrom chrome хром	satyna satin сатин	aluminium aluminium алюминий	ZnAl
128	164	UZ-06-128-01	UZ-06-128-02	UZ-06-128-05	

Uchwyt UZ-07
Handle UZ-07
Ручка UZ-07

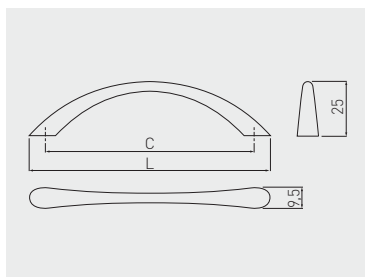

C mm	L mm				
		chrom chrome хром	satyna satin сатин	aluminium aluminium алюминий	ZnAl
96	111	UZ-07-096-01	UZ-07-096-02	UZ-07-096-05	

Uchwyt UZ-Z10
Handle UZ-Z10
Ручка UZ-Z10

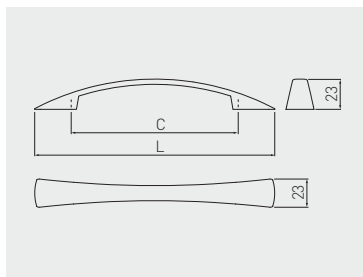

C mm	L mm				
96	138	chrom chrome хром	satyna satin сатин	aluminium aluminium алюминий	ZnAl
		UZ-Z10096-01	UZ-Z10096-02	UZ-Z10096-05	
128	184	UZ-Z10128-01	UZ-Z10128-02	UZ-Z10128-05	

Uchwyt UZ-13
Handle UZ-13
Ручка UZ-13

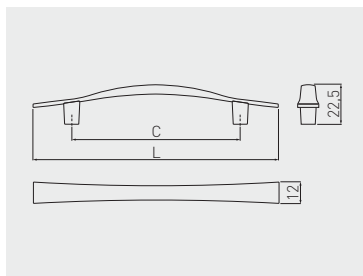

C mm	L mm				
96	140	chrom chrome хром	satyna satin сатин	aluminium aluminium алюминий	ZnAl
		UZ-13-096-01	UZ-13-096-02	UZ-13-096-05	

Uchwyt UZ-14
Handle UZ-14
Ручка UZ-14

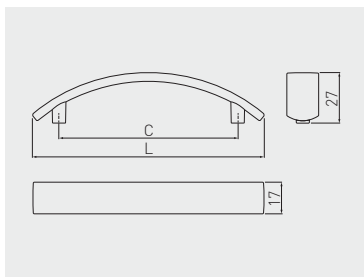

C mm	L mm				
96	138	chrom chrome хром	satyna satin сатин	aluminium aluminium алюминий	ZnAl
128	184	UZ-14-096-01	UZ-14-096-02	UZ-14-096-05	
		UZ-14-128-01	UZ-14-128-02	UZ-14-128-05	

Uchwyt CAMAIO
Handle CAMAIO
Ручка CAMAIO

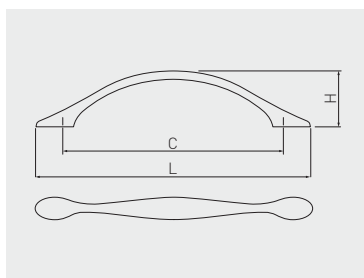

C mm	L mm	H mm					
96	126	23	chrom chrome хром	satyna satin сатин	stal szczotkowana brushed steel шлифованная сталь	antyczny mosiądz szczotkowany antique brushed brass античная шлифованная латунь	
128	160	32,5	UZ-CAMAI-96-01	UZ-CAMAI-96-02	UZ-CAMAI-96-06	UZ-CAMAI-96-09	
			UZ-CAMAI-128-01	UZ-CAMAI-128-02	UZ-CAMAI-128-06	UZ-CAMAI-128-09	

C mm	L mm	H mm					
96	126	23	biały mat white matt белый матовый	czarny mat black matt чёрный матовый	czarny chrom black chrome чёрный хром		ZnAl
128	160	32,5	UZ-CAMAI-96-10M	UZ-CAMAI-96-20M	UZ-CAMAI-96-12		
			UZ-CAMAI-128-10M	UZ-CAMAI-128-20M	UZ-CAMAI-128-12		

Gatka BERGAMO
Knob BERGAMO
Ручка BERGAMO

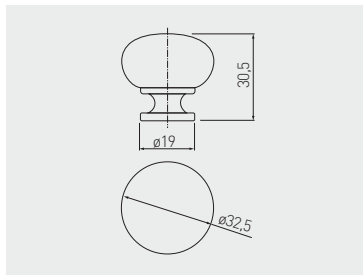

	chrom chrome хром	satyna satin сатин	aluminium aluminium алюминий	stal szczotkowana brushed steel шлифованная сталь	stal steel сталь
gatka knob ручка	GS-BERGA-1-01	GS-BERGA-1-02	GS-BERGA-1-05	GS-BERGA-1-06	



	biały white белый	czarny mat black matt чёрный матовый	czarny chrom black chrome чёрный хром	stal steel сталь
gatka knob ручка	GS-BERGA-1-10	GS-BERGA-1-20M	GS-BERGA-1-12	

Gatka UDINE
Knob UDINE
Ручка UDINE

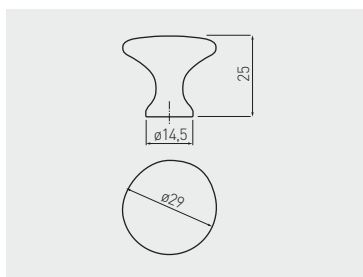

	chrom chrome хром	satyna satin сатин	aluminium aluminium алюминий	stal szczotkowana brushed steel шлифованная сталь	ZnAl
gatka knob ручка	GZ-UDINE-1-01	GZ-UDINE-1-02	GZ-UDINE-1-05	GZ-UDINE-1-06	



	biały mat white matt белый матовый	czarny chrom black chrome чёрный хром	czarny mat black matt чёрный матовый	ZnAl
gatka knob ручка	GZ-UDINE-1-10M	GZ-UDINE-1-12	GZ-UDINE-1-20M	

Gatka TERNI
Knob TERNI
Ручка TERNI

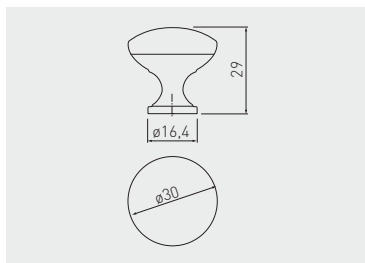

	chrom chrome хром	satyna satin сатин	aluminium aluminium алюминий	stal szcztokowana brushed steel шлифованная сталь	antyczny mosiądz szcztokowany antique brushed brass античная шлифованная латунь
gatka knob ручка	GZ-TERNI-1-01	GZ-TERNI-1-02	GZ-TERNI-1-05	GZ-TERNI-1-06	GZ-TERNI-1-09



	biały white белый	czarny mat black matt чёрный матовый	czarny chrom black chrome чёрный хром	ZnAl
gatka knob ручка	GZ-TERNI-1-10	GZ-TERNI-1-20M	GZ-TERNI-1-12	

Gatka GZ-1155
Knob GZ-1155
Ручка GZ-1155

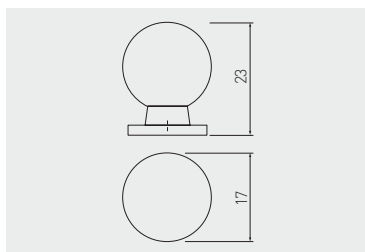

	chrom chrome хром	ZnAl
gatka knob ручка	GZ-WP1155-01	

Gatka GZ-ZH
Knob GZ-ZH
Ручка GZ-ZH

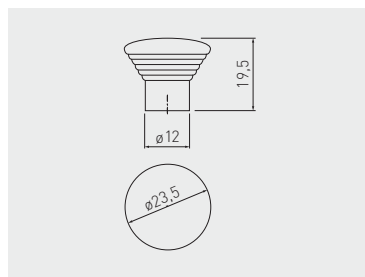

			
	chrom chrome хром	aluminium aluminium алюминий	ZnAl
gatka knob ручка	GZ-ZH-011-01A	GZ-ZH-011-05A	

CLASSIC

Uchwyt TRIEST
Handle TRIEST
Ручка TRIEST

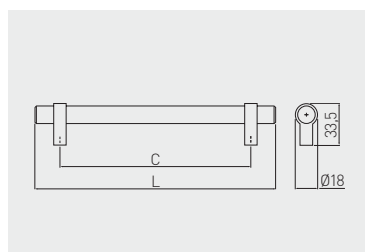

			
		stal szczotkowana brushed steel шлифованная сталь	
96	136	RS-TRIES-96-06	stal, ZnAl steel, ZnAl сталь, ZnAl
128	168	RS-TRIES-128-06	
160	200	RS-TRIES-160-06	
192	232	RS-TRIES-192-06	
256	296	RS-TRIES-256-06	
320	360	RS-TRIES-320-06	

Uchwyt RELING RS
Handle RELING RS
Ручка RELING RS

RAIL

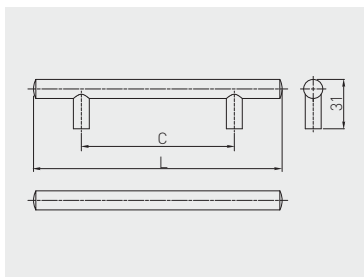

		chrom chrome хром	satyna satin сатин	aluminium aluminium алюминий	stal szorstkowana brushed steel шлифованная сталь	antyczna miedź antique copper античная медь	
96	156	RS-156096-01	RS-156096-02	RS-156096-05	RS-156096-06	RS-156096-14	
128	188	RS-188128-01	RS-188128-02	RS-188128-05	RS-188128-06	RS-188128-14	
160	220	RS-220160-01	RS-220160-02	RS-220160-05	RS-220160-06	RS-220160-14	
192	272	RS-272192-01	RS-272192-02	RS-272192-05	RS-272192-06	RS-272192-14	
224	304	RS-304224-01	RS-304224-02	RS-304224-05	RS-304224-06	RS-304224-14	
256	336	RS-336256-01	RS-336256-02	RS-336256-05	RS-336256-06	RS-336256-14	
288	368	RS-368288-01	RS-368288-02	RS-368288-05	RS-368288-06	-	stal steel сталь
320	400	RS-400320-01	RS-400320-02	RS-400320-05	RS-400320-06	RS-400320-14	
352	432	RS-432352-01	RS-432352-02	RS-432352-05	RS-432352-06	-	
384	464	RS-464384-01	RS-464384-02	RS-464384-05	RS-464384-06	-	
416	496	RS-496416-01	RS-496416-02	RS-496416-05	RS-496416-06	-	
448	528	RS-528448-01	RS-528448-02	RS-528448-05	RS-528448-06	-	
480	560	RS-560480-01	RS-560480-02	RS-560480-05	RS-560480-06	-	
512	592	RS-592512-01	RS-592512-02	RS-592512-05	RS-592512-06	-	
544	624	RS-624544-01	RS-624544-02	RS-624544-05	RS-624544-06	-	

Na indywidualne zamówienie dostępne również rozstawy: 576, 608, 640, 672, 704, 736, 768, 800 [mm].

Other sizes are available for special orders: 576, 608, 640, 672, 704, 736, 768, 800 [mm].

Под заказ доступны ручки с межцентровым расстоянием: 576, 608, 640, 672, 704, 736, 768, 800 [мм]



antyczna miedź
antique copper
античная медь



Uchwyt UA-326
Handle UA-326
Ручка UA-326

RECESSED

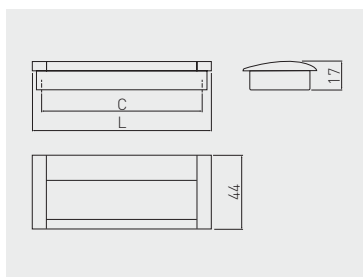

C mm	L mm			
		aluminium / chrom aluminium / chrome алюминий / хром	czarny black чёрный	aluminium aluminium алюминий
96	108	UA-01-326096-V1	UA-00-326096-20M	
128	140	UA-01-326128-V1	UA-00-326128-20M	
160	172	UA-01-326160	UA-00-326160-20M	

Uchwyt UZ-E6
Handle UZ-E6
Ручка UZ-E6

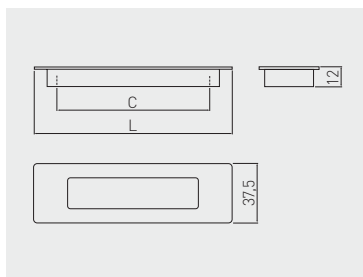

C mm	L mm				
		chrom chrome хром	aluminium aluminium алюминий	stal szczerkowna brushed steel шлифованная сталь	ZnAl
96	124	UZ-E6-096-01	UZ-E6-096-05	UZ-E6-096-06	
128	155	UZ-E6-128-01	UZ-E6-128-05	UZ-E6-128-06	
160	186	UZ-E6-160-01	UZ-E6-160-05	UZ-E6-160-06	

Uchwyt B224
Handle B224
Ручка B224

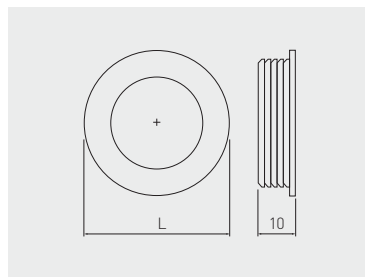

 L mm						
	chrom chrome хром	satyna satin сатин	aluminium aluminium алюминий	biały white белый	czarny black чёрный	ZnAl
40,5	UZ-00B224-01	UZ-00B224-02	UZ-00B224-05	UZ-00B224-10	UZ-00B224-20	



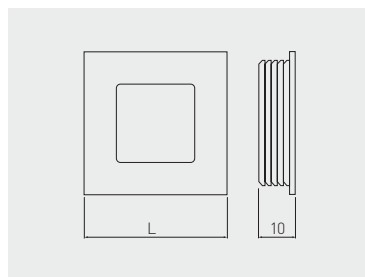

Uchwyt B226
Handle B226
Ручка B226

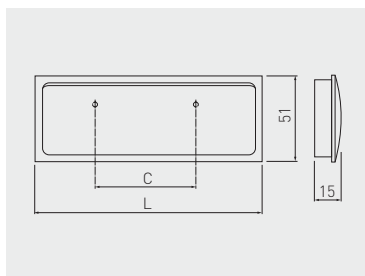

 L mm						
	chrom chrome хром	satyna satin сатин	aluminium aluminium алюминий	biały white белый	czarny black чёрный	ZnAl
40	UZ-00B226-01	UZ-00B226-02	UZ-00B226-05	UZ-00B226-10	UZ-00B226-20	

Uchwyt UZ-R132
Handle UZ-R132
Ручка UZ-R132



 C mm	 L mm			
64	133	chrom chrome хром	satyna satin сатин	
		UZ-R132-A1-01	UZ-R132-A1-02	

Uchwyt UZ-S50
Handle UZ-S50
Ручка UZ-S50

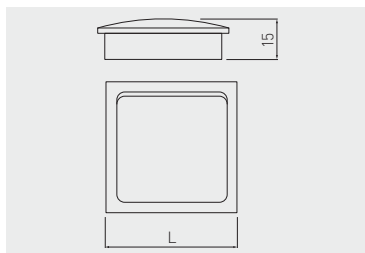

 L mm			
50	chrom chrome хром	stal szcztokowana brushed steel шлифованная сталь	
	UZ-S50-A1-01	UZ-S50-A1-02	UZ-S50-A1-06

Uchwyt HEXI
Handle HEXI
Ручка HEXI

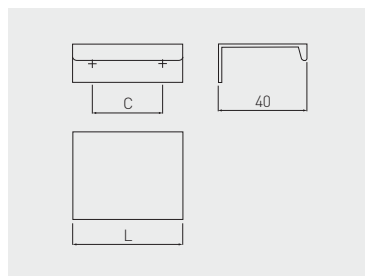

C mm	L mm					
		chrom chrome хром	aluminium aluminium алюминий	biały mat white matt белый матовый	czarny mat black matt чёрный матовый	aluminium aluminium алюминий
32	50	UA-HEXI-01	UA-HEXI-05	UA-HEXI-10M	UA-HEXI-20M	
96	150	UA-HEXI96-01	UA-HEXI96-05	UA-HEXI96-10M	UA-HEXI96-20M	
192	225	UA-HEXI192-01	UA-HEXI192-05	UA-HEXI192-10M	UA-HEXI192-20M	
do cięcia to cut для резки	3500	-	UA-HEXI-3500-05	-	-	



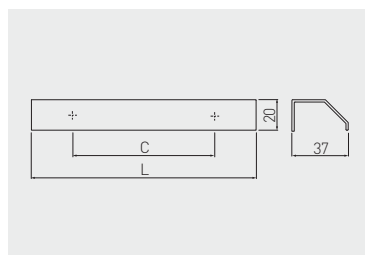

Uchwyt PAXO
Handle PAXO
Ручка PAXO

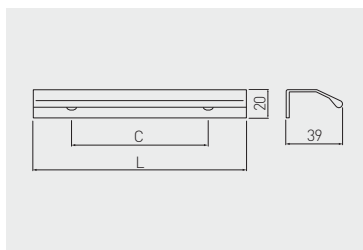

C mm	L mm		
		aluminium aluminium алюминий	aluminium aluminium алюминий
32	50	UA-PAXO-32-50-05	
96	150	UA-PAXO-96-150-05	
224	250	UA-PAXO-224-250-05	
320	350	UA-PAXO-320-350-05	
do cięcia to cut для резки	3500	UA-PAXO-3500-05	

Uchwyt TREX
Handle TREX
Ручка TREX



 C mm	 L mm			
		aluminium aluminium алюминий	czarny mat black matt чёрный матовый	aluminium aluminium алюминий
32	50	UA-TREX-32-50-05	UA-TREX-32-50-20M	
96	150	UA-TREX-96-150-05	UA-TREX-96-150-20M	
224	250	UA-TREX-224-250-05	UA-TREX-224-250-20M	
320	350	UA-TREX-320-350-05	UA-TREX-320-350-20M	
do cięcia to cut для резки	3500	UA-TREX-3500-05	-	



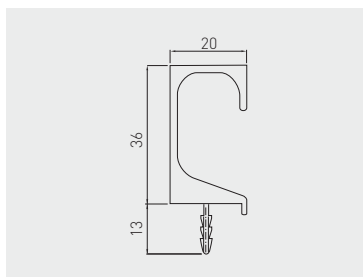

Uchwyt PROFIL C
Handle PROFIL C
Ручка PROFIL C

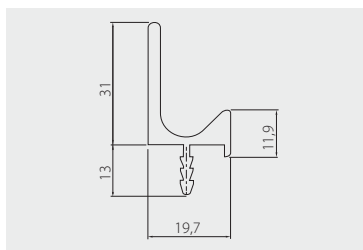

 C mm	 L mm				
		aluminium aluminium алюминий	stal szczotkowana brushed steel шлифованная сталь	czarny mat black matt чёрный матовый	aluminium aluminium алюминий
do cięcia to cut для резки	3500	PA-0242-35-50	PA-0242-35-50-06	PA-0242-35-50-20M	



Uchwyt PROFIL L
Handle PROFIL L
Ручка PROFIL L



 C mm	 L mm		
do cięcia to cut для резки	3500	aluminium aluminium алюминий	stal szorstkowana brushed steel шлифованная сталь
		PA-0243-35-50	czarny mat black matt чёрный матовый
		PA-0243-35-50-06	PA-0243-35-50-20M
			aluminium aluminium алюминий

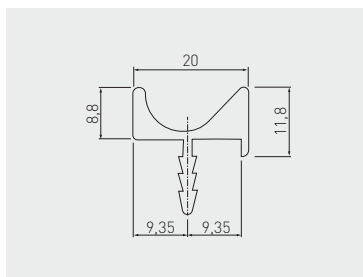



Uchwyt PROFIL U
Handle PROFIL U
Ручка PROFIL U

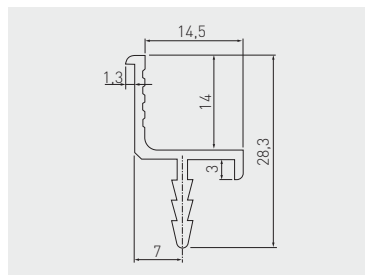

 C mm	 L mm		
do cięcia to cut для резки	3500	aluminium aluminium алюминий	aluminium aluminium алюминий
		PA-0244-35-50	





Uchwyt PROFIL J
Handle PROFIL J
Ручка PROFIL J

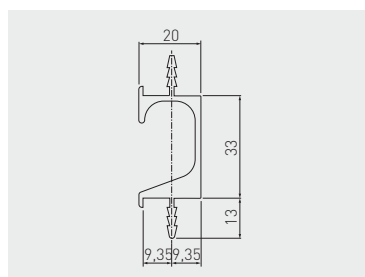

 C mm	 L mm		
		aluminium aluminium алюминий	aluminium aluminium алюминий
do cięcia to cut для резки	3500	PA-0245-35-50	

Uchwyt PROFIL C2
Handle PROFIL C2
Ручка PROFIL C2



 C mm	 L mm		
		aluminium aluminium алюминий	aluminium aluminium алюминий
do cięcia to cut для резки	3500	PA-0241-35-50	

Uchwyt PICADO
Handle PICADO
Ручка PICADO

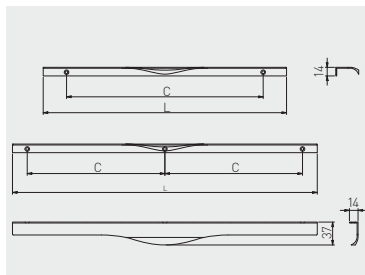

C
mm

L
mm



C	L	chrom chrome хром	aluminium aluminium алюминий	czarny mat black matt чёрный матовый	
256	296	UA-PICADO-256-296-01	UA-PICADO-256-296-05	UA-PICADO-256-296-20M	aluminium aluminium алюминий
320	396	UA-PICADO-320-396-01	UA-PICADO-320-396-05	UA-PICADO-320-396-20M	
2 x 224*	496	UA-PICADO-224-496-01	UA-PICADO-224-496-05	UA-PICADO-224-496-20M	
2 x 256*	596	UA-PICADO-256-596-01	UA-PICADO-256-596-05	UA-PICADO-256-596-20M	
2 x 352*	796	UA-PICADO-352-796-01	UA-PICADO-352-796-05	UA-PICADO-352-796-20M	

* Mocowanie na 3 wkręty / Mounted with 3 screws / Крепление на 3 самореза



Gatka J4
Knob J4
Ручка J4

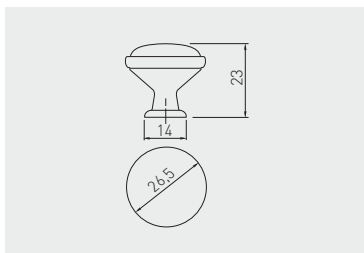

motyw pattern рисунок	antyczny mosiądz antique brass античная латунь	antyczne srebro antique silver старинное серебро	
autumn rose	GP-0728-J4-B	-	ZnAl, porcelana ZnAl, porcelain ZnAl, фарфор
spring flower	GP-0728-J4-R	-	
blue rose	GP-0728-J4-A-04	GP-0728-J4-A-07	
orient gold	GP-0728-J4-C-04	-	



autumn rose

spring flower

blue rose

orient gold

Uchwyt 728B
Handle 728B
Ручка 728B

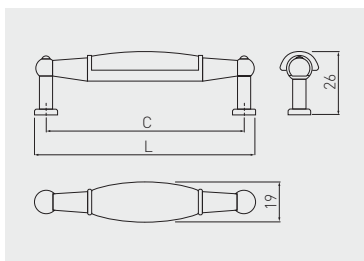

motyw pattern рисунок	C mm	L mm	antyczny mosiądz antique brass античная латунь	
spring flower	96	106	UP-WP0728-BR	ZnAl, porcelana ZnAl, porcelain ZnAl, фарфор
country	96	106	UP-WP0728-BK	
ornament	96	106	UP-WP0728-BX	
autumn rose	96	106	UP-WP0728-BB	



spring flower

country

ornament

autumn rose

Uchwyt 728P
Handle 728P
Ручка 728P

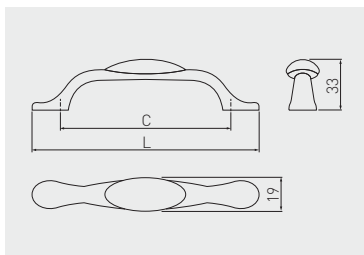

	 C mm	 L mm			
motyw pattern рисунок			antyczny mosiądz antique brass античная латунь	antyczne srebro antique silver старинное серебро	ZnAl, porcelana ZnAl, porcelain ZnAl, фарфор
blue rose	96	125	UP-WP0728-PA-04	UP-WP0728-PA-07	
orient gold	96	125	UP-WP0728-PC-04	-	
ornament	96	125	UP-WP0728-PX	-	
autumn rose	96	125	UP-WP0728-PB	-	
spring flower	96	125	UP-WP0728-PR	-	
country	96	125	UP-WP0728-PK	-	
milky	96	125	UP-WP0728-P0	-	



blue rose



orient gold



ornament



autumn rose



spring flower



country



milky

Uchwyt ALATRI
Handle ALATRI
Ручка ALATRI

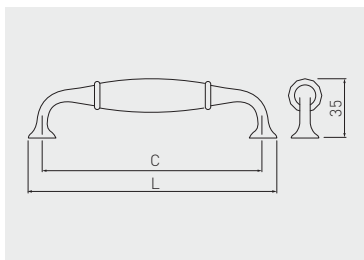

 C mm	 L mm		
128	144	antyczny mosiądz antique brass античная латунь	ZnAl, porcelana ZnAl, porcelain ZnAl, фарфор
		UZ-ALATR-128-04	



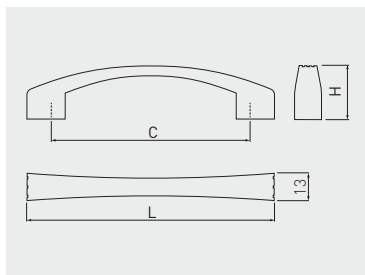



Uchwyt VASTO
Handle VASTO
Ручка VASTO

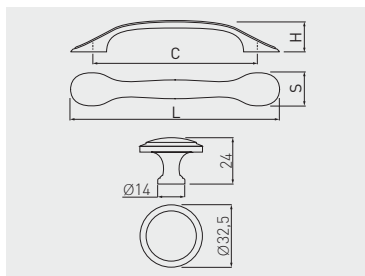

 C mm	 L mm	 H mm		
			antyczny mosiądz szczotkowany antique brushed brass античная шлифованная латунь	ZnAl
96	120	26	UZ-VASTO-96-09	
128	151	27	UZ-VASTO-128-09	





Uchwyt PALERMO
Handle PALERMO
Ручка PALERMO

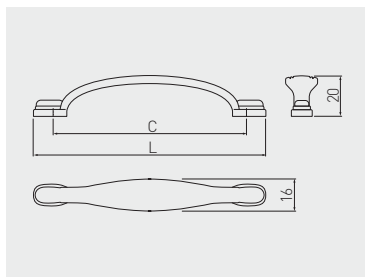

 C mm	 L mm	 H mm	 S mm		
				antyczne srebro antique silver античное серебро	ZnAl
96	127	22,5	23	UZ-PALER-96-07	
128	159	23	25	UZ-PALER-128-07	
gatka knob ручка	-	-	-	GZ-PALER-1-07	

Uchwyt UZ-10
Handle UZ-10
Ручка UZ-10



 C mm	 L mm		
		antyczny mosiądz antique brass античная латунь	ZnAl
96	120	UZ-10-096-N04	

Uchwyt UZ-12
Handle UZ-12
Ручка UZ-12

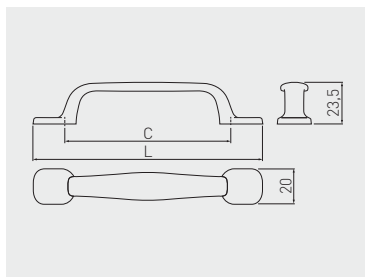

 C mm	 L mm				
		antyczny mosiądz antique brass античная латунь	antyczne srebro antique silver античное серебро	czarny mat black matt чёрный матовый	ZnAl
96	131	UZ-12-096-04N	UZ-12-096-07	UZ-12-096-20M	

Uchwyt WERONA
Handle WERONA
Ручка WERONA

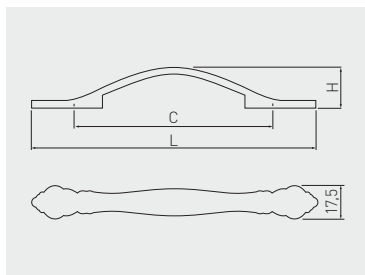

C mm	L mm	H mm				
			antyczny mosiądz antique brass античная латунь	antyczny mosiądz szczotkowany antique brushed brass античная шлифованная латунь	czarny chrom black chrome чёрный хром	ZnAl
96	148	24,5	UZ-WERON-96-04	UZ-WERON-96-09	UZ-WERON-96-12	
128	183	26,5	UZ-WERON-128-04	UZ-WERON-128-09	UZ-WERON-128-12	

Gałka ARDEA
Knob ARDEA
Ручка ARDEA

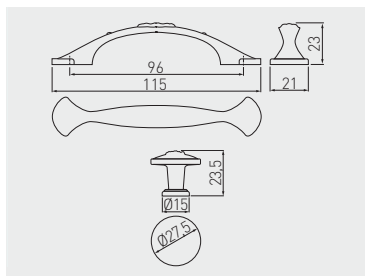

C mm	L mm		
		antyczny mosiądz antique brass античная латунь	ZnAl
96	115	UZ-ARDEA-96-09	
gałka knob ручка	-	GZ-ARDEA-1-09	



Uchwyt VINCENZA
Handle VINCENZA
Ручка VINCENZA

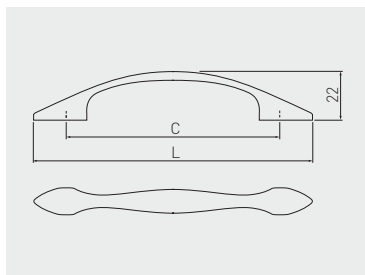

 C mm	 L mm		
		antyczny mosiądz antique brass античная латунь	ZnAl
96	125	UZ-VINCE-96-04	

Uchwyt APRILLA
Handle APRILLA
Ручка APRILLA

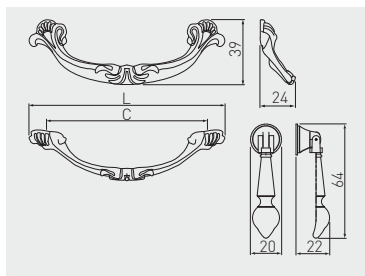

 C mm	 L mm		
		antyczny mosiądz antique brass античная латунь	ZnAl
96	122	UZ-APRIL-96-04	
kotatka knocker ручка		KT-APRIL-1-04	

Uchwyt AVELI
Handle AVELI
Ручка AVELI

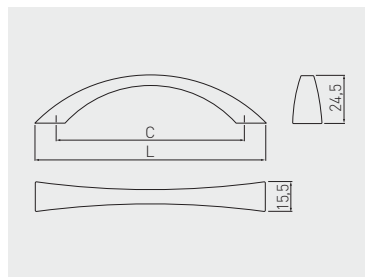

C mm	L mm		
		antyczny mosiądz antique brass античная латунь	ZnAl
96	118	UZ-AVELI-96-04	

Uchwyt ARCHE*
Handle ARCHE*
Ручка ARCHE*

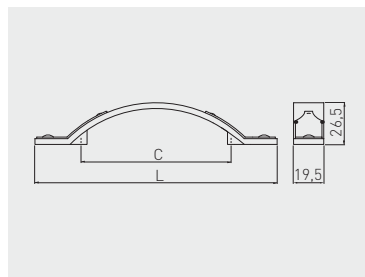

C mm	L mm		
		antyczny mosiądz szorstkowany antique brushed brass античная шлифованная латунь	ZnAl
96	155	UZ-ARCH096-AEB	

* Produkt dostępny na indywidualne zamówienie / Available for special orders / Товар доступен под заказ

Uchwyt AREZO
Handle AREZO
Ручка AREZO

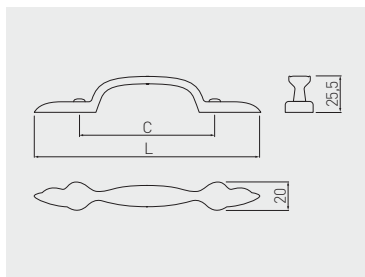

C mm	L mm		
		antyczny mosiądz antique brass античная латунь	ZnAl
96	160	UZ-AREZO-96-04	

Uchwyt ABIATE
Handle ABIATE
Ручка ABIATE

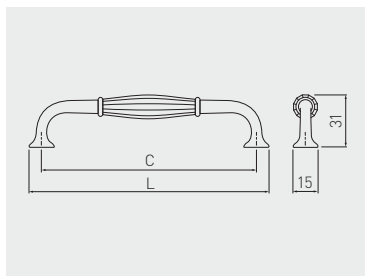

C mm	L mm		
		antyczny mosiądz antique brass античная латунь	ZnAl
128	143	UZ-ABIAT-128-04	

Uchwyt ADRIN
Handle ADRIN
Ручка ADRIN

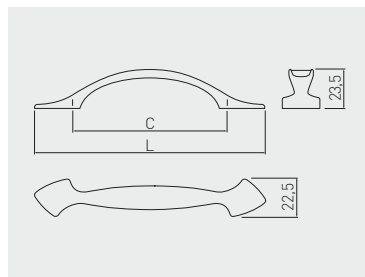

C mm	L mm		
		antyczny mosiądz antique brass античная латунь	ZnAl
96	139	UZ-ADRIN-96-04	



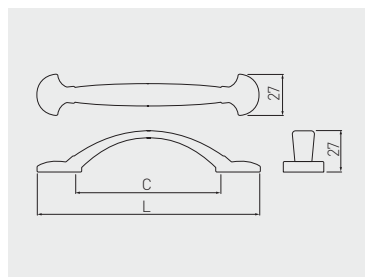

Uchwyt ACERA
Handle ACERA
Ручка ACERA

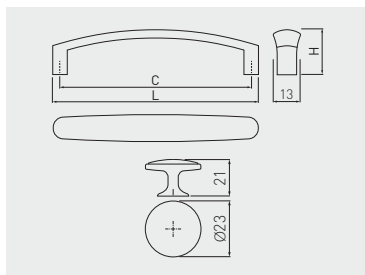

C mm	L mm		
		antyczny mosiądz antique brass античная латунь	ZnAl
96	147	UZ-ACERA-96-04	

Uchwyt OLBIA
Handle OLBIA
Ручка OLBIA



 C mm	 L mm	 H mm		
96	103	22	antyczny mosiądz antique brass античная латунь	ZnAl
128	136	24	UZ-OLBIA-96-04	
gatka knob ручка	-	-	UZ-OLBIA-128-04	
			GZ-OLBIA-1-04	

Uchwyt LATINA
Handle LATINA
Ручка LATINA

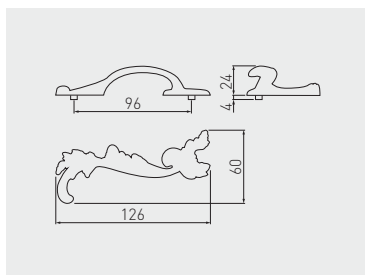

 C mm		
96	antyczny mosiądz antique brass античная латунь	ZnAl
	UZ-LATIN-96-04	

Uchwyt ANZIO
Handle ANZIO
Ручка ANZIO

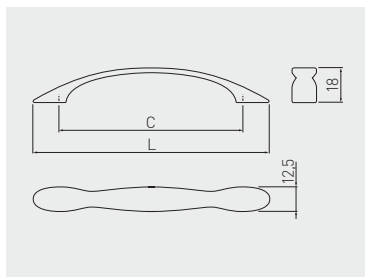

C mm	L mm		
		antyczny mosiądz antique brass античная латунь	ZnAl
96	123	UZ-ANZIO-96-04	

Uchwyt AZTEK
Handle AZTEK
Ручка AZTEK

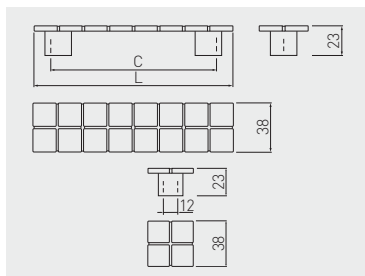

C mm	L mm		
		antyczny mosiądz antique brass античная латунь	ZnAl
128	155	UZ-AZ-128-04	
160	194	UZ-AZ-160-04	
gałka knob ручка	38	UZ-AZ-012-04	

Uchwyt MARSALA
Handle MARSALA
Ручка MARSALA

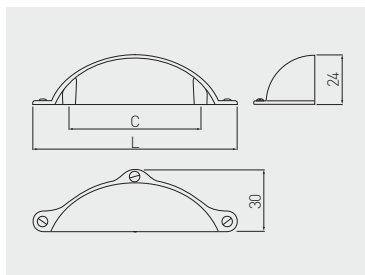

C mm	L mm				
64	99,5	antyczne srebro antique silver античное серебро	antyczny mosiądz szcztokowany antique brushed brass античная шлифованная латунь	biały mat white matt белый матовый	ZnAl
		UZ-MARSA-64-07	UZ-MARSA-64-09	UZ-MARSA-64-10M	

C mm	L mm			
64	99,5	tytan szcztokowany brushed titanium шлифованный титан	czarny mat black matt чёрный матовый	ZnAl
		UZ-MARSA-64-11	UZ-MARSA-64-20M	



Uchwyt ROYAL
Handle ROYAL
Ручка ROYAL

GZ-ROYAL3-1-10-03



UZ-ROYAL4-96-03



UZ-ROYAL1-96-10-03



UZ-ROYAL2-96-10-03



UZ-ROYAL3-96-10-03



UZ-ROYAL5-128-10-03

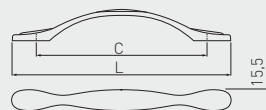
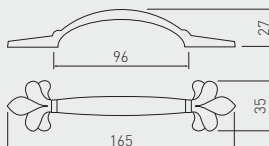
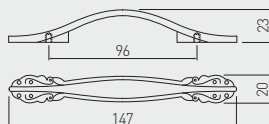
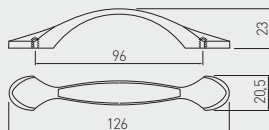
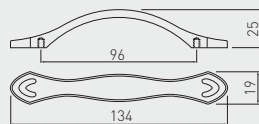
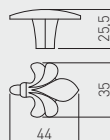

motyw pattern рисунк	C mm	L mm	biały, złoty white, gold белый, золото	
latina	96	126	UZ-ROYAL1-96-10-03	ZnAl
werona	96	147	UZ-ROYAL2-96-10-03	
genova	96	165	UZ-ROYAL3-96-10-03	
reggio	96	134	UZ-ROYAL4-96-03	
piano	96	131	UZ-ROYAL5-96-10-03	
	128	164	UZ-ROYAL5-128-10-03	
genova	gatka knob ручка	35	GZ-ROYAL3-1-10-03	

Gatka UZ-WP146
Knob UZ-WP146
Ручка UZ-WP146

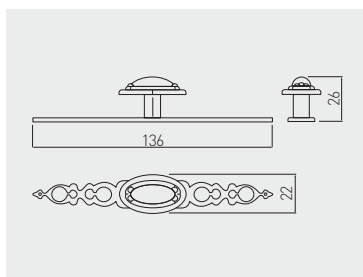

		
	antyczny mosiądz antique brass античная латунь	ZnAl
gatka knob ручка	UZ-WP146-04	

Gatka GZ-1136
Knob GZ-1136
Ручка GZ-1136

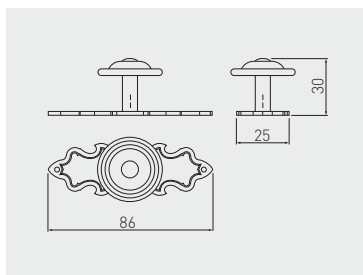

		
	antyczny mosiądz antique brass античная латунь	ZnAl
gatka knob ручка	GZ-WP1136-04	

Gatka GZ-1148
Knob GZ-1148
Ручка GZ-1148

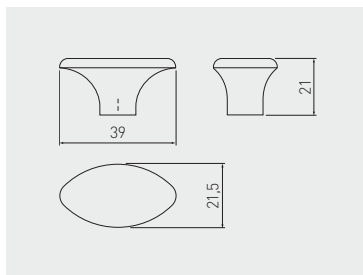

		
	antyczny mosiądz antique brass античная латунь	ZnAl
gatka knob ручка	GZ-WP1148-04	

Gatka GZ-1152*
Knob GZ-1152*
Ручка GZ-1152*

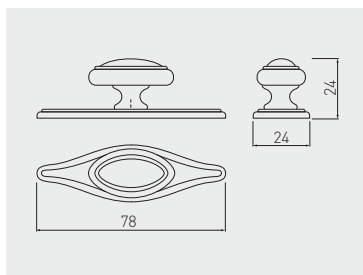





		
	antyczny mosiądz antique brass античная латунь	ZnAl
gatka knob ручка	GZ-WP1152-04	

* Produkt dostępny na indywidualne zamówienie / Available for special orders / Товар доступен под заказ

Uchwyt RENNES
Handle RENNES
Ручка RENNES



 C mm	 L mm		
96	121	antyczny mosiądz antique brass античная латунь	ZnAl
kołatka knocker ручка		UZ-RENG02-04A	
gátka knob ручка		UZ-RENG01-04A	

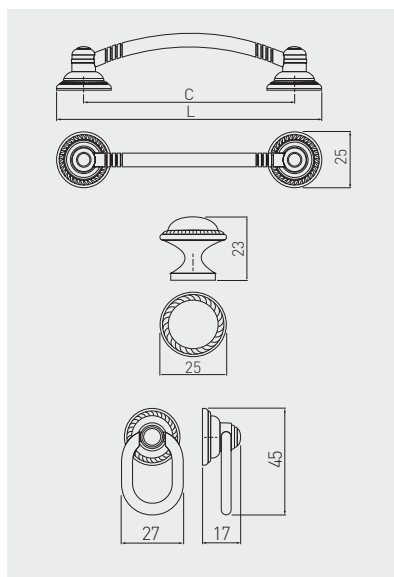

Kołatka KT-1147
Knocker KT-1147
Ручка KT-1147

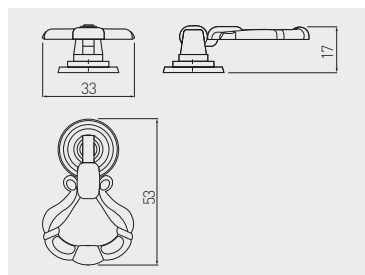

		
	antyczny mosiądz antique brass античная латунь	ZnAl
kołatka knocker ручка	KT-WP1147-04	

Gałka FROSINO
Knob FROSINO
Ручка FROSINO

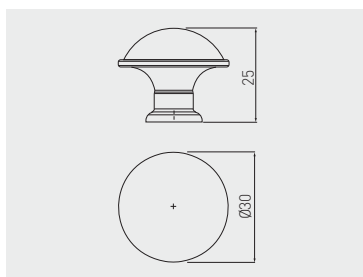

	antyczny mosiądz antique brass античная латунь	antyczny mosiądz szorstkowany antique brushed brass античная шлифованная латунь	ZnAl
gałka knob ручка	GZ-FROSI-1-04	GZ-FROSI-1-09	

Gałka CENTO
Knob CENTO
Ручка CENTO

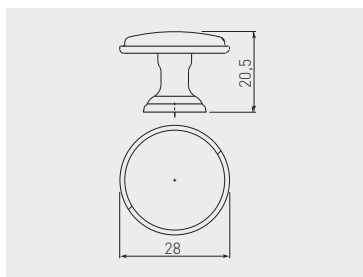

	antyczny mosiądz antique brass античная латунь	antyczne srebro antique silver античное серебро	antyczna miedź antique copper античная медь	czarny mat black matt чёрный матовый	ZnAl
gałka knob ручка	GZ-CENTO-1-04	GZ-CENTO-1-07	GZ-CENTO-1-14	GZ-CENTO-1-20M	

Gatka IMPERIA
Knob IMPERIA
Ручка IMPERIA

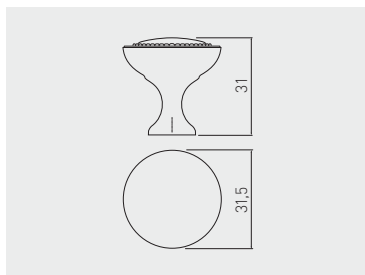

	satyna satin сатин	tytan szczotkowany brushed titanium шлифованный титан	czarny mat black matt чёрный матовый	aluminium aluminium алюминий
gatka knob ручка	GA-IMPER-1-02B	GA-IMPER-1-11	GA-IMPER-1-20M	

Uchwyt UZ-71C
Handle UZ-71C
Ручка UZ-71C

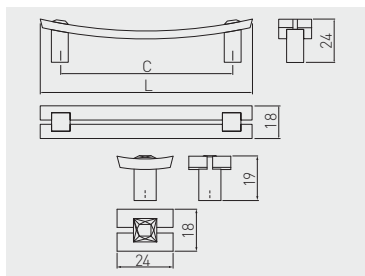

C
mm





L
mm

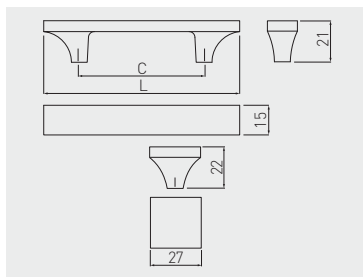

		chrom chrome хром	ZnAl, szkło ZnAl, glass ZnAl, стекло
96	118	UZ-71C096-01	
gatka knob ручка		GZ-71C024-01	





Uchwyt UZ-02C
Handle UZ-02C
Ручка UZ-02C

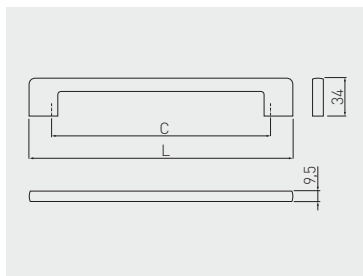

 C mm	 L mm		
		chrom chrome хром	ZnAl, szkło ZnAl, glass ZnAl, стекло
64	99	UZ-02C064-01	
96	135	UZ-02C096-01	
gatka knob ручка	27	UZ-02CF27-01	

Uchwyt UZ-CRA14*
Handle UZ-CRA14*
Ручка UZ-CRA14*





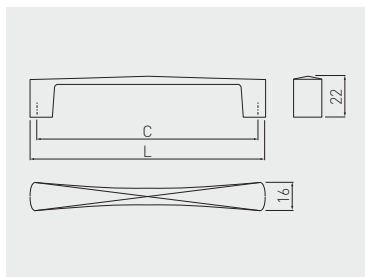

 C mm	 L mm		
		chrom chrome хром	ZnAl
128	166	UZ-CRA14-128	
192	230	UZ-CRA14-192	
320	358	UZ-CRA14-320	

* Produkt dostępny na indywidualne zamówienie / Available for special orders / Товар доступен под заказ







Uchwyt COMO
Handle COMO
Ручка COMO

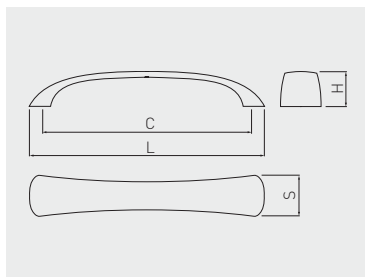

 C mm	 L mm		
		chrom chrome хром	ZnAl
96	104	UZ-COM0096-01	
128	135	UZ-COM0128-01	
160	170	UZ-COM0160-01	

Uchwyt SIENNA
Handle SIENNA
Ручка SIENNA



 C mm	 L mm	 H mm	 S mm		
				chrom chrome хром	ZnAl
96	111	21	23,5	UZ-SIENNA096-01	
128	142	23	25	UZ-SIENNA128-01	
160	186	24,5	26,5	UZ-SIENNA160-01	

Uchwyt LUCCA
Handle LUCCA
Ручка LUCCA

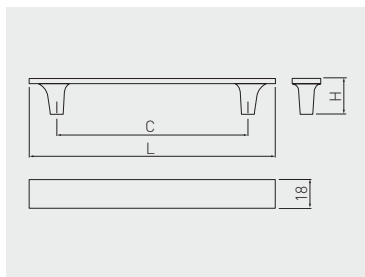

C mm	L mm	H mm		
			chrom chrome хром	ZnAl
96	131	22,5	UZ-LUCCA096-01	
128	163	23	UZ-LUCCA128-01	
160	196	23	UZ-LUCCA160-01	
192	228	23,5	UZ-LUCCA192-01	
224	260	23,5	UZ-LUCCA224-01	



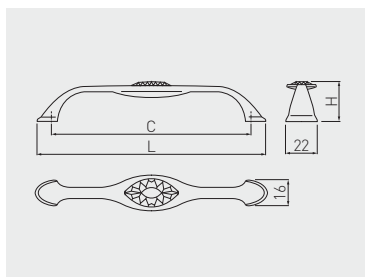

Uchwyt BIANCA
Handle BIANCA
Ручка BIANCA

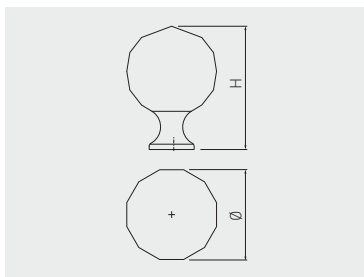

C mm	L mm	H mm		
			chrom chrome хром	ZnAl
96	114	25	UZ-BIANC-96-01	
128	146	26	UZ-BIANC-128-01	

Gatka GZ-CRPA
Knob GZ-CRPA
Ручка GZ-CRPA



 mm	 mm				
		chrom, biały kryształ chrome, white crystal хром, белый кристалл	chrom, czarny kryształ chrome, black crystal хром, чёрный кристалл	mosiądz, biały kryształ brass, white crystal латунь, белый кристалл	ZnAl, szkło ZnAl, glass ZnAl, стекло
20	33	GZ-CRPA20-01	-	-	
25	37	GZ-CRPA25-01	-	-	
30	44	GZ-CRPA30-01	GZ-CRPA30-A1	GZ-CRPA30-03	
40	55	GZ-CRPA40-01	-	-	

Gatka GZ-CRPB
Knob GZ-CRPB
Ручка GZ-CRPB

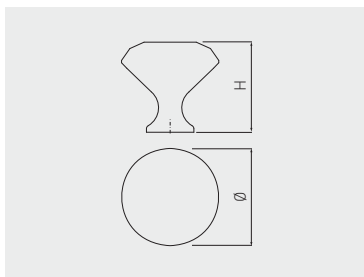

 mm	 mm				
		chrom, biały kryształ chrome, white crystal хром, белый кристалл	chrom, czarny kryształ chrome, black crystal хром, чёрный кристалл	mosiądz, biały kryształ brass, white crystal латунь, белый кристалл	ZnAl, szkło ZnAl, glass ZnAl, стекло
20	26	GZ-CRPB20-01	-	-	
25	28	GZ-CRPB25-01	GZ-CRPB25-A1	-	
30	30	GZ-CRPB30-01	GZ-CRPB30-A1	GZ-CRPB30-03	
40	38	GZ-CRPB40-01	GZ-CRPB40-A1	-	

Gatka GZ-CRPC
 Knob GZ-CRPC
 Ручка GZ-CRPC

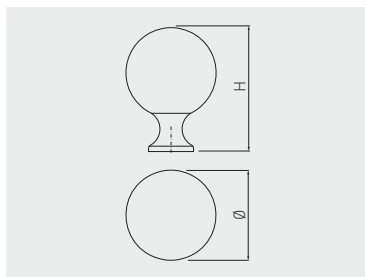

		chrom, biały kryształ chrome, black crystal хром, белый кристалл	chrom, czarny kryształ chrome, black crystal хром, чёрный кристалл	ZnAl, szkło ZnAl, glass ZnAl, стекло
30	43	GZ-CRPC30-01	GZ-CRPC30-A1	



Uchwyt KID
Handle KID
Ручка KID



BLOCK



CLOUD



STAR



BUTTON



FLAMING



HEART



CROWN



TWITT

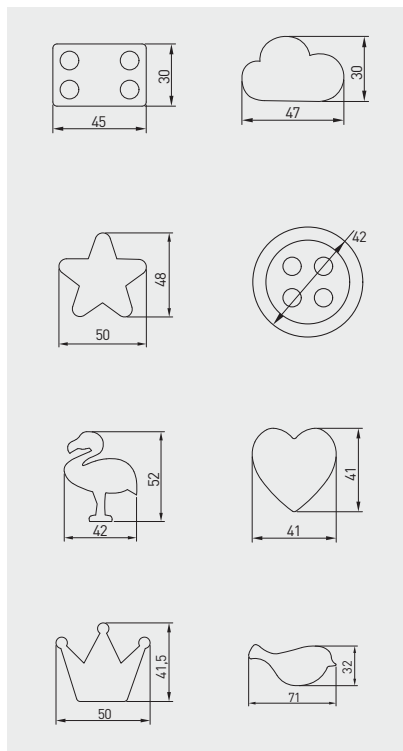

	zielony green зеленый	niebieski blue синий	czerwony red красный	szary grey серый	żółty yellow желтый	różowy pink розовый	
block	UM-BLOCK-ZL	UM-BLOCK-NB	UM-BLOCK-CZ	-	-	-	guma, ZnAl rubber, ZnAl резина, ZnAl
cloud	-	UM-CLOUD-NB	-	UM-CLOUD-SZ	-	-	
star	-	UM-STAR-NB	-	-	UM-STAR-ZT	UM-STAR-RZ	
button	-	UM-BUTTON-NB	-	UM-BUTTON-SZ	-	-	
flaming	-	-	-	UM-FLAMING-SZ	-	UM-FLAMING-RZ	
heart	-	-	-	-	-	UM-HEART-RZ	
crown	-	-	-	-	-	UM-CROWN-RZ	
twitt	UM-TWITT-ZL	-	-	UM-TWITT-SZ	-	-	



Uchwyt KID WILD
Handle KID WILD
Ручка KID WILD



UM-KID-I-002



UM-KID-P-001



UM-KID-Q-001



UM-KID-S-001



UM-KID-U-001



UM-KID-Y-001



tygrys / tiger / тигр	UM-KID-I-002	guma, ZnAl rubber, ZnAl резина, ZnAl
stoń / elephant / слон	UM-KID-P-001	
krokodyl / crocodile / крокодил	UM-KID-Q-001	
hipopotam / hippo / бегемот	UM-KID-S-001	
panda / panda / панда	UM-KID-U-001	
pingwin / penguin / пингвин	UM-KID-Y-001	

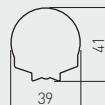
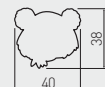
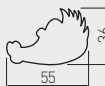

Uchwyt KID PLAY
Handle KID PLAY
Ручка KID PLAY



UM-KID-C-001



UM-KID-D-001



UM-KID-E-001



kwiatek / flower / цветок	UM-KID-C-001	guma, ZnAl rubber, ZnAl резина, ZnAl
samochód / car / автомобиль	UM-KID-D-001	
piłka / ball / мяч	UM-KID-E-001	



Uchwyt KID FARM
Handle KID FARM
Ручка KID FARM



UM-KID-W-001



UM-KID-X-001



UM-KID-Z-001



UM-UNICORN-RZ



konik / horse / лошадь	UM-KID-W-001	guma, ZnAl rubber, ZnAl резина, ZnAl
królik / rabbit / кролик	UM-KID-X-001	
piesek / dog / собака	UM-KID-Z-001	
jednorożec / unicorn / единорог	UM-UNICORN-RZ	



Wieszak SOLO
Hook SOLO
Крючок SOLO

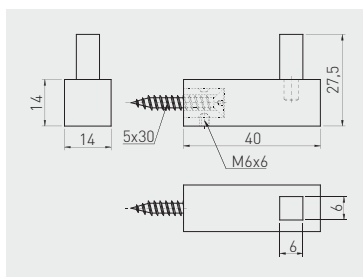

WS-SOLO-14-06



stal szczotkowana / brushed steel / шлифованная сталь



stal / steel / сталь

Wieszak QUADRO*
Hook QUADRO*
Крючок QUADRO*

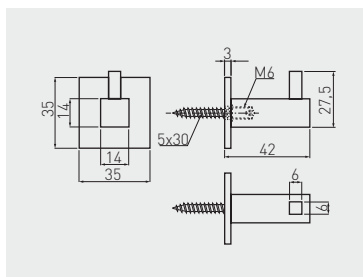

WS-QUAD-14-06



stal szczotkowana / brushed steel / шлифованная сталь



stal / steel / сталь

*Dostępny na zamówienie / Available only for individual order / Доступен под заказ

Wieszak RONDO*
Hook RONDO*
Крючок RONDO*

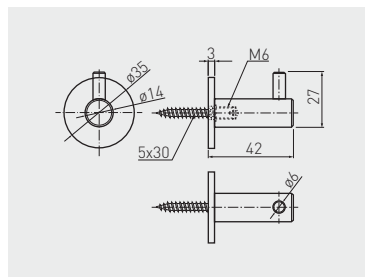



		
WS-ROND-14-06	stal szorstkowana / brushed steel / шлифованная сталь	stal / steel / сталь

*Dostępny na zamówienie / Available only for individual order / Доступен под заказ

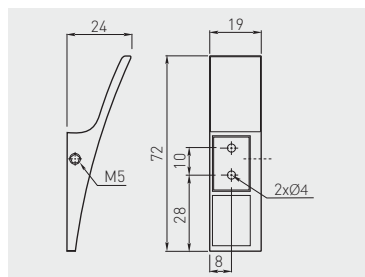
Wieszak 804
Hook 804
Крючок 804



		
WZ-804-20-01	chrom / chrome / хром	ZnAl
WZ-804-20-05	aluminium / aluminium / алюминий	
WZ-804-20-06	stal szorstkowana / brushed steel / шлифованная сталь	

Wieszak TOLEDO A0
Hook TOLEDO A0
Крючок TOLEDO A0

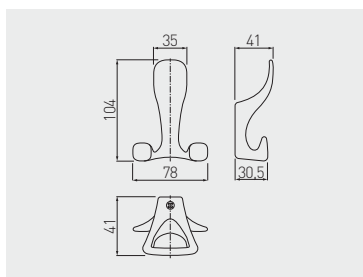

WZ-TOLED-A0-01	chrom / chrome / хром	ZnAl
WZ-TOLED-A0-02	satyna / satin / сатин	
WZ-TOLED-A0-05	aluminium / aluminium / алюминий	
WZ-TOLED-A0-06	stal szczotkowana / brushed steel / шлифованная сталь	
WZ-TOLED-A0-20M	czarny mat / black matt / чёрный матовый	

Wieszak TOLEDO B0
Hook TOLEDO B0
Крючок TOLEDO B0

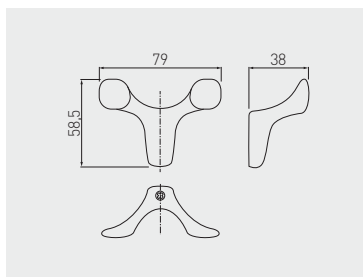

WZ-TOLED-B0-01	chrom / chrome / хром	ZnAl
WZ-TOLED-B0-02	satyna / satin / сатин	
WZ-TOLED-B0-05	aluminium / aluminium / алюминий	
WZ-TOLED-B0-06	stal szczotkowana / brushed steel / шлифованная сталь	
WZ-TOLED-B0-20M	czarny mat / black matt / чёрный матовый	

Wieszak TOLEDO C0
 Hook TOLEDO C0
 Крючок TOLEDO C0

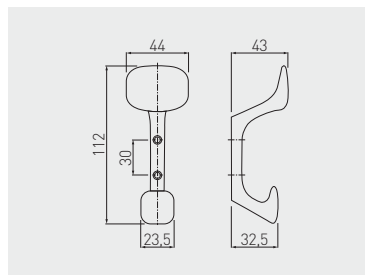

WZ-TOLED-C0-01	chrom / chrome / хром	ZnAl
WZ-TOLED-C0-02	satyna / satin / сатин	
WZ-TOLED-C0-05	aluminium / aluminium / алюминий	
WZ-TOLED-C0-06	stal szczotkowana / brushed steel / шлифованная сталь	
WZ-TOLED-C0-20M	czarny mat / black matt / чёрный матовый	

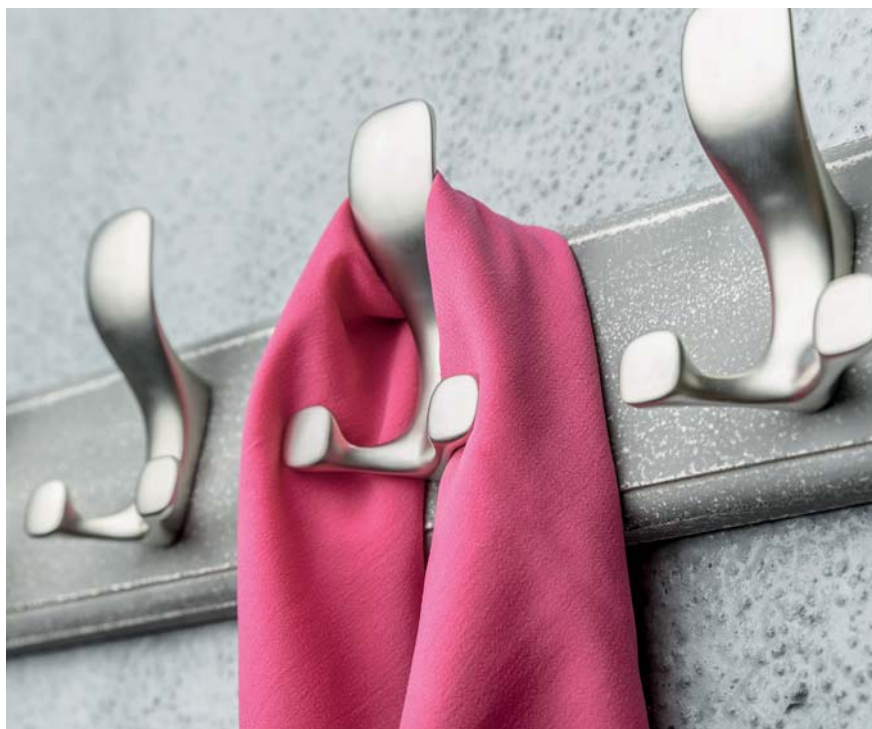

Wieszak WALENCIA
Hook WALENCIA
Крючок WALENCIA

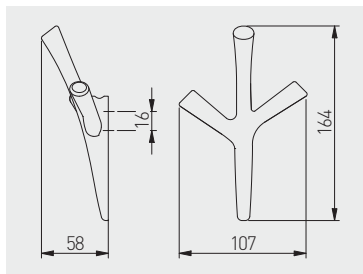

WZ-WALENCIA-01	chrom / chrome / хром	ZnAl
WZ-WALENCIA-06	stal szczotkowana / brushed steel / шлифованная сталь	
WZ-WALENCIA-20M	czarny mat / black matt / чёрный матовый	

Wieszak CORDOBA
Hook CORDOBA
Крючок CORDOBA

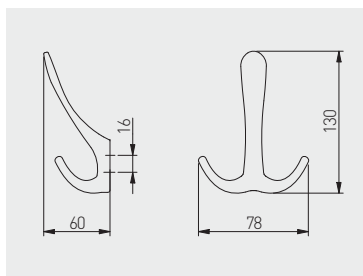

WZ-CORDOBA-01	chrom / chrome / хром	ZnAl
WZ-CORDOBA-06	stal szczotkowana / brushed steel / шлифованная сталь	
WZ-CORDOBA-20M	czarny mat / black matt / чёрный матовый	

Wieszak K2201
Hook K2201
Крючок K2201

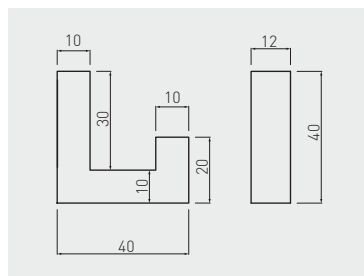

WZ-K2201-01	chrom / chrome / хром	ZnAl
WZ-K2201-06	stal szczotkowana / brushed steel / шлифованная сталь	
WZ-K2201-CZ	czarny / black / чёрный	
WZ-K2201-ZL	zielony / green / зелёный	
WZ-K2201-NB	niebieski / blue / синий	
WZ-K2201-PM	pomarańczowy / orange / оранжевый	
WZ-K2201-RZ	różowy / pink / розовый	
WZ-K2201-CS	kremowy / creamy / кремовый	

Wieszak K2202
Hook K2202
Крючок K2202

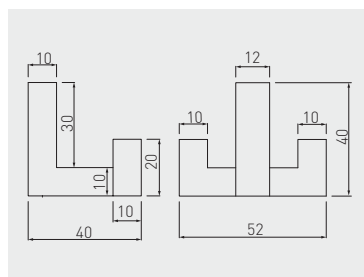

WZ-K2202-01	chrom / chrome / хром	ZnAl
WZ-K2202-06	stal szczotkowana / brushed steel / шлифованная сталь	
WZ-K2202-CZ	czarny / black / чёрный	
WZ-K2202-PM	pomarańczowy / orange / оранжевый	
WZ-K2202-RZ	różowy / pink / розовый	
WZ-K2202-CS	kremowy / creamy / кремовый	

Wieszak K23-A0
Hook K23-A0
Крючок K23-A0

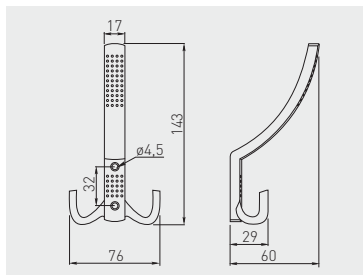

WZ-A0-K23-01	chrom / chrome / хром	ZnAl
WZ-A0-K23-02	satyna / satin / сатин	
WZ-A0-K23-03	mosiądz / brass / латунь	
WZ-A0-K23-04	antyczny mosiądz / antique brass / античная латунь	
WZ-A0-K23-05	aluminium / aluminium / алюминий	
WZ-A0-K23-06*	stal szczerkowana / brushed steel / шлифованная сталь	
WZ-A0-K23-07	antyczne srebro / antique silver / античное серебро	
WZ-A0-K23-20	czarny mat / black matt / чёрный матовый	

*Dostępny na zamówienie / Available only for individual order / Доступен под заказ

Wieszak K23-B0
Hook K23-B0
Крючок K23-B0

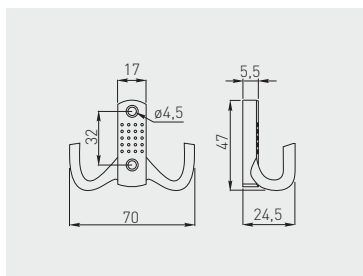

WZ-B0-K23-01	chrom / chrome / хром	ZnAl
WZ-B0-K23-02	satyna / satin / сатин	
WZ-B0-K23-03	mosiądz / brass / латунь	
WZ-B0-K23-04	antyczny mosiądz / antique brass / античная латунь	
WZ-B0-K23-05	aluminium / aluminium / алюминий	
WZ-B0-K23-06*	stal szczerkowana / brushed steel / шлифованная сталь	
WZ-B0-K23-07	antyczne srebro / antique silver / античное серебро	
WZ-B0-K23-20	czarny mat / black matt / чёрный матовый	

*Dostępny na zamówienie / Available only for individual order / Доступен под заказ

Wieszak K23-D1*
Hook K23-D1*
Крючок K23-D1*

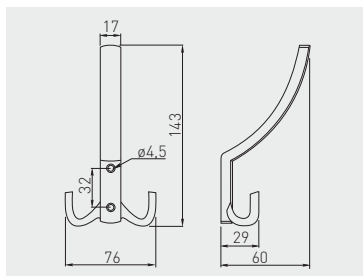

WZ-K23-D1-01	chrom / chrome / хром	ZnAl
WZ-K23-D1-02	satyna / satin / сатин	
WZ-K23-D1-03	mosiądz / brass / латунь	
WZ-K23-D1-05	aluminium / aluminium / алюминий	
WZ-K23-D1-06	stal szczotkowana / brushed steel / шлифованная сталь	

*Dostępny na zamówienie / Available only for individual order / Доступен под заказ

Wieszak K23-E1*
Hook K23-E1*
Крючок K23-E1*

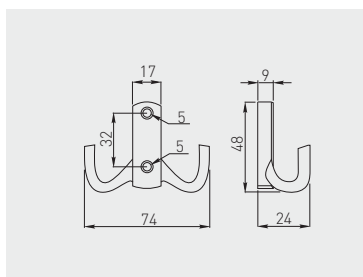

WZ-K23-E1-01	chrom / chrome / хром	ZnAl
WZ-K23-E1-02	satyna / satin / сатин	
WZ-K23-E1-03	mosiądz / brass / латунь	
WZ-K23-E1-05	aluminium / aluminium / алюминий	
WZ-K23-E1-06	stal szczotkowana / brushed steel / шлифованная сталь	

*Dostępny na zamówienie / Available only for individual order / Доступен под заказ

Wieszak GRANADA
Hook GRANADA
Крючок GRANADA

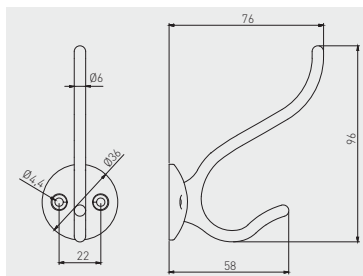

WZ-GRANA-A0-01	chrom / chrome / хром	ZnAl
WZ-GRANA-A0-02	satyna / satin / сатин	

Wieszak K24-A0
Hook K24-A0
Крючок K24-A0

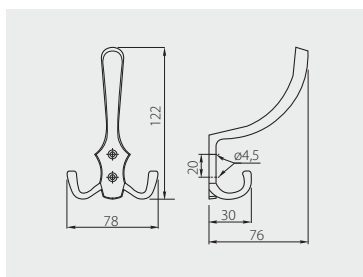

WZ-A0-K24-01	chrom / chrome / хром	ZnAl
WZ-A0-K24-02	satyna / satin / сатин	
WZ-A0-K24-03	mosiądz / brass / латунь	
WZ-A0-K24-04	antyczny mosiądz / antique brass / античная латунь	
WZ-A0-K24-05	aluminium / aluminium / алюминий	
WZ-A0-K24-07	antyczne srebro / antique silver / античное серебро	
WZ-A0-K24-20	czarny mat / black matt / чёрный матовый	

Wieszak K24-B0
Hook K24-B0
Крючок K24-B0

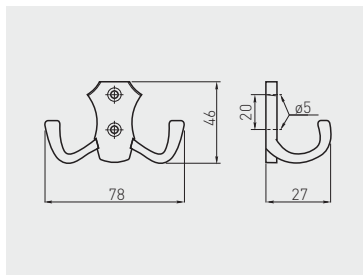

WZ-B0-K24-01	chrom / chrome / хром	ZnAl
WZ-B0-K24-02	satyna / satin / сатин	
WZ-B0-K24-03	mosiądz / brass / латунь	
WZ-B0-K24-04	antyczny mosiądz / antique brass / античная латунь	
WZ-B0-K24-05	aluminium / aluminium / алюминий	
WZ-B0-K24-07	antyczne srebro / antique silver / античное серебро	
WZ-B0-K24-20	czarny mat / black matt / чёрный матовый	



Wieszak K24-C0
Hook K24-C0
Крючок K24-C0

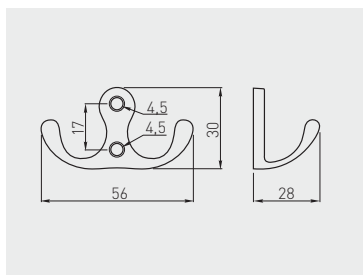

WZ-C0-K24-01	chrom / chrome / хром	ZnAl
WZ-C0-K24-02	satyna / satin / сатин	
WZ-C0-K24-03	mosiądz / brass / латунь	
WZ-C0-K24-04	antyczny mosiądz / antique brass / античная латунь	
WZ-C0-K24-05	aluminium / aluminium / алюминий	
WZ-C0-K24-20	czarny mat / black matt / чёрный матовый	

Wieszak MALAGA A0
Hook MALAGA A0
Крючок MALAGA A0

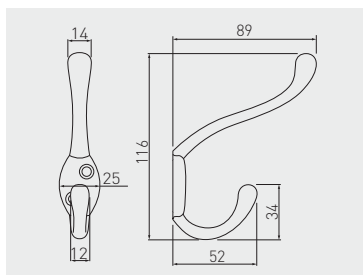

WA-MALAG-A0-01	chrom / chrome / хром	aluminium / aluminium / алюминий
WA-MALAG-A0-02	satyna / satin / сатин	
WA-MALAG-A0-05	aluminium / aluminium / алюминий	
WA-MALAG-A0-20	czarny / black / чёрный	

Wieszak MALAGA B0
Hook MALAGA B0
Крючок MALAGA B0

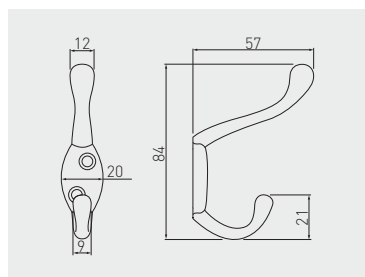

WA-MALAG-B0-01	chrom / chrome / хром	aluminium aluminium алюминий
WA-MALAG-B0-02	satyna / satin / сатин	
WA-MALAG-B0-05	aluminium / aluminium / алюминий	
WA-MALAG-B0-20	czarny / black / чёрный	

Wieszak MALAGA C0
Hook MALAGA C0
Крючок MALAGA C0

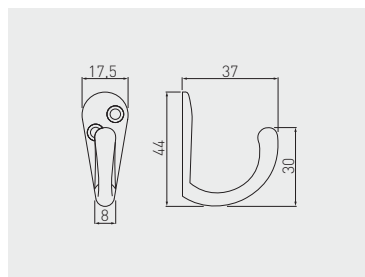

WZ-MALAG-C0-01	chrom / chrome / хром	ZnAl
WZ-MALAG-C0-02	satyna / satin / сатин	
WZ-MALAG-C0-05	aluminium / aluminium / алюминий	
WZ-MALAG-C0-20	czarny / black / чёрный	

Wieszak E18
Hook E18
Крючок E18

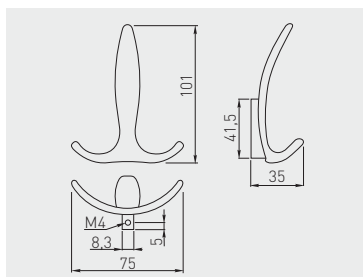

WZ-E-018-01	chrom / chrome / хром	ZnAl
WZ-E-018-02	satyna / satin / сатин	
WZ-E-018-05	aluminium / aluminium / алюминий	
WZ-E-018-06	stal szczotkowana / brushed steel / шлифованная сталь	
WZ-E-018-20M	czarny mat / black matt / чёрный матовый	

Wieszak D892
Hook D892
Крючок D892

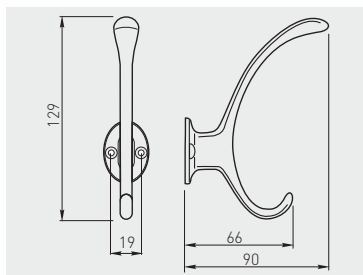

WZ-D-892-02	satyna / satin / сатин	ZnAl
WZ-D-892-05	aluminium / aluminium / алюминий	

Wieszak CORUNA-D
Hook CORUNA-D
Крючок CORUNA-D

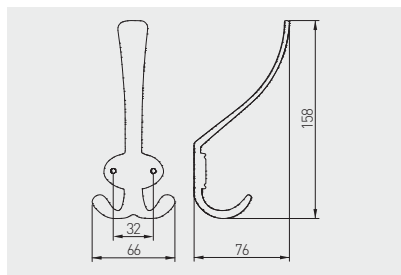

WZ-CORUNA-D-04	antyczny mosiądz / antique brass / античная латунь	ZnAl
WZ-CORUNA-D-07	antyczne srebro / antique silver / античное серебро	
WZ-CORUNA-D-17	brąz / bronze / коричневый	
WZ-CORUNA-D-20M	czarny mat / black matt / чёрный матовый	

Wieszak CORUNA-M
Hook CORUNA-M
Крючок CORUNA-M

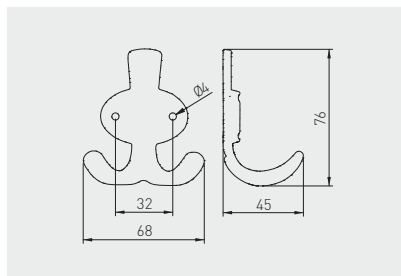

WZ-CORUNA-M-04	antyczny mosiądz / antique brass / античная латунь	ZnAl
WZ-CORUNA-M-07	antyczne srebro / antique silver / античное серебро	
WZ-CORUNA-M-17	brąz / bronze / коричневый	
WZ-CORUNA-M-20M	czarny mat / black matt / чёрный матовый	

Wieszak MADRYT
Hook MADRYT
Крючок MADRYT

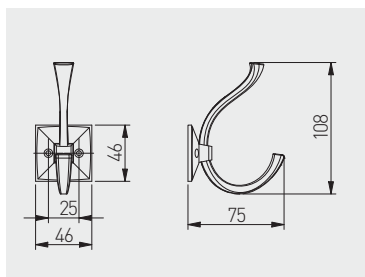

WZ-MADRYT-04	antyczny miedź / antique brass / античная латунь	ZnAl
WZ-MADRYT-07	antyczne srebro / antique silver / античное серебро	
WZ-MADRYT-15	antyczna miedź / antique copper / античная медь	
WZ-MADRYT-20M	czarny mat / black matt / чёрный матовый	



Wieszak ORVIETO A0
 Hook ORVIETO A0
 Крючок ORVIETO A0

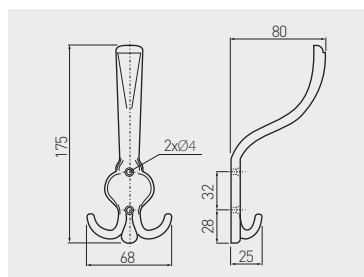

WZ-ORVIE-A0-09

antyczny mosiądz szczotkowany
 antique brushed brass
 античная шлифованная латунь

ZnAl

Wieszak ORVIETO B0
 Hook ORVIETO B0
 Крючок ORVIETO B0

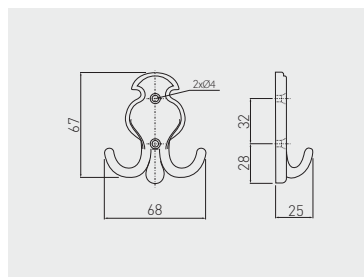

WZ-ORVIE-B0-09

antyczny mosiądz szczotkowany
 antique brushed brass
 античная шлифованная латунь

ZnAl

Wieszak K24
 Hook K24
 Крючок K24

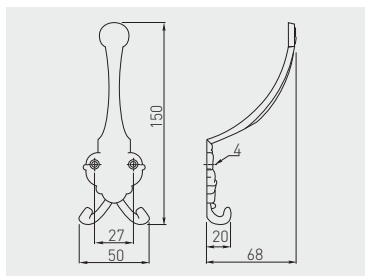

WZ-00-K24-04

antyczny mosiądz / antique brass / античная латунь

ZnAl



Podpórka pod półkę BELT
Shelf support BELT
Полкодержатель BELT

NEW

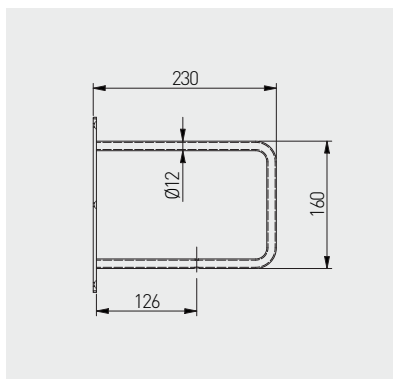

PP-BELT-20M



czarny / black / чёрный



stal / steel / сталь



30

Podpórka pod półkę FLAT
Shelf support FLAT
Полкодержатель FLAT

NEW

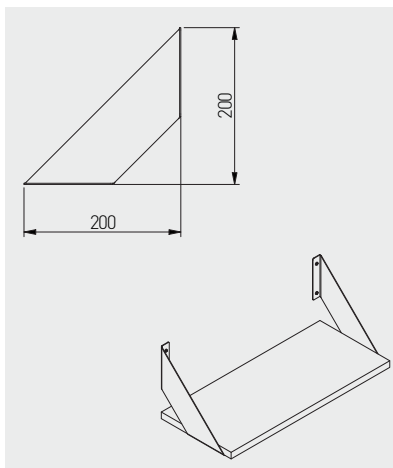

PP-FLAT-20M



czarny / black / чёрный



stal / steel / сталь



15

Podpórka pod półkę GALA
Shelf support GALA
Полкодержатель GALA

NEW

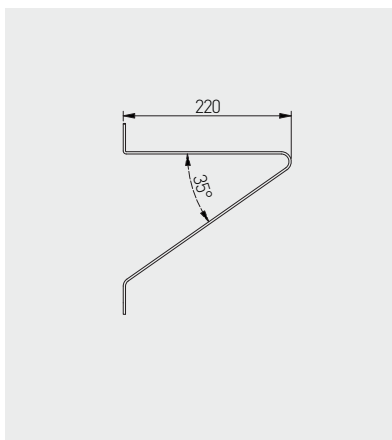

			
PP-GALA-20M	czarny / black / чёрный	stal / steel / сталь	30

Podpórka pod półkę GINO
Shelf support GINO
Полкодержатель GINO

NEW

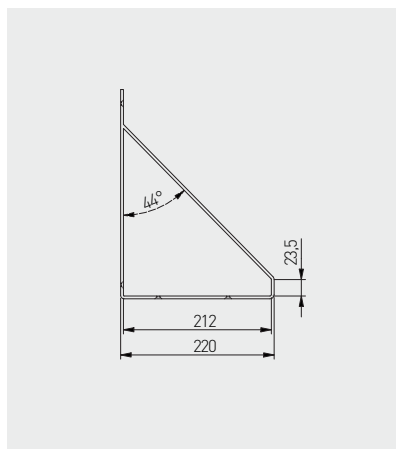

			
PP-GINO-20M	czarny / black / чёрный	stal / steel / сталь	30



Podpórka pod półkę INGRID
Shelf support INGRID
Полкодержатель INGRID

NEW

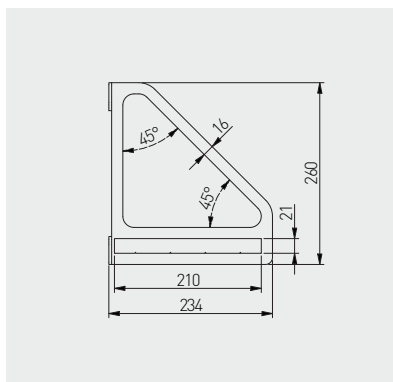

PP-INGRID-20M



czarny / black / чёрный



stal / steel / сталь



20

Podpórka pod półkę NEO
Shelf support NEO
Полкодержатель NEO

NEW

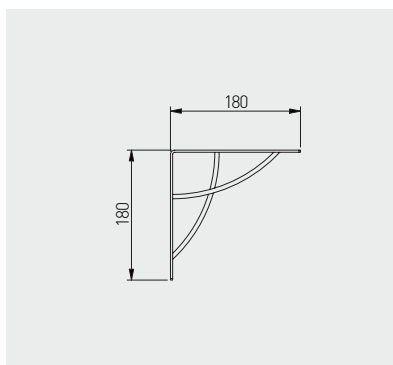

PP-NEO-20M



czarny / black / чёрный



stal / steel / сталь



20



Podpórka pod półkę BAR
Shelf support BAR
Полкодержатель BAR

NEW

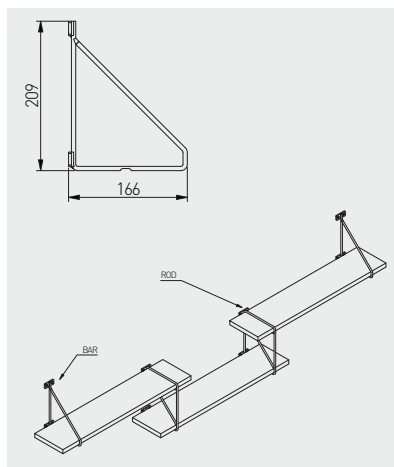

PP-BAR-20M

czarny / black / чёрный



stal / steel / сталь



20

Podpórka pod półkę ROD
Shelf support ROD
Полкодержатель ROD

NEW

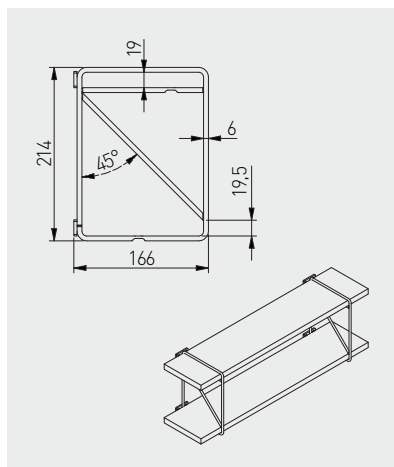

PP-ROD-20M

czarny / black / чёрный



stal / steel / сталь



20

Podpórka pod półkę TREE
Shelf support TREE
Полкодержатель TREE

NEW

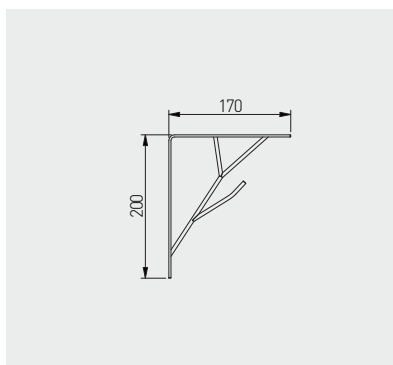

			
PP-TREE-20M	czarny / black / чёрный	stal / steel / сталь	20

Podpórka pod półkę WIRE
Shelf support WIRE
Полкодержатель WIRE



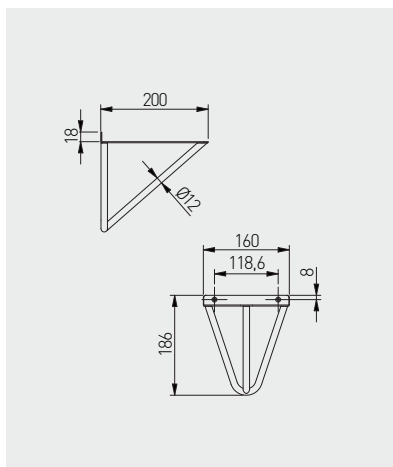

NEW

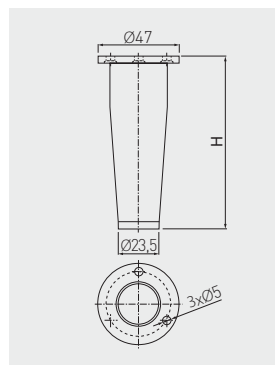

			
PP-WIRE-20M	czarny / black / чёрный	stal / steel / сталь	30





Nóżka B-103
Leg B-103
Ножка B-103

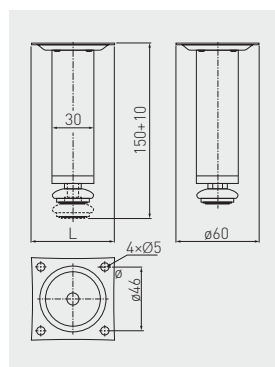

		 H mm			
NM-B103-80-01		80	chrom / chrome / хром	ZnAl	20
NM-B103-80-06			stal szorstkowana / brushed steel / шлифованная сталь		
NM-B103-100-01		100	chrom / chrome / хром		
NM-B103-100-06			stal szorstkowana / brushed steel / шлифованная сталь		
NM-B103-120-01		120	chrom / chrome / хром		
NM-B103-120-06			stal szorstkowana / brushed steel / шлифованная сталь		





Nóżka BD-150 z regulacją
Adjustable leg BD-150
Ножка BD-150 с регулировкой

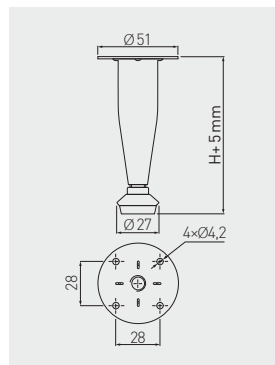

		 H mm			
NM-BD-150-01		150 + 10	chrom / chrome / хром	stal / steel / сталь	80
NM-BD-150-02			satyna / satin / сатин		

Nózka BD-03 z regulacją
Adjustable leg BD-03
Ножка BD-03 с регулировкой



		 H mm			
NM-BD-003-01	100 + 5	100 + 5	chrom / chrome / хром	stal / steel / сталь	100
NM-BD-003-02			satyna / satin / сатин		
NM-BD-003-150-01	150 + 5	150 + 5	chrom / chrome / хром		
NM-BD-003-150-02			satyna / satin / сатин		



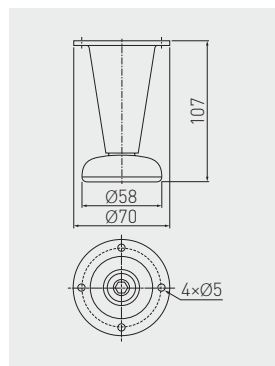

Nózka BD-780
Leg BD-780
Ножка BD-780

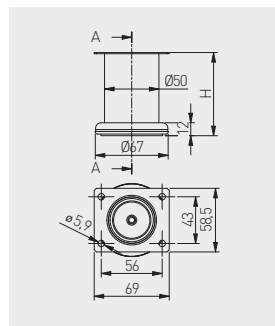

		 H mm			
NM-BD-780-M1	107	107	chrom / chrome / хром	stal / steel / сталь	50
NM-BD-780-M2			satyna / satin / сатин		
NM-BD-780-M5			aluminium / aluminium / алюминий		

Nóżka B1-140
Leg B1-140
Ножка B1-140





	 H mm			
NM-B1-140-060-A	60	chrom chrome хром	stal, tworzywo steel, plastic сталь, пластмасса	100
NM-B1-140-080-A	80			100
NM-B1-140-100-A	100			50
NM-B1-140-120-A*	120			100
NM-B1-140-150-A	150			100
NM-B1-140-180-A*	180			50
NM-B1-140-200-A	200			100

* Dostępny na zamówienie / Available only for individual order / Доступен под заказ

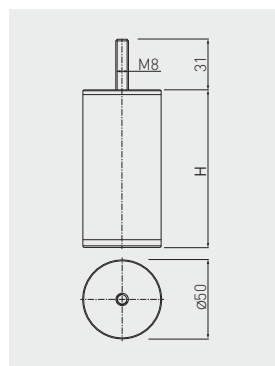
Nóżka STR-50
Leg STR-50
Ножка STR-50



	 H mm			
NM-STR50-100-01	100	chrom chrome хром	stal, tworzywo steel, plastic сталь, пластмасса	80
NM-STR50-120-01	120			
NM-STR50-150-01	150			

Nóżka STR-60*
Leg STR-60*
Ножка STR-60*

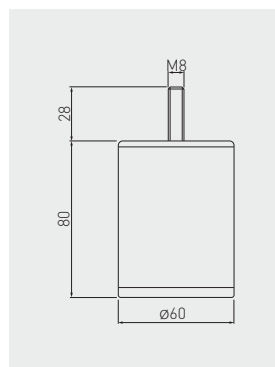



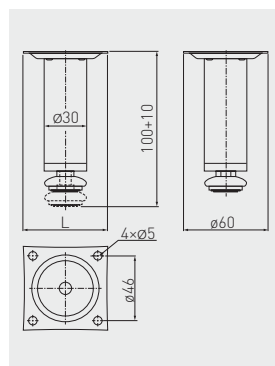

	 mm			
NM-STR60-80-01	80	chrom chrome хром	stal, tworzywo steel, plastic сталь, пластмасса	100

* Dostępny na zamówienie / Available only for individual order / Доступен под заказ





Nóżka BD-100 z regulacją
Adjustable leg BD-100
Ножка BD-100 с регулировкой

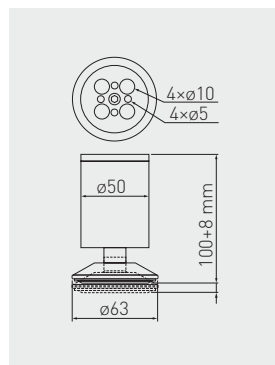

	 mm			
NM-BD-100-01	100 + 10	chrom / chrome / хром	stal steel сталь	100
NM-BD-100-02		satyna / satin / сатин		
NM-BD-100-05		aluminium / aluminium / алюминий		
NM-BD-100-06		stal szcztokowana / brushed steel / шлифованная сталь		

Nózka BD-762 z regulacją
Adjustable leg BD-762
Ножка BD-762 с регулировкой



	 mm			
NM-BD-762-01	100 + 8	chrom / chrome / хром	ZnAl, stal ZnAl, steel ZnAl, сталь	50
NM-BD-762-05		aluminium / aluminium / алюминий		

Nózka BD-867
Leg BD-867
Ножка BD-867

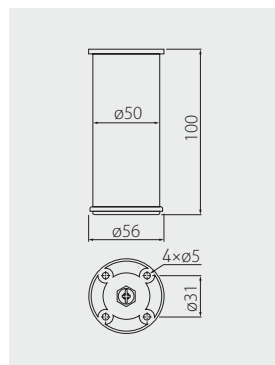

	 mm			
NM-BD867-100	100	aluminium / aluminium / алюминий	aluminium / aluminium / алюминий	50

Nózka BD-868
 Leg BD-868
 Ножка BD-868

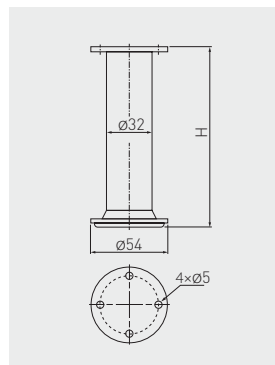

NM-BD868-100	100	aluminium / aluminium / алюминий	aluminium / aluminium / алюминий	50
NM-BD868-150	150			



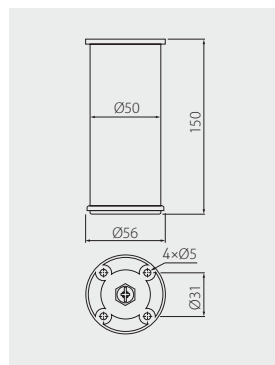

Nózka BD-869
 Leg BD-869
 Ножка BD-869

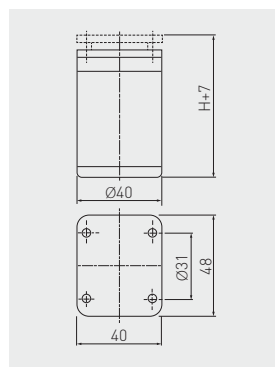

NM-BD869-150	150	aluminium / aluminium / алюминий	aluminium / aluminium / алюминий	50
--------------	-----	----------------------------------	----------------------------------	----





Nóżka DAP-77 z regulacją
Adjustable leg DAP-77
Ножка DAP-77 с регулировкой высоты

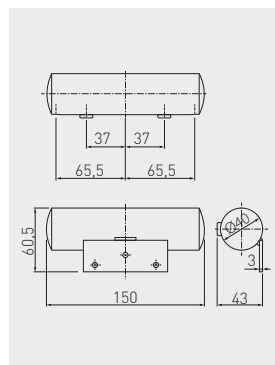

		 H mm			
NM-DAP77-60		60 + 7		aluminium, tworzywo aluminium, plastic алюминий, пластмасса	100
NM-DAP77-100		100 + 7			
NM-DAP77-150		150 + 7			

Nóżka BAHIA*
Leg BAHIA*
Ножка BAHIA*





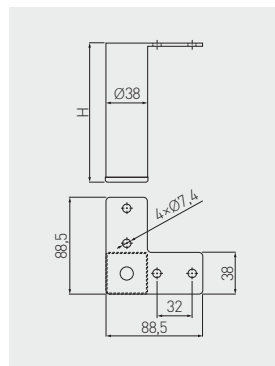

		 H mm			
NM-BAHIA40-150-01		43	chrom / chrome / хром	stal, tworzywo steel, plastic сталь, пластмасса	50

* Dostępny na zamówienie / Available only for individual order / Доступен под заказ





Nóżka B-104
Leg B-104
Ножка B-104

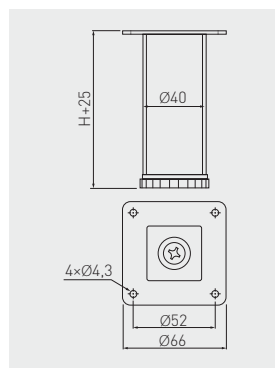

	 H mm			
NM-B104-100-01	100	chrom / chrome / хром	stal / steel / сталь	100
NM-B104-150-01	150			50
NM-B104-200-01	200			50

Nóżka SQ-40 z regulacją
Adjustable leg SQ-40
Ножка SQ-40 с регулировкой высоты





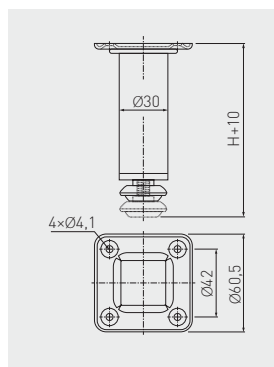

	 H mm			
NM-SQ40ADJ-060	60 + 25	chrom / chrome / хром	stal / steel / сталь	100
NM-SQ40ADJ-060-05*	60 + 25	aluminium aluminium алюминий		
NM-SQ40ADJ-080*	80 + 25			
NM-SQ40ADJ-080-05*	80 + 25			
NM-SQ40ADJ-100	100 + 25	chrom / chrome / хром		50

* Dostępny na zamówienie / Available only for individual order / Доступен под заказ

Nóżka SQA z regulacją
Adjustable leg SQA
Ножка SQA с регулировкой высоты



	 mm			
NM-SQA100-01	100 + 10	chrom / chrome / хром	stal / steel / сталь	100
NM-SQA150-01*	150 + 10			

* Dostępny na zamówienie / Available only for individual order / Доступен под заказ

Nóżka BD-727
Leg BD-727
Ножка BD-727

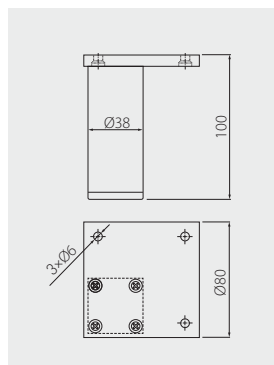

	 mm			
NM-BD727-100	100	aluminium / aluminium / алюминий	aluminium / aluminium / алюминий	50

Nóżka BD-739
Leg BD-739
Ножка BD-739

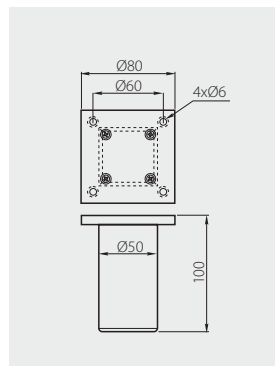

				
NM-BD-739-05	100 mm	aluminium / aluminium / алюминий	aluminium / aluminium / алюминий	50

Nóżka DAK-27 z regulacją
Adjustable leg DAK-27
Ножка DAK-27 с регулировкой высоты

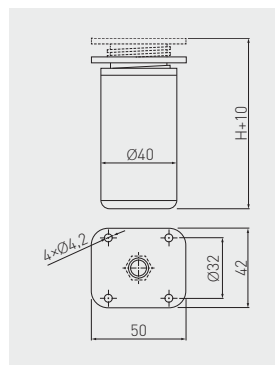

				
NM-DAK27-060	60 + 10	aluminium aluminium алюминий	aluminium, tworzywo aluminium, plastic алюминий, пластмасса	100
NM-DAK27-080	80 + 10			
NM-DAK27-100	100 + 10			
NM-DAK27-120	120 + 10			
NM-DAK27-150	150 + 10			

Nóżka NACK z regulacją*
Adjustable leg NACK*
Ножка NACK с регулировкой высоты*

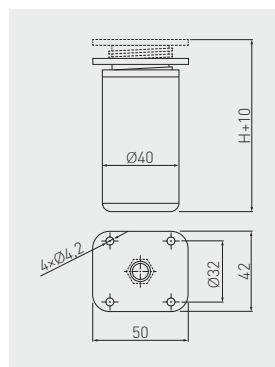



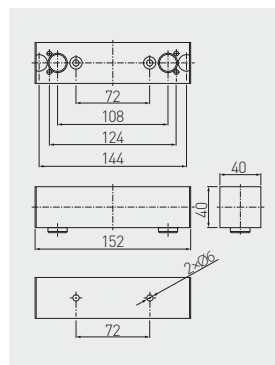

	 H mm			
NM-NACK27651-06	60 + 10	chrom chrome хром	tworzywo, aluminium plastic, aluminium пластмасса, алюминий	100

* Dostępny na zamówienie / Available only for individual order / Доступен под заказ

Nóżka TOKYO*
Leg TOKYO*
Ножка TOKYO*



	 H mm			
NM-TOKYO40-150-01	40	chrom / chrome / хром	stal, tworzywo steel, plastic сталь, пластмасса	50

* Dostępny na zamówienie / Available only for individual order / Доступен под заказ

Nózka BD-01
Leg BD-01
Ножка BD-01

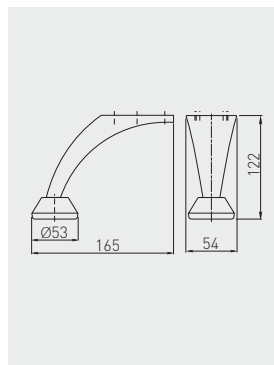

	 mm			
NM-BD-001-M1B	122	chrom / chrome / хром	stal / steel / сталь	80

Nózka BD-712
Leg BD-712
Ножка BD-712

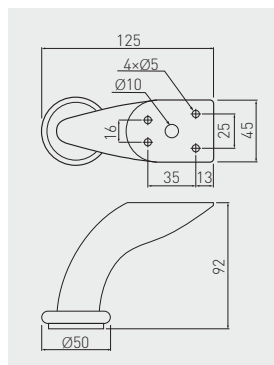

	 mm			
NM-BD-712-M1	92	chrom / chrome / хром	stal / steel / сталь	50

*Dostępny na zamówienie / Available only for individual order / Доступен под заказ



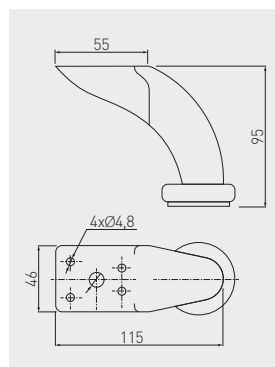

Nóżka STGC 50
Leg STGC 50
Ножка STGC 50

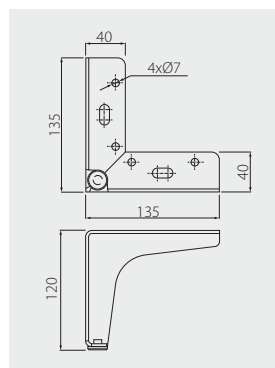

	 mm			
NM-STGC50-95-01	95	chrom / chrome / хром	stal / steel / сталь	100

Nóżka STGY 135
Leg STGY 135
Ножка STGY 135



	 mm			
NM-STGY135-100-01	100	chrom / chrome / хром	stal, tworzywo steel, plastic сталь, пластик	50
NM-STGY135-130-01	130			
NM-STGY135-150-01	150			

Nóżka STGY-135
Leg STGY-135
Ножка STGY-135

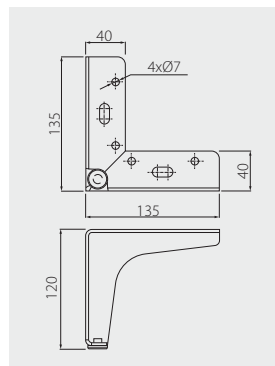

NM-STGY135-120-01	120 mm	chrom / chrome / хром	stal / steel / сталь	50

Nóżka STOMP
Leg STOMP
Ножка STOMP

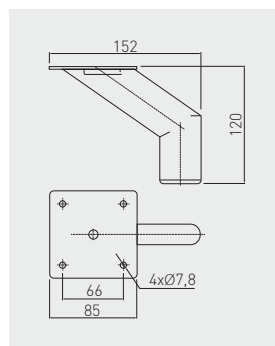

NM-STOMP-100-01*	100	chrom / chrome / хром		100
NM-STOMP-120-10*	120	biały / white / белый		stal steel сталь
NM-STOMP-120-20		czarny / black / чёрный		
NM-STOMP-130-01*	130	chrom / chrome / хром		
NM-STOMP-130-06*		stal szcztokowana / brushed steel / шлифованная сталь		
NM-STOMP-130-20*		czarny / black / чёрный		
NM-STOMP-150-01*	150	chrom / chrome / хром		
NM-STOMP-160-01*	160	stal szcztokowana / brushed steel / шлифованная сталь		
NM-STOMP-160-06*		czarny / black / чёрный		
NM-STOMP-160-20*		czarny / black / чёрный		

*Dostępny na zamówienie / Available only for individual order / Доступен под заказ

Nóżka STOMP
Leg STOMP
Ножка STOMP

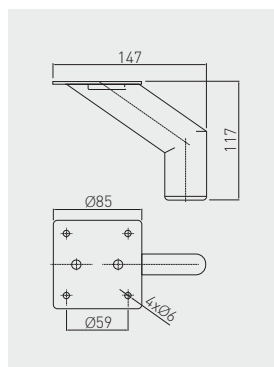

				
NM-STOMP-120-01	117 mm	chrom / chrome / хром	stal / steel / сталь	60

Nóżka STPL 135
Leg STPL 135
Ножка STPL 135

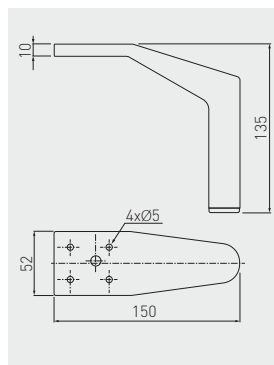

				
NM-STPL-135-01	135 mm	chrom / chrome / хром	stal / steel / сталь	50



Nóżka MDN-D4
Leg MDN-D4
Ножка MDN-D4

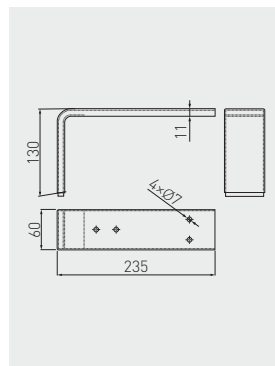

NM-MDN-D4-01	130	chrom / chrome / хром	stal / steel / сталь	25
--------------	-----	-----------------------	----------------------	----

Nóżka XH-30*
Leg XH-30*
Ножка XH-30*

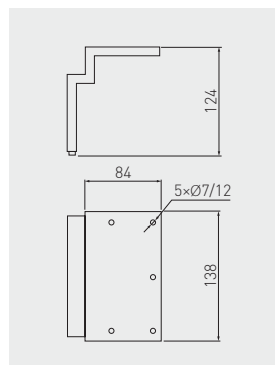

NM-XH3065-05	124	aluminium / aluminium / алюминий	aluminium / aluminium / алюминий	20
--------------	-----	----------------------------------	----------------------------------	----

* Dostępny na zamówienie / Available only for individual order / Доступен под заказ

Nóżka XH-82
Leg XH-82
Ножка XH-82

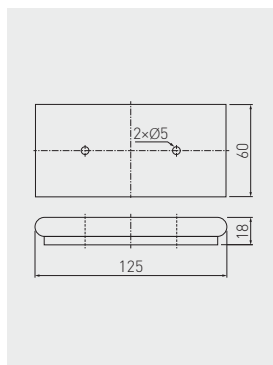

				
NM-XH8273-01	18	chrom / chrome / хром	ZnAl	100

Nóżka MDN-926
Leg MDN-926
Ножка MDN-926

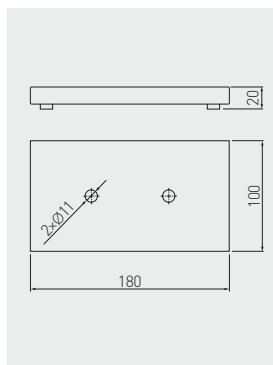

				
NM-MDN926-01	20	chrom / chrome / хром	stal / steel / сталь	50

Nózka MDN-927
Leg MDN-927
Ножка MDN-927

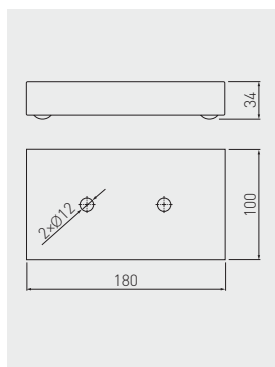

NM-MDN927-01	34	chrom / chrome / хром	stal / steel / сталь	50
--------------	----	-----------------------	----------------------	----

Nózka MDN-941
Leg MDN-941
Ножка MDN-941

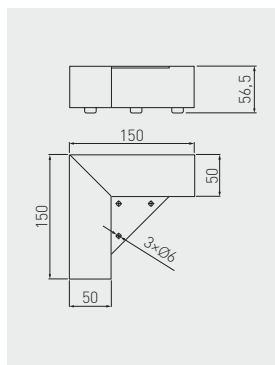

NM-MDN941-01	56	chrom / chrome / хром	stal / steel / сталь	25
--------------	----	-----------------------	----------------------	----

Nóżka STSL
Leg STSL
Ножка STSL

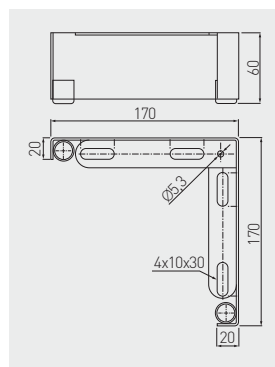

NM-STSL-170-60-01



60
mm



chrom / chrome / хром



stal / steel / сталь



40



Ślizgacz WPJ z regulacją
Adjustable furniture slider WPJ
Опора WPJ с регулировкой

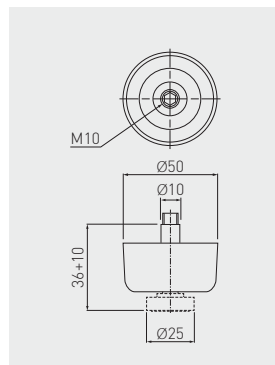

NM-WPJ22-D20	36 + 10	czarny / black / чёрный	tworzywo / plastic / пластмасса	5
--------------	---------	-------------------------	---------------------------------	---

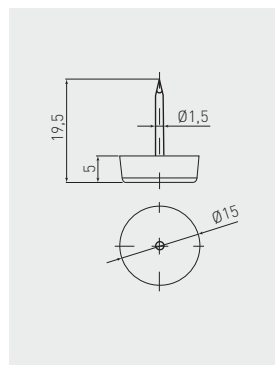

Ślizgacz SLZ pojedynczy
Furniture slider SLZ single
Опора SLZ одинарная



BP-SLZIGW-10	czarny / black / чёрный	tworzywo / plastic / пластмасса
--------------	-------------------------	---------------------------------

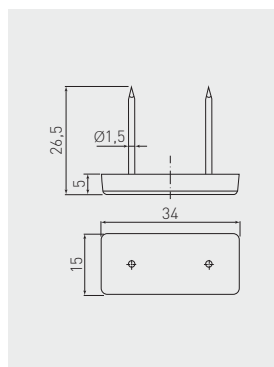

Ślizgacz SLZ podwójny
Furniture slider SLZ double
Опора SLZ двойная



			
BP-SLZIGW-21	czarny black чёрный	tworzywo plastic пластмасса	250

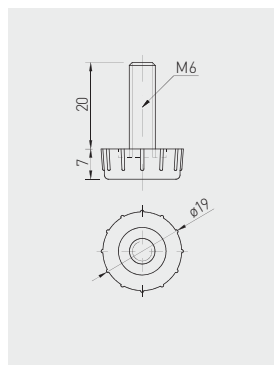



Stopka M6 regulowana
Foot M6 adjustable
Ножка M6 с регулировкой

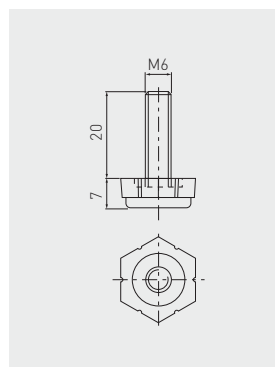

		
NM-STOPKA-M6	ocynk galvanized гальваника	stal, tworzywo steel, plastic сталь, пластмасса

Stopka M6 regulowana sześciokątna
 Foot M6 adjustable hexagonal
 Ножка М6 с регулировкой (шестигранная)



			
NM-STOPK SZESTK-M6	ocynk galvanized гальваника	stal, tworzywo steel, plastic сталь, пластмасса	250

Mufa M6
 Socket M6
 Муфта М6







NM-MUFAWB-00

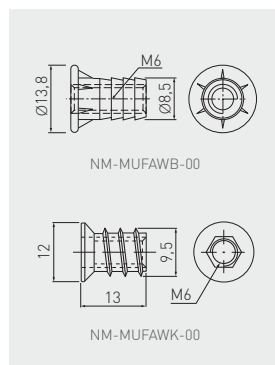

NM-MUFAWK-00



				
NM-MUFAWB-00	wbijana screw-in sleeve врезная	srebrny silver	ZnAl	2500
NM-MUFAWK-00	wkręcana screwed для вкручивания	srebrniany серебряный		4000

Nóżka DPD z regulacją
Adjustable leg DPD
Ножка DPD с регулировкой

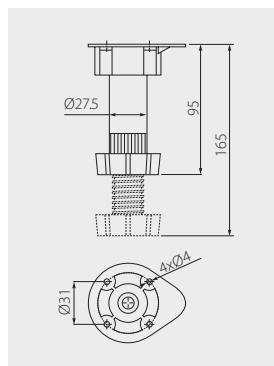

NM-DPD20-100



95 - 165



60



czarny / black / чёрный



tworzywo / plastic / пластмасса



200

Klip do nóżki DPD
Plinth clip DPD
Клипса к ножке DPD

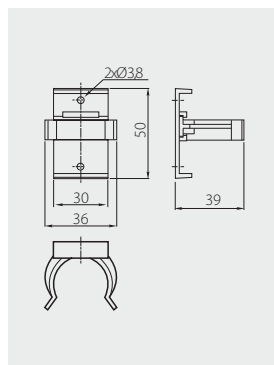

NM-KL-DPL-20



czarny / black / чёрный



tworzywo / plastic / пластмасса



1500

Nóżka DPA
Leg DPA
Ножка DPA

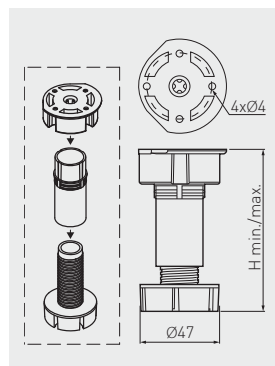

		H mm	kg			
NM-DPA20-100	pakowane w karton packing in box картонная упаковка	87 - 120	100	czarny black чёрный	tworzywo plastic пластмасса	250
NM-DPA20-150		137 - 170				200
NM-DPA20-100W	pakowane w worek packing in plastic bag полиэтиленовый пакет	87 - 120				100
NM-DPA20-150W		137 - 170				400

Klip do nóżki DPA
Plinth clip DPA
Клипса к ножке DPA

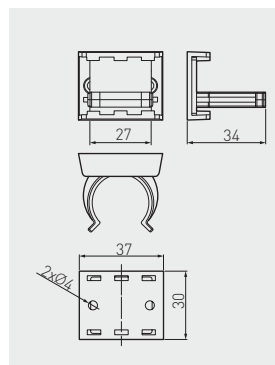

NM-KL-DPA-20	czarny / black / чёрный	tworzywo / plastic / пластмасса
--------------	-------------------------	---------------------------------

Klucz do regulacji nóg DPA / DPD
 Leg adjustment key DPA / DPD
 Ключ регулировки ноги DPA / DPD

NEW

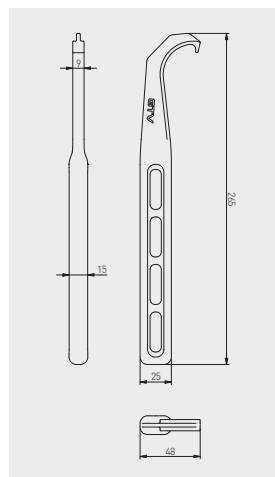

00-KLUCZREG-DPADPD



niebieski / blue / синий



tworzywo / plastic / пластмасса

Nóżka MLA-50 z regulacją
 Adjustable leg MLA-50
 Ножка MLA-50 с регулировкой

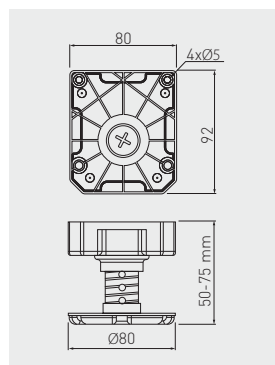

NM-MLA-50-75



50-75



450



czarny / black / чёрный









tworzywo / plastic / пластмасса

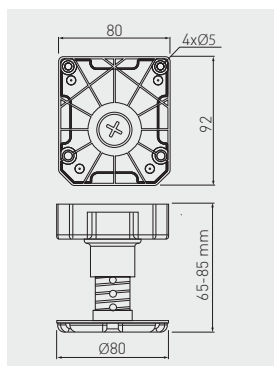

50

Nóżka MLA-65 z regulacją
Adjustable leg MLA-65
Ножка MLA-65 с регулировкой



	 H mm	 kg			
NM-MLA-65-85	65 – 85	450	czarny / black / чёрный	tworzywo / plastic / пластмасса	50

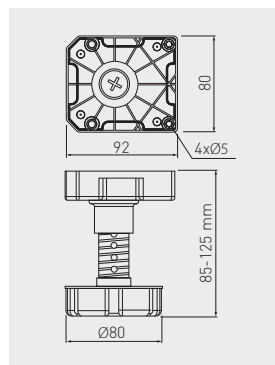

Nóżka MLA-85 z regulacją
Adjustable leg MLA-85
Ножка MLA-85 с регулировкой

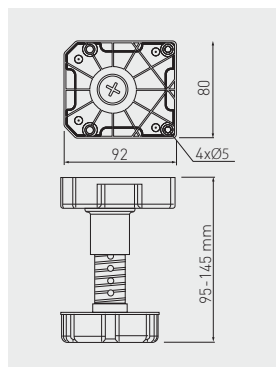

	 H mm	 kg			
NM-MLA-85-125	85 – 125	450	czarny / black / чёрный	tworzywo / plastic / пластмасса	50

Nóżka MLA-95 z regulacją
Adjustable leg MLA-95
Ножка MLA-95 с регулировкой



	 H mm	 kg			
NM-MLA-95-145	95 - 145	450	czarny / black / чёрный	tworzywo / plastic / пластмасса	100

Nóżka MLA-125 z regulacją
Adjustable leg MLA-125
Ножка MLA-125 с регулировкой

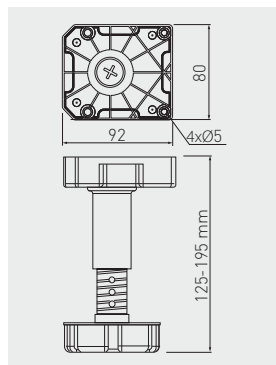

	 H mm	 kg			
NM-MLA-125-195	125 - 195	450	czarny / black / чёрный	tworzywo / plastic / пластмасса	50

Klip do nóżek MLA
 Clip for MLA legs
 Клипса к ножке MLA

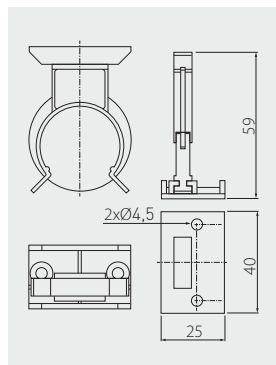

NM-MLA-KL



czarny / black / чёрный



tworzywo / plastic / пластмасса



100

Mechanizm zapadkowy zagłówek sofy
 Ratchet mechanism of the sofa's bolster
 Механизм трансформации подголовника

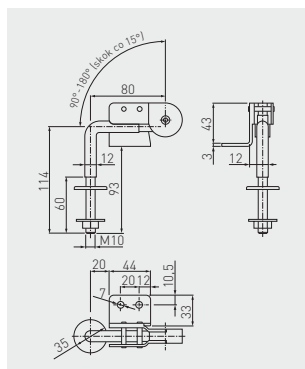

AMS-MPST001-OC



kąt otwarcia 90° – 180°
 opening angle 90° – 180°
 угол открытия 90° – 180°



stal
 steel
 сталь



25

Noga A6 z regulacją
Adjustable leg A6
Опора A6 с регулировкой

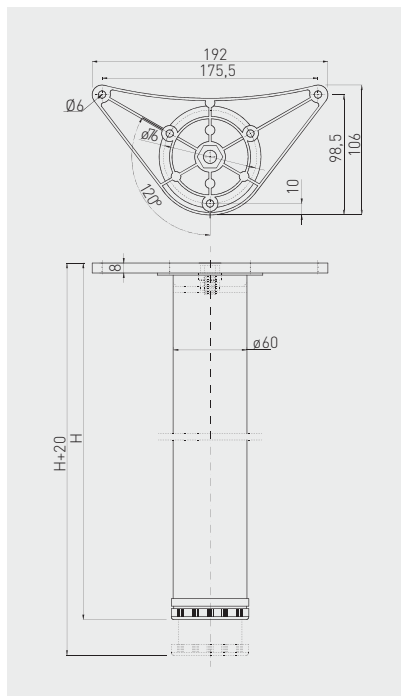

NM-A60710-01	710 + 30	chrom / chrome / хром	ZnAl, stal ZnAl, steel ZnAl, сталь	4
NM-A60710-02		satyna / satin / сатин		
NM-A60710-05		aluminium / aluminium / алюминий		
NM-A60710-10*		biały / white / белый		
NM-A60710-20		czarny / black / чёрный		
NM-A60710-80		srebrny / silver / серебристый		
NM-A60820-01	820 + 30	chrom / chrome / хром		
NM-A60820-02		satyna / satin / сатин		
NM-A60820-05		aluminium / aluminium / алюминий		
NM-A60820-10*		biały / white / белый		
NM-A61100-01	1100 + 30	chrom / chrome / хром		
NM-A61100-02		satyna / satin / сатин		
NM-A61100-05		aluminium / aluminium / алюминий		
NM-A61100-06		stal szczotkowana / brushed steel / шлифованная сталь		
NM-A61100-10*		biały / white / белый		
NM-A61100-20*		czarny / black / чёрный		

* Dostępny na zamówienie / Available only for individual order / Доступен под заказ

Noga NM-A80 z regulacją
Adjustable leg NM-A80
Опора NM-A80 с регулировкой

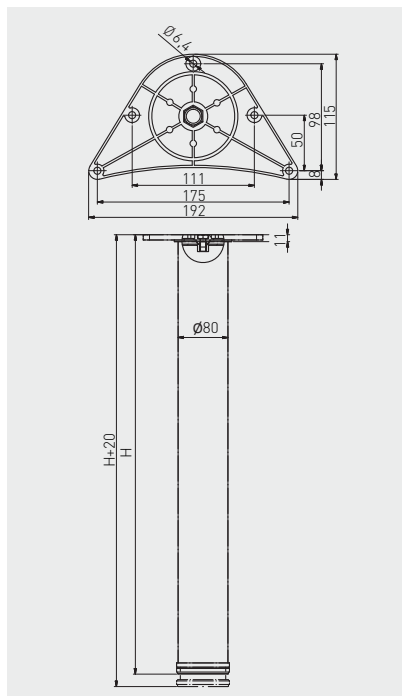



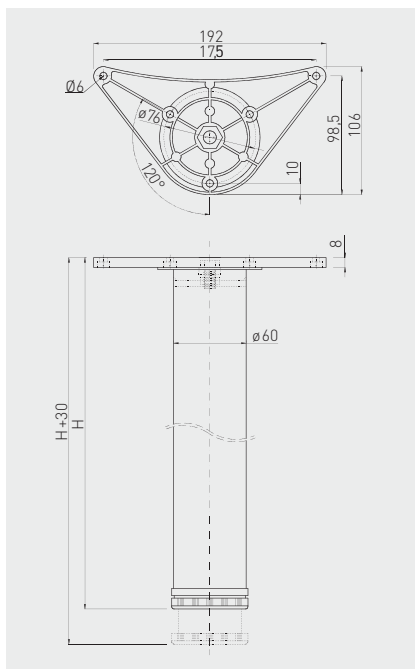

NM-A80710-01*	710 + 20	chrom / chrome / хром	ZnAl, stal ZnAl, steel ZnAl, сталь	2
NM-A80710-02*		satyna / satin / сатин		
NM-A80710-03*		złoty / gold / золото		
NM-A80710-05*		aluminium / aluminium / алюминий		
NM-A80710-06*		stal szczotkowana / brushed steel / шлифованная сталь		
NM-A80710-10*		biały / white / белый		
NM-A80710-20*		czarny / black / чёрный		
NM-A80710-80*	srebrny / silver / серебристый			
NM-A80870-01*	870 + 20	chrom / chrome / хром		
NM-A80870-02*		satyna / satin / сатин		
NM-A80870-03*		złoty / gold / золото		
NM-A80870-05*		aluminium / aluminium / алюминий		
NM-A80870-06*		stal szczotkowana / brushed steel / шлифованная сталь		
NM-A80870-10*		biały / white / белый		
NM-A80870-20*		czarny / black / чёрный		
NM-A80870-80*	srebrny / silver / серебристый			

* Dostępny na zamówienie / Available only for individual order / Доступен под заказ

Noga G6 z regulacją
Adjustable leg G6
Опора G6 с регулировкой



		 H mm			
NM-G60710-01N	710 + 30		chrom / chrome / хром	ZnAl, stal ZnAl, steel ZnAl, сталь	4
NM-G60710-02N			satyna / satin / сатин		
NM-G60710-03N			mosiądz / brass / латунь		
NM-G60710-05N			aluminium / aluminium / алюминий		
NM-G60710-06N			stal szczotkowana / brushed steel / шлифованная сталь		
NM-G60710-10N*			biały / white / белый		
NM-G60710-20N			czarny / black / чёрный		
NM-G60710-80N	srebrny / silver / серебристый				
NM-G60820-01N	820 + 30		chrom / chrome / хром		
NM-G60820-05N			aluminium / aluminium / алюминий		
NM-G60820-06N			stal szczotkowana / brushed steel / шлифованная сталь		
NM-G60820-20N			czarny / black / чёрный		
NM-G61100-01	1100 + 30		chrom / chrome / хром		
NM-G61100-20N			czarny / black / чёрный		

* Na zamówienie dostępna w kolorze białym / For special orders available in white color / Под заказ доступна в белом цвете

Noga S6 z regulacją
Adjustable leg S6
Опора S6 с регулировкой

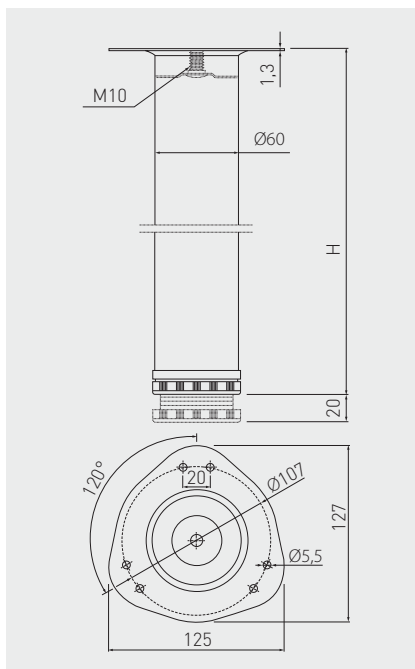

		 H mm			
NM-S60710-01A		710 + 20	chrom / chrome / хром	stal / steel / сталь	4
NM-S60710-02A			satyna / satin / сатин		
NM-S60710-05A			aluminium / aluminium / алюминий		
NM-S60710-10A			biały / white / белый		
NM-S60710-20A			czarny / black / чёрный		
NM-S60820-01A	820 + 20	chrom / chrome / хром			
NM-S60820-02A		satyna / satin / сатин			
NM-S60820-05A		aluminium / aluminium / алюминий			

Noga F-50 składana*
 Leg F-50 foldable*
 Складная опора F-50*

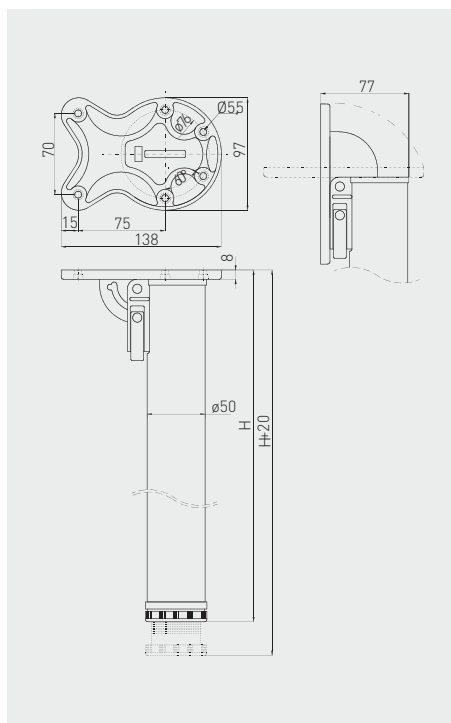





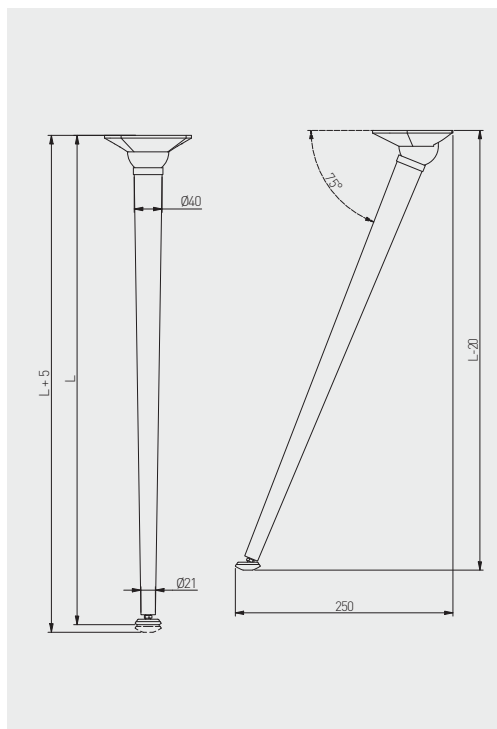

		 H mm			
NM-F50710-01		710 + 20	chrom / chrome / хром	ZnAl, stal, ABS ZnAl, steel, ABS ZnAl, сталь, ABS	8
NM-F50710-06	stal szczotkowana / brushed steel / шлифованная сталь				
NM-F50710-10	biały / white / белый				
NM-F50710-20	czarny / black / чёрный				
NM-F50870-01		870 + 20	chrom / chrome / хром		
NM-F50870-06	stal szczotkowana / brushed steel / шлифованная сталь				
NM-F50870-10	biały / white / белый				
NM-F50870-20	czarny / black / чёрный				

* Dostępny na zamówienie / Available only for individual order / Доступен под заказ

Noga X-LINE skośna
X-LINE oblique leg
X-LINE косяя нога

NEW



	 mm			
NM-X-LINE40710-01	710	chrom / chrome / хром	stal + tworzywo steel + plastic сталь + пластмасса	4
NM-X-LINE40710-20	710	czarny / black / чёрный		
NM-X-LINE40710-10	710	biały / white / белый		
NM-X-LINE40820-20	820	czarny / black / чёрный		
NM-X-LINE40870-20	870			
NM-X-LINE401100-20	1100			



Noga kwadratowa z regulacją
 Square furniture leg
 Мебельная опора с регулировкой

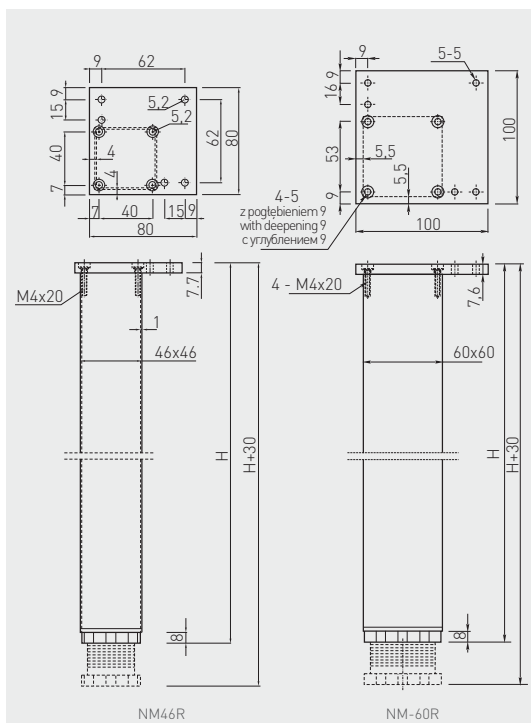
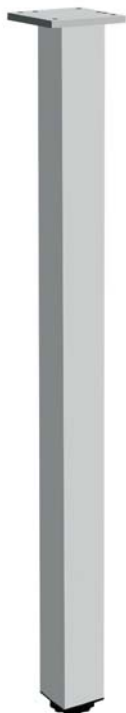



		 H mm			
NM-46R710-05		710 + 30	aluminium / aluminium / алюминий	aluminium aluminium алюминий	4
NM-46R820-05		820 + 30			
NM-60R710-05		710 + 30			
NM-60R820-05		820 + 30			
NM-60R710-05		710 + 30	aluminium / aluminium / алюминий		
NM-60R710-06*			stal szczotkowana / brushed steel / шлифованная сталь		
NM-60R710-20*			czarny / black / чёрный		
NM-60R1100-05*		1100 + 30	aluminium / aluminium / алюминий		
NM-60R1100-20*			czarny / black / чёрный		

* Dostępna na zamówienie / Available only for individual order / Доступен под заказ

* Na indywidualne zamówienie dostępna w wysokości 1100 mm / For special orders 1100 mm height also available / Под заказ доступна также с высотой 1100 мм

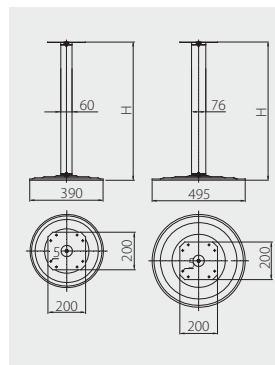
Noga barowa
Bar leg
Барная опора



		 H mm	 Ø mm			
NM-380X730-01		735	60	chrom / chrome / хром	stal / steel / сталь	2
NM-480X730-01		735	76			



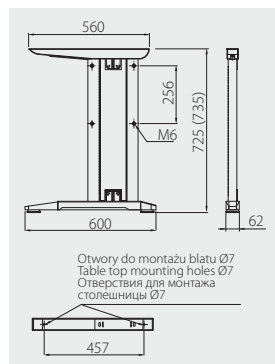



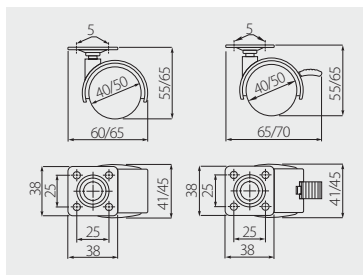

Stelaż biurkowy
Metal frames for desk
Металлический каркас для стола



		 H mm			
SB-A60X72-80		725 (735)	srebrny / silver / серебристый	stal / steel / сталь	1





Rolka KM-D20
Furniture caster KM-D20
Колёсики KM-D20

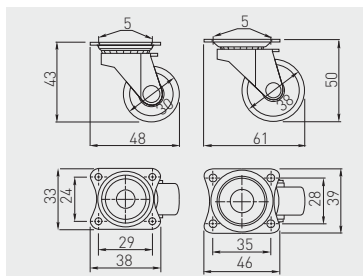

		 mm	 kg		
KM-00-40-D20	bez hamulca without break без стопора	40	18		
KM-00-50-D20		50	22		
KM-0H-40-D20	z hamulcem with break со стопором	40	18		
KM-0H-50-D20		50	22		
				czarny black чёрный	stal + tworzywo steel + plastic сталь + пластмасса





Rolka KM 15 plastikowa
Furniture caster KM 15 plastic
Пластиковые колёсики KM 15

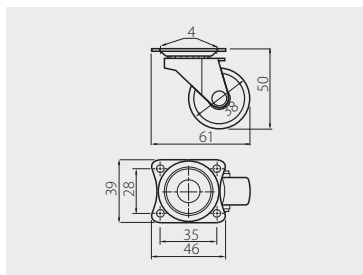

	 mm	 kg		
KM-015030-10	30	13,5	biały / white / белый	stal + tworzywo steel + plastic сталь + пластмасса
KM-015030-20			czarny / black / чёрный	
KM-015038-10	38	16	biały / white / белый	







Rolka KM 15 gumowa
 Rubber furniture caster KM 15
 Резиновые колёсики KM 15

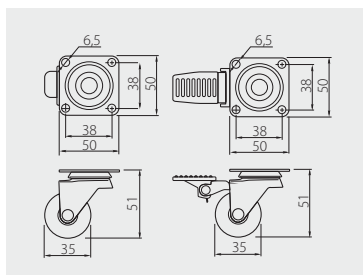

	 mm	 kg		
KM-015038-GM	38	16	czarny / black / чёрный	stal + guma steel + rubber сталь + резина







Rolka KMA 35
 Furniture caster KMA 35
 Колёсики KMA 35

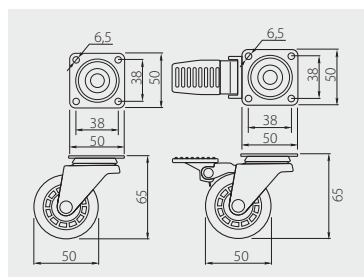

		 mm	 kg		
KM-A035MM-00	bez hamulca without break без стопора	35	25	przeźroczysty / transparent / прозрачный	PC / PU
KM-A035MM-30				brązowy / brown / коричневый	
KM-AH35MM-00	z hamulcem with break со стопором			przeźroczysty / transparent / прозрачный	
KM-AH35MM-30	brązowy / brown / коричневый				







Rolka KMA 50
Furniture caster KMA 50
Колёсики KMA 50

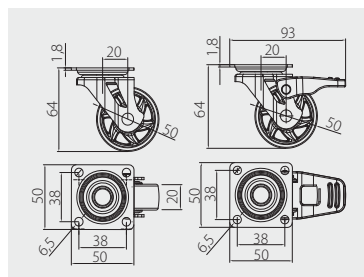

					
KM-A050MM-00	bez hamulca without break без стопора	50	35	przeźroczysty / transparent / прозрачный	PC / PU
KM-A050MM-30	brąz / brown / коричневый				
KM-AH50MM-00	z hamulcem with break со стопором			przeźroczysty / transparent / прозрачный	
KM-AH50MM-30	brąz / brown / коричневый				





Rolka SHIFT 50
Furniture caster SHIFT 50
Колёсики SHIFT 50

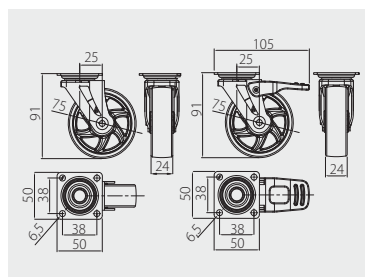

					
KM-B050MM-00	bez hamulca without break без стопора	50	30	przeźroczysty / transparent / прозрачный	PC / PU
KM-B050MM-30	brąz / brown / коричневый				
KM-BH50MM-00	z hamulcem with break со стопором			przeźroczysty / transparent / прозрачный	
KM-BH50MM-30	brąz / brown / коричневый				





Rolka SHIFT 75
 Furniture caster SHIFT 75
 Колёсики SHIFT 75

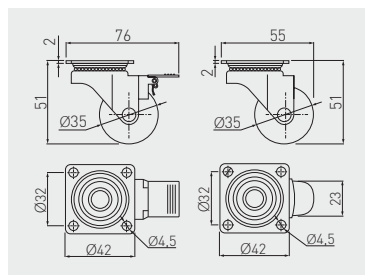

					
KM-B075MM-00	bez hamulca without break без стопора	75	40	przeźroczysty / transparent / прозрачный	PC / PU
KM-B075MM-30				brąz / brown / коричневый	
KM-BH75MM-00	z hamulcem with break со стопором			przeźroczysty / transparent / прозрачный	
KM-BH75MM-30				brąz / brown / коричневый	

Rolka BRAZYLIA 35
 Furniture caster BRAZYLIA 35
 Колёсики BRAZYLIA 35



					
KM-RD-35-SF	bez hamulca without break без стопора	35	30	przeźroczysty / transparent / прозрачный	PC, PU
KM-RD-35-SF-20				czarny / black / чёрный	
KM-RD-35-CF	z hamulcem with break со стопором			przeźroczysty / transparent / прозрачный	
KM-RD-35-CF-20				czarny / black / чёрный	

Rolka BRAZYLIA 50
 Furniture caster BRAZYLIA 50
 Колёсики BRAZYLIA 50

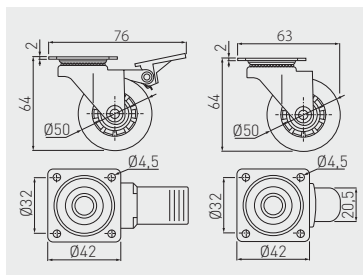

KM-RD-50-SF	bez hamulca without break без стопора	50	40	przeźroczysty / transparent / прозрачный		
KM-RD-50-SF-20				czarny / black / чёрный		
KM-RD-50-CF	z hamulcem with break со стопором			przeźroczysty / transparent / прозрачный		PC, PU
KM-RD-50-CF-20				czarny / black / чёрный		

Rolka BRAZYLIA 75
 Furniture caster BRAZYLIA 75
 Колёсики BRAZYLIA 75

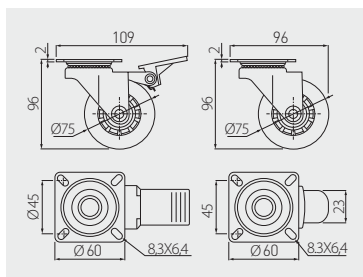



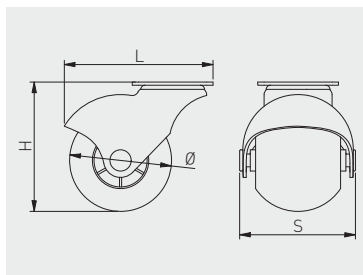

KM-RD-75-SF	bez hamulca without break без стопора	75	64	przeźroczysty / transparent / прозрачный		
KM-RD-75-SF-20				czarny / black / чёрный		
KM-RD-75-CF	z hamulcem with break со стопором			przeźroczysty / transparent / прозрачный		PC, PU
KM-RD-75-CF-20				czarny / black / чёрный		

Rolka SPAIN
Furniture Castor SPAIN
Мебельные ролики SPAIN

NEW







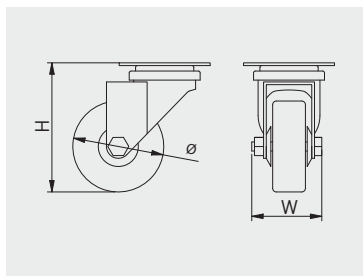

	 mm	 kg		
KM-SPAIN-40MM-18	40	15	szary, grey, серый	stal + guma steel + rubber сталь + резина
KM-SPAIN-50MM-18	50	20		

Rolka GREYROLL
Castor GREYROLL
Ролики GREYROLL

NEW



		 mm	 kg		
KM-GREYROLL-50mm-BH	bez hamulca without break без стопора	50	40	szary, grey, серый	stal + guma steel + rubber сталь + резина
KM-GREYROLL-75mm-BH		75	55		
KM-GREYROLL-50mm-ZH	z hamulcem with break со стопором	50	40		
KM-GREYROLL-75mm-ZH		75	55		

**SYSTEMY PRZESUWNE
SLIDING DOOR SYSTEMS
РАЗДВИЖНЫЕ СИСТЕМЫ**

Dolny układ jezdny
Bottom-running systems
Нижняя ходовая система

418 – 448

Górny układ jezdny
Top-running systems
Верхняя ходовая система





449 – 453



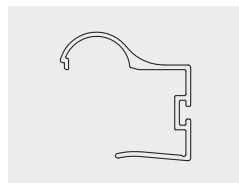

Rączka ERGO
Handle ERGO
Ручка ERGO



	 L mm		
A-R18ERG-270-05	2700	aluminium / aluminium / алюминий	aluminium aluminium алюминий
A-R18ERG-270-90		szampan / champagne / шампань	



Rączka ERGO 16
Handle ERGO 16
Ручка ERGO 16

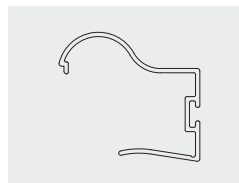

	 L mm		
A-R16ERG-220-05	2200	aluminium / aluminium / алюминий	aluminium aluminium алюминий
A-R16ERG-230-50	2300	aluminium nieanodowane / aluminum, not anodized / грязный серый	
A-R16ERG-270-50	2700	aluminium nieanodowane / aluminum, not anodized / грязный серый	
A-R16ERG-270-90	2700	szampan / champagne / шампань	



Rączka GEO 18
Handle GEO 18
Ручка GEO 18

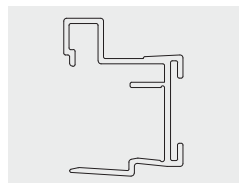

	 L mm		
A-R18GEO2-270-05	2700	aluminium / aluminium / алюминий	aluminium / aluminium / алюминий







+



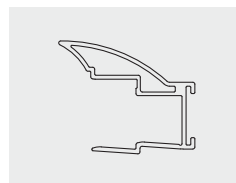

Rączka NOVO 2
Handle NOVO 2
Ручка NOVO 2



	 L mm		
A-RNOV2-270-05	2700	aluminium / aluminium / алюминий	aluminium aluminium алюминий
A-RNOV2-270-10		biały / white / белый	
A-RNOV2-270-90		szampan / champagne / шампань	



Rączka NOVO S
Handle NOVO S
Ручка NOVO S

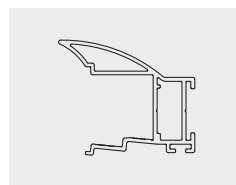







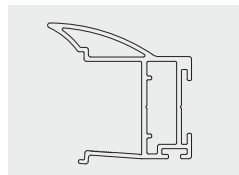

	 L mm		
A-R18NOVS-270-05	2700	aluminium / aluminium / алюминий	aluminium aluminium алюминий
A-R18NOVS-270-10		biały / white / белый	
A-R18NOVS-270-20M		czarny / black / чёрный	
A-R18NOVS-270-90		szampan / champagne / шампань	











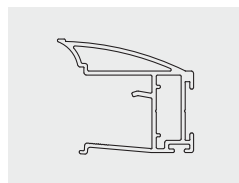

Rączka NOVO S 19
Handle NOVO S 19
Ручка NOVO S 19



	 L 3000		
A-R19NOVS-300-05	3000	aluminium / aluminium / алюминий	aluminium / aluminium / алюминий
 BOARD 19 mm	 FRAME	 FRAMELESS	 × 24







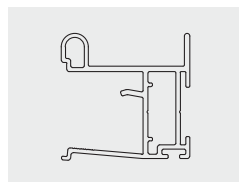

Rączka CARO
Handle CARO
Ручка CARO



	 L mm		
A-R18CARO-270-05	2700	aluminium / aluminium / алюминий	aluminium aluminium алюминий
A-R18CARO-270-90		szampan / champagne / шампань	
 BOARD 18 mm	 GLASS 4 mm	 FRAME	 FRAMELESS
 × 20			

Rączka VISTA
Handle VISTA
Ручка VISTA



	 L mm		
A-R18VIS-270-05	2700	aluminium / aluminium / алюминий	aluminium aluminium алюминий
A-R18VIS-270-90		szampan / champagne / шампань	
 BOARD 18 mm	 GLASS 4 mm	 FRAME	 FRAMELESS
 × 24			

Rączka NERO
Handle NERO
Ручка NERO

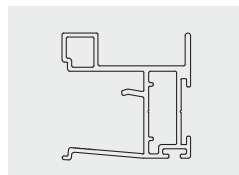

A-R18NERO-270-05	2700	aluminium / aluminium / алюминий	aluminium aluminium алюминий
A-R18NERO-270-10		biały / white / белый	
A-R18NERO-270-20M		czarny / black / чёрный	
A-R18NERO-270-90		szampan / champagne / шампань	



Rączka NERO 19
Handle NERO 19
Ручка NERO 19

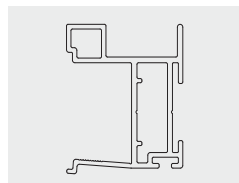

A-R19NERO-300-05	3000	aluminium / aluminium / алюминий	aluminium / aluminium / алюминий



Rączka COTE
Handle COTE
Ручка COTE

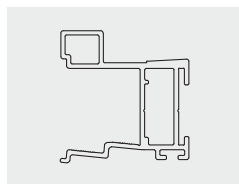





A-R18COTE-270-05	2700	aluminium / aluminium / алюминий	aluminium aluminium алюминий
A-R18COTE-270-90		szampan / champagne / шампань	

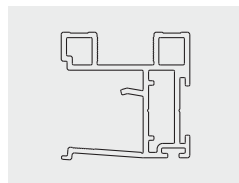

Rączka LOCA
Handle LOCA
Ручка LOCA





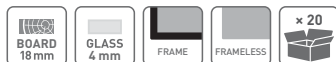

	 L mm		
A-R18LOCA-305-05	3050	aluminium / aluminium / алюминий	aluminium aluminium алюминий
A-R18LOCA-305-90		szampan / champagne / шампань	

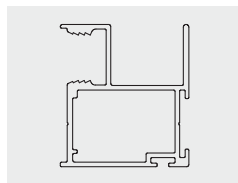

Rączka FLAT LINE
Handle FLAT LINE
Ручка FLAT LINE







	 L mm		
A-R10FL-270-05	2700	aluminium / aluminium / алюминий	aluminium aluminium алюминий
A-R10FL-270-10		biały / white / белый	
A-R10FL-270-90		szampan / champagne / шампань	

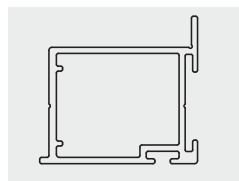

Rączka MOVENA
Handle MOVENA
Ручка MOVENA







	 L mm		
A-R4MOV-270-05	2700	aluminium / aluminium / алюминий	aluminium aluminium алюминий

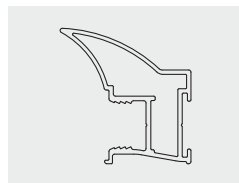

Rączka NOVO 10
Handle NOVO 10
Ручка NOVO 10







	 L mm		
A-R10NOV-270-05	2700	aluminium / aluminium / алюминий	aluminium aluminium алюминий
A-R10NOV-270-10		biały / white / белый	
A-R10NOV-270-90		szampan / champagne / шампань	

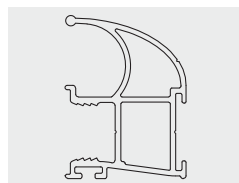

Rączka FORM
Handle FORM
Ручка FORM







	 L mm		
A-R10FORM-270-05	2700	aluminium / aluminium / алюминий	aluminium aluminium алюминий
A-R10FORM-270-90		biały / white / белый	

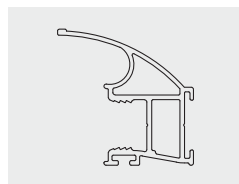

Rączka TRAF0
Handle TRAF0
Ручка TRAF0





	 L mm		
A-R10TRAF0-270-05	2700	aluminium / aluminium / алюминий	aluminium aluminium алюминий
A-R10TRAF0-270-90		szampan / champagne / шампань	

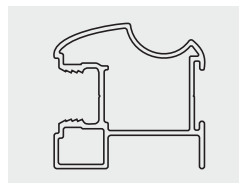

Rączka TORO
Handle TORO
Ручка TORO







			
A-R10TORO-270-05	2700	aluminium / aluminium / алюминий	aluminium aluminium алюминий
A-R10TORO-270-90		szampan / champagne / шампань	

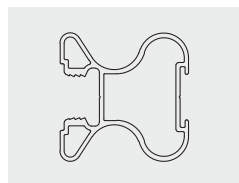

Rączka FALDA
Handle FALDA
Ручка FALDA







			
A-R10FALDA-270-05	2700	aluminium / aluminium / алюминий	aluminium aluminium алюминий
A-R10FALDA-270-90		szampan / champagne / шампань	

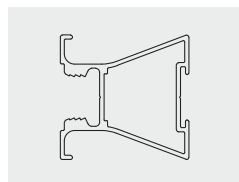

Rączka ARCO
Handle ARCO
Ручка ARCO







			
A-R10ARCO-270-05	2700	aluminium / aluminium / алюминий	aluminium aluminium алюминий
A-R10ARCO-270-90		szampan / champagne / шампань	

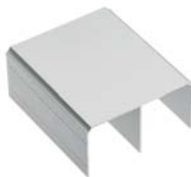

Tor górny
Top track
Верхняя направляющая



	 L mm		
A-TG-170-05	1700	aluminium / aluminium / алюминий	
A-TG-170-10		biały / white / белый	
A-TG-170-20M		czarny / black / чёрный	
A-TG-170-90		szampan / champagne / шампань	
A-TG-235-05	2350	aluminium / aluminium / алюминий	
A-TG-235-10		biały / white / белый	
A-TG-235-20M		czarny / black / чёрный	
A-TG-235-90		szampan / champagne / шампань	
A-TG-300-05	3000	aluminium / aluminium / алюминий	
A-TG-300-10		biały / white / белый	
A-TG-300-20M		czarny / black / чёрный	
A-TG-300-90		szampan / champagne / шампань	
A-TG-405-05	4050	aluminium / aluminium / алюминий	
A-TG-405-10		biały / white / белый	
A-TG-405-20M		czarny / black / чёрный	
A-TG-405-90		szampan / champagne / шампань	
A-TG-600-05	6000	aluminium / aluminium / алюминий	
A-TG-600-10		biały / white / белый	
A-TG-600-20M		czarny / black / чёрный	
A-TG-600-90		szampan / champagne / шампань	



Tor dolny EVO Bottom track EVO Нижняя направляющая EVO



			
A-TDEVO-170-05	1700	aluminium / aluminium / алюминий	aluminium aluminium алюминий
A-TDEVO-170-10		biały / white / белый	
A-TDEVO-170-20M		czarny / black / чёрный	
A-TDEVO-170-90	szampan / champagne / шампань		
A-TDEVO-235-05	2350	aluminium / aluminium / алюминий	
A-TDEVO-235-10		biały / white / белый	
A-TDEVO-235-20M		czarny / black / чёрный	
A-TDEVO-235-90	szampan / champagne / шампань		
A-TDEVO-300-05	3000	aluminium / aluminium / алюминий	
A-TDEVO-300-10		biały / white / белый	
A-TDEVO-300-20M		czarny / black / чёрный	
A-TDEVO-300-90	szampan / champagne / шампань		
A-TDEVO-405-05	4050	aluminium / aluminium / алюминий	
A-TDEVO-405-10		biały / white / белый	
A-TDEVO-405-20M		czarny / black / чёрный	
A-TDEVO-405-90	szampan / champagne / шампань		
A-TDEVO-600-05	6000	aluminium / aluminium / алюминий	
A-TDEVO-600-10		biały / white / белый	
A-TDEVO-600-20M		czarny / black / чёрный	
A-TDEVO-600-90	szampan / champagne / шампань		



Maskownica EVO Masking cover EVO Декоративная накладка





			
A-MEVO-170-05	1700	aluminium / aluminium / алюминий	aluminium aluminium алюминий
A-MEVO-170-10A		biały / white / белый	
A-MEVO-170-20M		czarny / black / чёрный	
A-MEVO-170-90	szampan / champagne / шампань		
A-MEVO-235-05	2350	aluminium / aluminium / алюминий	
A-MEVO-235-10A		biały / white / белый	
A-MEVO-235-20M		czarny / black / чёрный	
A-MEVO-235-90	szampan / champagne / шампань		
A-MEVO-300-05	3000	aluminium / aluminium / алюминий	
A-MEVO-300-10A		biały / white / белый	
A-MEVO-300-20M		czarny / black / чёрный	
A-MEVO-300-90	szampan / champagne / шампань		
A-MEVO-405-05	4050	aluminium / aluminium / алюминий	
A-MEVO-405-10		biały / white / белый	
A-MEVO-405-20M		czarny / black / чёрный	
A-MEVO-405-90	szampan / champagne / шампань		



Tor dolny EVO 2
Bottom track EVO 2
Нижняя направляющая EVO 2



	 L mm		
A-TDEVO2-170-05	1700	aluminium / aluminium / алюминий	aluminium aluminium алюминий
A-TDEVO2-170-90		szampan / champagne / шампань	
A-TDEVO2-235-05	2350	aluminium / aluminium / алюминий	
A-TDEVO2-235-90		szampan / champagne / шампань	
A-TDEVO2-300-05	3000	aluminium / aluminium / алюминий	
A-TDEVO2-300-90		szampan / champagne / шампань	
A-TDEVO2-405-05	4050	aluminium / aluminium / алюминий	
A-TDEVO2-405-90		szampan / champagne / шампань	
A-TDEVO2-600-05	6000	aluminium / aluminium / алюминий	
A-TDEVO2-600-90		szampan / champagne / шампань	



Tor dolny PRO
Bottom track PRO
Нижняя направляющая PRO



	 L mm		
A-TDPRO-170-05	1700	aluminium / aluminium / алюминий	aluminium aluminium алюминий
A-TDPRO-170-10		biały / white / белый	
A-TDPRO-170-20M		czarny / black / чёрный	
A-TDPRO-170-90		szampan / champagne / шампань	
A-TDPRO-235-05	2350	aluminium / aluminium / алюминий	
A-TDPRO-235-10		biały / white / белый	
A-TDPRO-235-20M		czarny / black / чёрный	
A-TDPRO-235-90		szampan / champagne / шампань	
A-TDPRO-300-05	3000	aluminium / aluminium / алюминий	
A-TDPRO-300-10		biały / white / белый	
A-TDPRO-300-20M		czarny / black / чёрный	
A-TDPRO-300-90		szampan / champagne / шампань	
A-TDPRO-405-05	4050	aluminium / aluminium / алюминий	
A-TDPRO-405-10		biały / white / белый	
A-TDPRO-405-20M		czarny / black / чёрный	
A-TDPRO-405-90		szampan / champagne / шампань	
A-TDPRO-600-05	6000	aluminium / aluminium / алюминий	
A-TDPRO-600-10		biały / white / белый	
A-TDPRO-600-20M		czarny / black / чёрный	
A-TDPRO-600-90		szampan / champagne / шампань	



Maskownica PRO Masking cover PRO Декоративная накладка PRO



	 L mm		
A-MPRO-170-05	1700	aluminium / aluminium / алюминий	aluminium aluminium алюминий
A-MPRO-170-10		biały / white / белый	
A-MPRO-170-20M		czarny / black / чёрный	
A-MPRO-170-90	2350	szampan / champagne / шампань	
A-MPRO-235-05		aluminium / aluminium / алюминий	
A-MPRO-235-10		biały / white / белый	
A-MPRO-235-20M	3000	czarny / black / чёрный	
A-MPRO-235-90		szampan / champagne / шампань	
A-MPRO-300-05		aluminium / aluminium / алюминий	
A-MPRO-300-10	4050	biały / white / белый	
A-MPRO-300-20M		czarny / black / чёрный	
A-MPRO-300-90		szampan / champagne / шампань	
A-MPRO-405-05	4050	aluminium / aluminium / алюминий	
A-MPRO-405-10		biały / white / белый	
A-MPRO-405-20M		czarny / black / чёрный	
A-MPRO-405-90		szampan / champagne / шампань	



Listwa górna 18/4 mm Top strip 18/4 mm Профиль горизонтальный верхний 18/4 мм



	 L mm		
A-LG18-170-05	1700	aluminium / aluminium / алюминий	aluminium aluminium алюминий
A-LG18-170-90		szampan / champagne / шампань	
A-LG18-235-05	2350	aluminium / aluminium / алюминий	
A-LG18-235-90		szampan / champagne / шампань	
A-LG18-300-05	3000	aluminium / aluminium / алюминий	
A-LG18-300-10		biały / white / белый	
A-LG18-300-20M		czarny / black / чёрный	
A-LG18-300-90	4050	szampan / champagne / шампань	
A-LG18-405-05		aluminium / aluminium / алюминий	
A-LG18-405-10		biały / white / белый	
A-LG18-405-90	6000	szampan / champagne / шампань	
A-LG18-600-05		aluminium / aluminium / алюминий	
A-LG18-600-90		szampan / champagne / шампань	



Listwa dolna 18/4 mm
Bottom strip 18/4 mm
Профиль горизонтальный нижний 18/4 мм



	 L mm		
A-LD18-170-05	1700	aluminium / aluminium / алюминий	aluminium aluminium алюминий
A-LD18-170-90		szampan / champagne / шампань	
A-LD18-235-05	2350	aluminium / aluminium / алюминий	
A-LD18-235-90		szampan / champagne / шампань	
A-LD18-300-05	3000	aluminium / aluminium / алюминий	
A-LD18-300-10		biały / white / белый	
A-LD18-300-20M		czarny / black / чёрный	
A-LD18-300-90		szampan / champagne / шампань	
A-LD18-405-05	4050	aluminium / aluminium / алюминий	
A-LD18-405-10		biały / white / белый	
A-LD18-405-90		szampan / champagne / шампань	
A-LD18-600-05	6000	aluminium / aluminium / алюминий	
A-LD18-600-90		szampan / champagne / шампань	



Listwa górna 19 mm
Top strip 19 mm
Профиль горизонтальный верхний 19 мм



	 L mm		
A-LG19-300-05	3000	aluminium aluminium алюминий	aluminium aluminium алюминий



Listwa dolna 19 mm
Bottom strip 19 mm
Профиль горизонтальный нижний 19 мм





	 L mm		
A-LD19-300-05	3000	aluminium aluminium алюминий	aluminium aluminium алюминий



Listwa górna 10/4 mm
Top strip 10/4 mm
Профиль горизонтальный верхний 10/4 мм







	 L mm		
A-LG10-170-05	1700	aluminium / aluminium / алюминий	aluminium aluminium алюминий
A-LG10-235-05	2350	aluminium / aluminium / алюминий	
A-LG10-235-90		szampan / champagne / шампань	
A-LG10-300-05	3000	aluminium / aluminium / алюминий	
A-LG10-300-10		biały / white / белый	
A-LG10-300-90		szampan / champagne / шампань	
A-LG10-405-05	4050	aluminium / aluminium / алюминий	
A-LG10-405-90		szampan / champagne / шампань	
A-LG10-600-05	6000	aluminium / aluminium / алюминий	
A-LG10-600-90		szampan / champagne / шампань	



Listwa dolna 10/4 mm
Bottom strip 10/4 mm
Профиль горизонтальный нижний 10/4 мм







	 L mm		
A-LD10-170-05	1700	aluminium / aluminium / алюминий	aluminium aluminium алюминий
A-LD10-235-05	2350	aluminium / aluminium / алюминий	
A-LD10-235-90		szampan / champagne / шампань	
A-LD10-300-05	3000	aluminium / aluminium / алюминий	
A-LD10-300-10		biały / white / белый	
A-LD10-300-90		szampan / champagne / шампань	
A-LD10-405-05	4050	aluminium / aluminium / алюминий	
A-LD10-405-90		szampan / champagne / шампань	
A-LD10-600-05	6000	aluminium / aluminium / алюминий	
A-LD10-600-90		szampan / champagne / шампань	



Listwa górna 4 mm
Top strip 4 mm
Профиль горизонтальный верхний 4 мм







	 L mm		
A-LG4MOV-300-05	3000	aluminium / aluminium / алюминий	aluminium aluminium алюминий



Listwa dolna 4 mm
Bottom strip 4 mm
Профиль горизонтальный нижний 4 мм







	 L mm		
A-LD4MOV-300-05	3000	aluminium / aluminium / алюминий	aluminium aluminium алюминий



Listwa górna FL 10/4 mm
Top strip FL 10/4 mm
Профиль горизонтальный верхний FL 10/4 мм







	 L mm		
A-LG10FL-235-05	2350	aluminium / aluminium / алюминий	aluminium aluminium алюминий
A-LG10FL-235-90		szampan / champagne / шампань	
A-LG10FL-300-05	3000	aluminium / aluminium / алюминий	
A-LG10FL-300-10		biały / white / белый	
A-LG10FL-300-90		szampan / champagne / шампань	



Listwa dolna FL 10,4 mm
 Bottom strip FL 10/4 mm
 Профиль горизонтальный нижний FL 10/4 мм



	 L mm		
A-LD10FL-235-05	2350	aluminium / aluminium / алюминий	aluminium aluminium алюминий
A-LD10FL-235-90		szampan / champagne / шампань	
A-LD10FL-300-05	3000	aluminium / aluminium / алюминий	
A-LD10FL-300-10		biały / white / белый	
A-LD10FL-300-90		szampan / champagne / шампань	



Kątownik
 Angle bar
 Профиль угловой





	 L mm		
A-K18-300-05	3000	aluminium / aluminium / алюминий	aluminium aluminium алюминий
A-K18-300-10		biały / white / белый	
A-K18-300-20M		czarny / black / чёрный	
A-K18-300-90		szampan / champagne / шампань	



Profil C18
Profile C18
Профиль C18







			
A-C18-300-S-05	3000	aluminium / aluminium / алюминий	aluminium aluminium алюминий
A-C18-300-S-10		biały / white / белый	
A-C18-300-S-20M		czarny mat / black matt / чёрный матовый	
A-C18-300-S-90		szampan / champagne / шампань	



Profil T18
Profile T18
Профиль T18





			
A-T18-300-05	3000	aluminium / aluminium / алюминий	aluminium aluminium алюминий
A-T18-300-10		biały / white / белый	
A-T18-300-90		szampan / champagne / шампань	



Profil H16
Profile H16
Профиль H16







			
A-H16-300-05	3000	aluminium / aluminium / алюминий	aluminium aluminium алюминий
A-H16-300-90		szampan / champagne / шампань	





Profil H18 Profile H18 Профиль H18





	 L mm		
A-H18-300-05	3000	aluminium / aluminium / алюминий	aluminium aluminium алюминий
A-H18-300-10		biały / white / белый	
A-H18-300-20M		czarny / black / чёрный	
A-H18-300-90		szampan / champagne / шампань	



Profil HR18 Profile HR18 Профиль HR18







	 L mm		
A-HR18-300-05	3000	aluminium / aluminium / алюминий	aluminium aluminium алюминий
A-HR18-300-10		biały / white / белый	
A-HR18-300-20M		czarny / black / чёрный	
A-HR18-300-90		szampan / champagne / шампань	



Profil HRS18 Profile HRS18 Профиль HRS18



	 L mm		
A-HRS18-170-05	1700	aluminium / aluminium / алюминий	aluminium aluminium алюминий
A-HRS18-170-90		szampan / champagne / шампань	
A-HRS18-235-90	2350	szampan / champagne / шампань	
A-HRS18-300-05	3000	aluminium / aluminium / алюминий	
A-HRS18-300-90		szampan / champagne / шампань	
A-HRS18-170-90	1700	szampan / champagne / шампань	
A-HRS18-235-05	2350	aluminium / aluminium / алюминий	
HRS18-235-90		szampan / champagne / шампань	



Profil HR19
Profile HR19
Профиль HR19







			
A-HR19-300-05	3000	aluminium / aluminium / алюминий	aluminium / aluminium / алюминий



Profil HR10
Profile HR10
Профиль HR10







			
A-HR10-235-05	2350	aluminium / aluminium / алюминий	aluminium aluminium алюминий
A-HR10-235-90		szampan / champagne / шампань	
A-HR10-300-05	3000	aluminium / aluminium / алюминий	
A-HR10-300-10		biały / white / белый	
A-HR10-300-90		szampan / champagne / шампань	
A-HR10-405-05	4500	aluminium / aluminium / алюминий	
A-HR10-405-90		szampan / champagne / шампань	
A-HR10-600-05	6000	aluminium / aluminium / алюминий	
A-HR10-600-90		szampan / champagne / шампань	



Profil HRS10
Profile HRS10
Профиль HRS10







			
A-HRS10-170-05	1700	aluminium / aluminium / алюминий	aluminium aluminium алюминий
A-HRS10-300-05	3000	aluminium / aluminium / алюминий	
A-HRS10-300-90		szampan / champagne / шампань	
A-HRS10-405-05	4050	aluminium / aluminium / алюминий	
A-HRS10-600-05	6000	aluminium / aluminium / алюминий	



Profil HR10 FL
Profile HR10 FL
Профиль HR10 FL





	 mm		
A-HR10FL-300-05	3000	aluminium / aluminium / алюминий	aluminium aluminium алюминий
A-HR10FL-300-10		biały / white / белый	
A-HR10FL-300-90		szampan / champagne / шампань	



Prowadnik górny PG-18
Top roller PG-18
Верхний ролик PG-18





	 kg	
A-PG-18	50	stal, tworzywo steel, plastic сталь, пластмасса





Prowadnik górny PGR-18
Top roller PGR-18
Верхний ролик PGR-18



	 kg	
A-PGR-18	50	stal, tworzywo steel, plastic сталь, пластмасса





Prowadnik górny PGR-10
Top roller PGR-10
Верхний ролик PGR-10

		
A-PGR-10	50	stal, tworzywo steel, plastic сталь, пластмасса





Prowadnik górny PGR-10 symetryczny
Top roller PGR-10 symmetrical
Верхний ролик PGR-10 симметричный

		
A-PGR-10S	50	stal, tworzywo steel, plastic сталь, пластмасса





Płytk dystansowa
Spacer plate
Распорная пластина

		
A-DPG-16	50	stal steel сталь





Wózek dolny EVO 2
Bottom roller EVO 2
Нижний ролик EVO 2

		
A-WD-EVO2	50	stal / tworzywo steel / plastic сталь / пластмасса





Zaczep EVO 2
Hook EVO 2
Зацепка EVO 2

		
A-ZAC-WDEVO2	50	stal, tworzywo steel, plastic сталь, пластмасса





Wózek dolny PRO
Bottom roller PRO
Нижний ролик PRO

		
A-WD-PRO	50	stal, tworzywo steel, plastic сталь, пластмасса



Wózek dolny EVO rama
Bottom roller EVO frame
Нижний ролик EVO для рамной системы





		
A-WDR-EVO	50	stal, tworzywo steel, plastic сталь, пластмасса



Wózek dolny PRO rama
Bottom roller PRO frame
Нижний ролик PRO для рамной системы





		
A-WDR-PRO	50	stal, tworzywo steel, plastic сталь, пластмасса



Pozycjoner górny
Top positioner
Верхний стопор





		
A-PTG	50	tworzywo plastic пластмасса



Pozycjoner dolny PRO
Bottom positioner PRO
Нижний стопор PRO



		
A-PTD	50	stal steel сталь



Szczotka odbojowa 4,8 x 4
Buffer strip 4,8 x 4
Буферная щётка 4,8 x 4





		
A-SO-48X4	szary gray серый	tworzywo plastic пластмасса



Szczotka odbojowa szeroka 14,5 x 4
Buffer strip wide 14,5 x 4
Буферная щётка широкая 4,8 x 4



		
A-SO-145X4	szary / gray / серый	tworzywo plastic пластмасса
A-SO-145X4-10	biały / white / белый	
A-SO-145X4-20	czarny / black / чёрный	



Szczotka przeciwkurzowa bez kleju 4,8 x 7
 Anti-dust strip without glue 4,8 x 7
 Противопылевая щётка без клея 4,8 x 7



		
A-SP-48X7	szary gray серый	tworzywo plastic пластмасса



Szczotka przeciwkurzowa z klejem 7 x 12
 Anti-dust strip with glue 7 x 12
 Противопылевая щётка на клеевой основе 7 x 12



		
A-SP-7X12	szary gray серый	tworzywo plastic пластмасса



Szczotka przeciwkurzowa bez kleju 4,8 x 12
 Anti-dust strip without glue 4,8 x 12
 Противопылевая щётка 4,8 x 12 (вставная)



		
A-SP-48X12	szary gray серый	tworzywo plastic пластмасса



Klin do rączek
Wedge for handle
Клин для профиль-ручки



		
A-KR-4	biały white белый	tworzywo plastic пластмасса



Klin do listew poziomych
Wedge for horizontal strips
Клин для горизонтальных профилей





		
A-KLP-4	biały white белый	tworzywo plastic пластмасса



Klips do mocowania toru dolnego EVO 2
Mounting clip for bottom track EVO 2
Клипса для крепления нижней направляющей EVO 2







		
A-ZAT-TDEV02	mleczny milk молочный	tworzywo plastic пластмасса



Uszczelka typ U, średnio twarda
Gasket U, medium hard
Уплотнитель тип U, средней твердости







			
A-USZCZ-U4	100	przeźroczysty transparent прозрачный	tworzywo plastic пластмасса



Uszczelka typ CH, miękka
Seal type CH, soft
Уплотнитель типа CH, мягкий







			
A-USZCZ-CHM4	120	przeźroczysty transparent прозрачный	tworzywo plastic пластмасса



Uszczelka do toru dolnego EVO 2
Gasket for EVO 2 track
Уплотнитель для нижней направляющей EVO 2



			
A-USZCZ-TDEVO2	200	mleczny milk молочный	PVC



Blachowkręć 6,3 x 40
Steel metal screw 6,3 x 40
Сборочный винт 6,3 x 40

	
A-B63-40	stal steel сталь





Blachowkręć 6,3 x 32
Steel metal screw 6,3 x 32
Сборочный винт 6,3 x 32

	
A-B63-32	stal steel сталь





Spowalnicz SIMON skrajny
Internal soft closing damper SIMON
Боковой доводчик SIMON

		
A-SOFT-30	30	stal, tworzywo steel, plastic сталь, пластмасса
A-SOFT-50	50	



Spowalnicz SIMON środkowy
Internal soft closing damper SIMON
Центральный доводчик SIMON





		
A-MSOFT-RAMA	50	stal, tworzywo steel, plastic сталь, пластмасса



Zestaw adaptera do spowalnicza środkowego
Adapter set for soft closing damper
Адаптер для доводчика





		
A-MSOFT-ADAPT	50	stal steel сталь















Ręczny przyrząd wiertarski z dociskiem
Hand drilling tool with locking screws
Ручной сверлильный кондуктор с зажимом



	
A-PW-RC-DOC	stal steel сталь



MITO
MITO
MITO



			 L mm	 kg			
	Tor MITO Track MITO Направляющая MITO	A-TMITO-200-00	200	50			
		A-TMITO-250-00	250				
		A-TMITO-300-00	300				
		A-TMITO-200-05	200				
		A-TMITO-250-05	250				
		A-TMITO-300-05	300				
	Pozycjoner Positioner Стопор	A-POZ-MITO	-		szary gray серый	tworzywo plastic пластмасса	1000
	Wózek górny Top guide Верхний проводник	A-SG-MITO	-		ocynk zink оцинковка	stal, tworzywo steel, plastic сталь, пластмасса	100
	Wózek dolny z łożyskiem kulkowym Bottom roller with ball bearing Нижний ролик с шариковым подшипником	A-RD-MITO	-				



Zestaw MITO PLUS
MITO PLUS set
MITO PLUS комплект



2 wózki górne ze sprężyną, 2 wózki dolne z łożyskiem kulkowym, 1 pozycjoner, komplet wkrętów
2 top rollers with spring, 2 bottom ball bearing rollers, 1 positioner, set of screws
2 верхних проводника с пружиной, 2 нижних ролика с шариковым подшипником, 1 стопор, комплект шурупов

		 kg		
A-MITO-PLUS	50	ocynk / zink / оцинковка	stal / steel / сталь	



Zestaw OVERLINE
OVERLINE set
OVERLINE комплект



2 szt. wózków zewnętrznych, 2 szt. wózków wewnętrznych, 2 szt. pozycjonerów, 2 szt. prowadników dolnych ślizgowych drzwi zewnętrznych, 2 szt. prowadników dolnych ślizgowych drzwi wewnętrznych
2 external rollers, 2 internal rollers, 2 positioners, 2 bottom slides for external door, 2 bottom slides of internal door
Внешние ролики-2шт., внутренние ролики-2шт., нижние ходовые элементы внешней двери-2 шт., нижние ходовые элементы внутренней двери-2 шт., позиционер-2 шт.

A-SN-FSET	50	ocynk / zink / оцинковка	stal, tworzywo / steel, plastic / сталь, пластмасса	10	

	A-SN-R19RIV-270-05	-	aluminium aluminium алюминий	aluminium aluminium алюминий	24	
	A-SN-K19-270-05	-			48	
	A-C18-300-S-05	3000			50	
	A-SN-TG-405-00	4050	50	surowe aluminium raw aluminium сырой алюминий	stal steel сталь	80
	A-SN-TDS-405-00			aluminium aluminium алюминий	40	
	A-SN-SOFT-25	-	25	szary gray серый	tworzywo plastic пластмасса	100
	A-SN-SOFT-40	-	40			
	A-SN-ADSET	-	-	-	stal, tworzywo steel, plastic сталь, пластмасса	100



Zestaw OVERLINE PLUS
OVERLINE PLUS set
OVERLINE PLUS комплектация



2 szt. wózków zewnętrznych, 2 szt. wózków wewnętrznych, 2 szt. prowadników dolnych toczych drzwi zewnętrznych, 2 szt. prowadników dolnych toczych drzwi wewnętrznych, 1 zestaw wkrętów

2 external rollers, 2 internal rollers, 2 bottom slides for external door, 2 bottom slides for internal door, screws

Составляющие: внешние ролики – 2шт., внутренние ролики – 2шт., нижние ходовые элементы внешней двери – 2 шт., нижние ходовые элементы внутренней двери – 2 шт., 1 клп. шурупов

A-SN-HSET1	50	ocynk / zink / оцинковка	stal, tworzywo / steel, plastic / сталь, пластмасса	1			
	Rączka RIVA Handle RIVA Ручка RIVA	A-SN-R19RIV-270-05	2700	-		24	
	Profil C19 Handle C19 Ручка C19	A-SN-K19-270-05		-	aluminium aluminium алюминий	aluminium aluminium алюминий	48
	Profil C18 Handle C18 Ручка C18	A-C18-300-S-05	3000	-			50
	Tor górny Top track Верхняя направляющая	A-SN-TG-405-00	4050	-	surowe aluminium raw aluminium сырой алюминий	stal steel сталь	80
	Tor dolny Bottom track Нижняя направляющая	A-SN-TDT-405-00		-		aluminium aluminium алюминий	20
	Spowalnicz Soft closing damper доводчик	A-SN-SOFT-25	-	25	-	tworzywo plastic пластмасса	100
		A-SN-SOFT-40	-	40	-		
	Pozycjoner Positioner Стоп	A-SN-POZ	-	-	czarny black черный		20
	Zestaw do spowalnicza Soft closing damper set доводчик комплектация 1 szt. aktywator drzwi zewn. i 1 szt. wewn., 4 szt. adapterów, 1 zestaw wkrętów 1 pc activator outer door and 1 pc inner door, 4 pcs adapter, 1 screw set активатор внеш. двери - 1 шт., активатор внутр. двери - 1 шт., адаптер - 4 шт., 1 клп. шурупов	A-SN-ADSET	-	-	-	stal, tworzywo steel, plastic сталь, пластмасса	100

Prostownica Warped door straightener Стяжка-выпрямитель



2 szt. listwy ściągające, 2 szt. płytki naciągające, 4 szt. płytki dociskowej, zaślepka, tuleja pozycjonująca, klucz do regulacji
Tightening strip - 2 pcs, tensioning plate - 2 pcs, pressure plate - 4 pcs, cover cap, positioning sleeve, adjustment spanner
Планка с резьбой - 2 шт., натяжная пластина - 2 шт., прижимная пластина - 4 шт., заглушка, зажимная гильза, ключ для регулировки



A-SN-SDP-TU

50

ocynk / zink / оцинковка

stal, tworzywo / steel, plastic / сталь, пластмасса



Zestaw QUANTUM
 QUANTUM set
 Комплект QUANTUM



2 szt. wózków, 2 szt. stoperów, 2 szt. przewodników, komplet wkrętów
 Rollers - 2 pcs, stoppers - 2 pcs, guide - 2 pcs, screw set
 Ролики - 2 шт., стопор - 2 шт., проводник - 2 шт., комплект шурупов

A-BUDP-SET	50	aluminium / aluminium / алюминий	stal, tworzywo / steel, plastic / сталь, пластмасса	24

			mm	kg			
	Tor górny Top track Верхняя направляющая	A-TG-BUD-200-00	2000	50	surowe aluminium raw aluminium сырой алюминий	aluminium aluminium алюминий	15
		A-TG-BUD-300-00	3000				
	Uchwyt boczny Side holder Боковое крепление	A-BUD-UB	-		ocynk zink оцинковка	stal steel сталь	200
	Uchwyt górny Top holder Верхнее крепление	A-BUD-UG	-		aluminium aluminium алюминий	aluminium aluminium алюминий	250
	Uchwyt maskownicy toru górnego Top track masking cover holder Держатель декоративной панели	A-BUD-UM	60		szary gray серый	stal, tworzywo steel, plastic сталь, пластмасса	100
	Uchwyt do ramy (4 szt.) Frame holder (4 pcs) Крепление плиты (4 шт.)	A-BUD-UR	-		ocynk zink оцинковка	stal steel сталь	
	Uchwyt do płyty Board holder Держатель для плиты	A-BUD-UP	-				



Zestaw LOFT
LOFT set
Комплект LOFT



2 szt. wózków, prowadnik, tor 2 m, 5 sztuk tulei dystansowych, 2 szt. odbojników, 2 szt. zabezpieczeń przed wypadnięciem drzwi, 2 szt. spawalniaczy, 2 szt. aktywatorów, komplet wkrętów i śrub

Roller – 2 pcs, slide – 1 pc, track 2 m, distance sleeve – 5 pcs, bumper 2 pcs, stopper preventing door from falling out – 2 pcs, soft closing damper – 2 pcs, activator – 2 pcs, screw set

Ролик – 2 шт., проводник – 1 шт., Направляющая 2 м, Амортизатор – 2 шт., блокада – 2 шт., доводчик – 2 шт., активатор – 2 шт., кпл. шурупов



A-SN-LOFT-200-20M	100	czarny / black / чёрный	stal, tworzywo / steel, plastic / сталь, пластмасса	1
-------------------	-----	-------------------------	---	---



ÓŚWIETLENIE MEBLOWE FURNITURE LIGHTING МЕБЕЛЬНОЕ ОСВЕЩЕНИЕ

Taśmy LED LED strips Светодиодные ленты	456 – 458
Profile LED LED profiles Профили LED	459 – 486
Oprawy LED LED fittings Светодиодные светильники	487 – 501
Akcesoria Accessories Аксессуары	502 – 529
Przedłużacze biurkowe Desk power sockets Выдвижные удлинители	530 – 545





ТаЅма LED FLASH
LED strip FLASH
Светодиодная лента FLASH



LD-3528-300-20-ZB	12 VDC 24 W	300 lm/m	● 6500 K	20	120°	5	8	60/m	5		
LD-3528-300-20-NE4P			● 4000 K								
LD-3528-300-20-CB			● 3200 K								
LD-3528-300-65-ZB		● 6500 K	65								
LD-3528-300-65-CB		● 3200 K									
LD-3528-300-20-NI	-	niebieski / blue / синий	20								
LD-3528-600-20-ZB	12 VDC 48 W	550 lm/m	● 6500 K	20			120/m	2,5			
LD-3528-600-20-CB		520 lm/m	● 3200 K	65							
LD-3528-600-65-ZB			● 6500 K								
LD-3528-600-65-CB	● 3200 K										
LD-2835-300-20-ZB	12 VDC 30 W	750 lm/m	● 6500 K	20	5	8			60/m	5	
LD-2835-300-20-NE4P			● 4000 K								
LD-2835-300-20-CB			● 3200 K								
LD-2835-300-65-ZB		700 lm/m	● 6500 K	65							
LD-2835-300-65-CB			● 3200 K								
LD-2835-300-20-ZBN	12 VDC 33 W	850 lm/m	● 6500 K	20							10
LD-2835-300-20-NE4N			● 4000 K								
LD-2835-300-20-CBN			● 3200 K								
LD-2835-300-65-ZBN		730 lm/m	● 6500 K	65							
LD-2835-300-65-NE4N			● 4000 K								
LD-2835-300-65-CBN	● 3200 K										
LD-2835-600-20-ZB	12 VDC 60 W	1600 lm/m	● 6500 K	20	65	10	120/m	2,5			
LD-2835-600-20-NE4			● 4000 K								
LD-2835-600-20-CB			● 3200 K								
LD-2835-600-65-ZB		1350 lm/m	● 6500 K	65							
LD-2835-600-65-CB			● 3200 K								





LD-2835-600-20-ZB	12 VDC 60 W	1600 lm/m	● 6500 K	20	120°	5	10	120/m	2,5				
LD-2835-600-20-NE4			● 4000 K										
LD-2835-600-20-CB			● 3200 K										
LD-2835-600-65-ZB		● 6500 K	65										
LD-2835-600-65-CB		● 3200 K											
LD-2835-600-5MM-20-ZB	12 VDC 33 W	750 lm/m	● 6500 K	20			120°	5	5	120/m	2,5		
LD-2835-600-5MM-20-NE4			● 4000 K										
LD-2835-600-5MM-20-CB			● 3200 K										
LD-2835-60-60-20-CCT	12 VDC 30 W	700 lm/m	● 3200 K ● 6500 K	20					120°	5	8	120/m	5
LD-5050-300-20-ZB	12 VDC 72 W	900 lm/m	● 6500 K	65									
LD-5050-300-20-CB			● 3200 K										
LD-5050-300-65-ZB		850 lm/m	● 6500 K										
LD-5050-300-65-CB			● 3200 K										
LD-5630-300-20-ZB	12 VDC 80 W	1750 lm/m	● 6500 K	20	120°	5	10	60/m	5				
LD-5630-300-20-CB			● 3200 K										
LD-5630-300-65-ZB		1700 lm/m	● 6500 K										
LD-5630-300-65-CB			● 3200 K										
LD-3014-1200-20-ZB	12 VDC 53 W	1300 lm/m	● 6500 K	20			120°	5	240/m	1,25			
LD-3014-1200-20-NE4			● 4000 K										
LD-3014-1200-20-CB			● 3200 K										
LD-RGB-150-20	12 VDC 36 W	450 lm/m	● RGB	65	120°	5			30/m	10			
LD-RGB-150-65			● RGB										



ТаЅма LED FLASH 24V
LED strip FLASH 24V
Светоодиодная лента FLASH 24V

NEW



LD-2835-24V-300-20-CB	24 VDC 48 W	1100 lm/m	● 3200 K	20	120°	5 m	8 mm	60/m	10	
LD-2835-24V-300-20-ZB			● 6500 K							
LD-2835-24V-300-20-NE4			● 4000 K							
LD-2835-24V-600-20-CB	24 VDC 78 W	1900 lm/m	● 3200 K				10 mm	120/m		5
LD-2835-24V-600-20-ZB			● 6500 K							
LD-2835-24V-600-20-NE4			● 4000 K							



ТаЅма LED FLASH 50 m
LED strip FLASH 50 m
Светоодиодная лента FLASH 50 m



LD-2835-300-20-ZB-50	12 VDC 6 W/m	750 lm/m	● 6500 K	20	120°	8 mm	60/m	5			
LD-2835-300-20-NE4P-50			● 4000 K								
LD-2835-300-20-CB-50			● 3200 K								
LD-3528-300-20-ZB-50	12 VDC 4,8 W/m	300 lm/m	● 6500 K						10 mm	120/m	5
LD-3528-300-20-NE4P-50			● 4000 K								
LD-3528-300-20-CB-50			● 3200 K								



Profil GLAX liniowy
GLAX linear profile
Профиль GLAX линейный

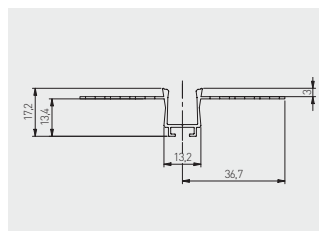
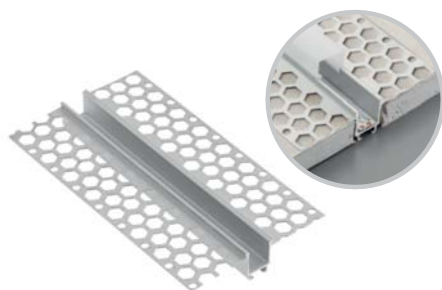

PA-GLAXGKL3M-00	3	profil / profile / профиль		aluminium aluminium алюминий	
PA-CPGLAXL-00	-	łącznik liniowy connector straight лінійний з'єднувач		srebrny silver серебристый	stal nierdzewna stainless steel нержавеющая сталь
PA-CPGLAXAH-00	-	łącznik poziomy connector horizontal горизонтальный з'єднувач			
PA-CPGLAXAV-00	-	łącznik pionowy connector vertical вертикальний з'єднувач			
PA-OSMLGLAXM3M-00	3	ostonka / cover / крышка		PC	
PA-OSMLGLAXMK3M-00	3	ostonka kwadratowa cover square крышка квадратная			
PA-OSMLGLAXM03M-00	3	ostonka okrągła cover round крышка круглая			
PA-OSMLGLAXT3M-00	3	ostonka trójkątna cover triangular крышка треугольная			

Ostonki / Covers / Крышки



Akcesoria / Accessories / Аксессуары



PA-OSMLGLAXM3M-00 PA-OSMLGLAXMK3M-00 PA-OSMLGLAXM03M-00 PA-OSMLGLAXT3M-00

Profil GLAX ścienny
GLAX wall profile
Профиль GLAX настенный

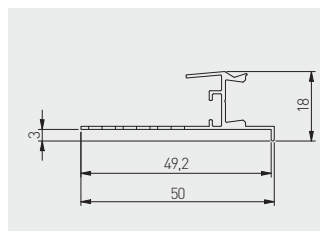
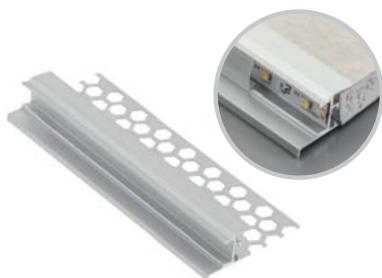

PA-GLAXGKS3M-00	3	profil / profile / профиль	srebrny silver серебристый	aluminium aluminium алюминий
PA-CPGLAXL-00	-	łącznik liniowy connector straight лінійний з'єднувач		stal nierdzewna stainless steel нержавеющая сталь
PA-CPGLAXAH-00	-	łącznik poziomy connector horizontal горизонтальний з'єднувач		
PA-CPGLAXAV-00	-	łącznik pionowy connector vertical вертикальний з'єднувач		
PA-OSMLGLAXM3M-00	3	osłonka / cover / крышка	mleczna frosted молочная	PC
PA-OSMLGLAXMK3M-00	3	osłonka kwadratowa cover square крышка квадратная		
PA-OSMLGLAXM03M-00	3	osłonka okrągła cover round крышка круглая.		
PA-OSMLGLAXT3M-00	3	osłonka trójkątna cover triangular крышка треугольная		

Ostonki / Covers / Крышки



Aksesoria / Accessories / Аксессуары



PA-CPGLAXL-00 PA-CPGLAXAH-00 PA-CPGLAXAV-00

PA-OSMLGLAXM3M-00 PA-OSMLGLAXMK3M-00 PA-OSMLGLAXM03M-00 PA-OSMLGLAXT3M-00

Profil GLAX sufitowy
GLAX ceiling profile
Профиль GLAX потолочный

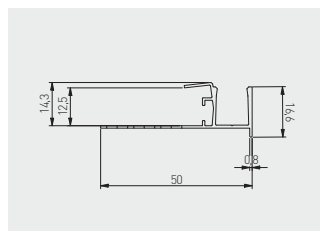
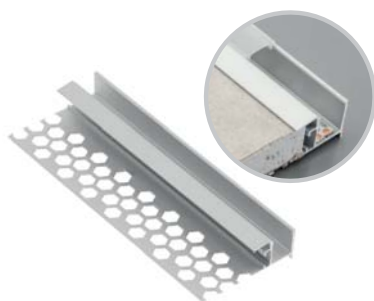

PA-GLAXGKW3M-00	3	profil / profile / профиль	srebrny silver серебристый	aluminium aluminium алюминий
PA-CPGLAXL-00	-	łącznik liniowy connector straight лінійний з'єднувач		stal nierdzewna stainless steel нержавеющая сталь
PA-CPGLAXAH-00	-	łącznik poziomy connector horizontal горизонтальний з'єднувач		
PA-CPGLAXAV-00	-	łącznik pionowy connector vertical вертикальний з'єднувач		
PA-OSMLGLAXM3M-00	3	osłonka / cover / крышка	mleczna frosted молочная	PC
PA-OSMLGLAXMK3M-00	3	osłonka kwadratowa cover square крышка квадратная		
PA-OSMLGLAXM03M-00	3	osłonka okrągła cover round крышка круглая		
PA-OSMLGLAXT3M-00	3	osłonka trójkątna cover triangular крышка треугольная		

Ostonki / Covers / Крышки



Aksesoria / Accessories / Аксессуары



PA-OSMLGLAXM3M-00 PA-OSMLGLAXMK3M-00 PA-OSMLGLAXM03M-00 PA-OSMLGLAXT3M-00

Profil GLAX kątowy, wewnętrzny
GLAX internal angle profile
Профиль GLAX угловой внутренний

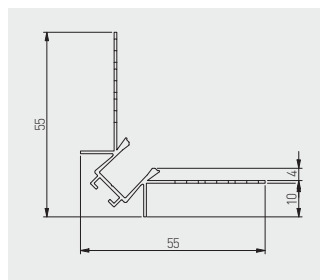

PA-GLAXGKWK3M-00	3	profil / profile / профиль	srebrny silver серебристый	aluminium aluminium алюминий
PA-CPGLAXL-00	-	łącznik liniowy connector straight лінійний з'єднувач		stal nierdzewna stainless steel нержавеющая сталь
PA-CPGLAXAH-00	-	łącznik poziomy connector horizontal горизонтальный з'єднувач		
PA-CPGLAXAV-00	-	łącznik pionowy connector vertical вертикальний з'єднувач		
PA-OSMLGLAXM3M-00	3	ostonka / cover / крышка	mleczna frosted молочная	PC
PA-OSMLGLAXMK3M-00	3	ostonka kwadratowa cover square крышка квадратная		
PA-OSMLGLAXM03M-00	3	ostonka okrągła cover round крышка круглая		
PA-OSMLGLAXT3M-00	3	ostonka trójkątna cover triangular крышка треугольная		

Ostonki / Covers / Крышки



PA-OSMLGLAXM3M-00 PA-OSMLGLAXMK3M-00 PA-OSMLGLAXM03M-00 PA-OSMLGLAXT3M-00

Aksesoria / Accessories / Аксессуары



PA-CPGLAXL-00 PA-CPGLAXAH-00 PA-CPGLAXAV-00



Profil GLAX kątowy, zewnętrzny
GLAX external angle profile
Профиль GLAX угловой внешний

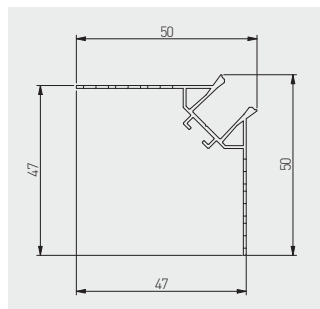

PA-GLAXGKZK3M-00	3	profil / profile / профиль	srebrny silver серебристый срібний	aluminium aluminium алюминий
PA-CPGLAXL-00	-	łącznik liniowy connector straight лінійний з'єднувач		
PA-CPGLAXAH-00	-	łącznik poziomy connector horizontal горизонтальний з'єднувач		
PA-CPGLAXAV-00	-	łącznik pionowy connector vertical вертикальний з'єднувач		
PA-OSMLGLAXM3M-00	3	ostonka / cover / крышка	mleczna frosted молочная	PC
PA-OSMLGLAXMK3M-00	3	ostonka kwadratowa cover square крышка квадратная		
PA-OSMLGLAXM03M-00	3	ostonka okrągła cover round крышка круглая		
PA-OSMLGLAXT3M-00	3	ostonka trójkątna cover triangular крышка треугольная		

Ostonki / Covers / Крышки



Aksesoria / Accessories / Аксессуары



PA-CPGLAXL-00

PA-CPGLAXAH-00

PA-CPGLAXAV-00

PA-OSMLGLAXM3M-00

PA-OSMLGLAXMK3M-00

PA-OSMLGLAXM03M-00

PA-OSMLGLAXT3M-00

Profil GLAX nakładany, mikro
 GLAX profile surface mounted, micro
 Профиль GLAX накладной, микро

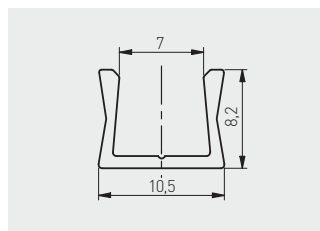
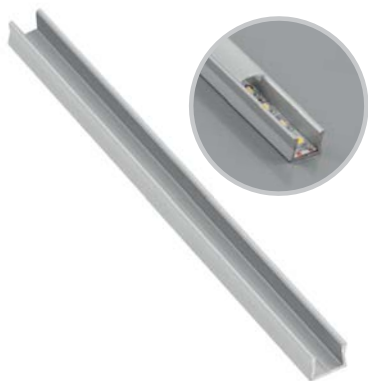

Wąska linia światła.
 Brak punktów świetlnych przy użyciu
 dedykowanej taśmy LED o szerokości 5 mm.
 Narrow line of light.
 No visible points of light due to dedicated
 5mm LED strip.
 Узкая линия света.
 Отсутствуют пункты свечения при
 использовании специальной ленты LED
 с шириной 5 мм.

				
PA-GLAXMICNK-AL	2	profil profile профиль	srebrny silver серебристый	aluminium aluminium алюминий
PA-GLAXMICNK3M-AL	3			
PA-OSMLGLAXMIC-00	2	ostonka mikro cover micro крышка микро	mleczna frosted молочная	PC
PA-OSMLGLAXMIC3M-00	3			
PA-ZASGLAXMICNK-00	-	zaślepka end cap заглушка	szary gray серый	ABS
PA-SPRGLAXMIC-00	-	uchwyt mounting clip держатель	srebrny silver серебристый	stal nierdzewna stainless steel нержавеющая сталь



Profil GLAX nakładany mini
 GLAX profile mini surface mounted
 Профиль GLAX накладной мини

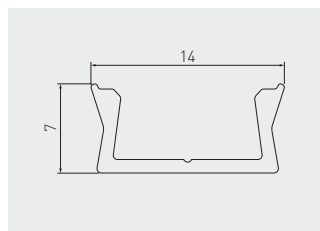

Taśma LED max. 10 mm szerokości
 LED strip width max 10 mm
 Ширина светодиодной ленты не более 10 мм



PA-GLAXMNX-AL	2	profil profile профиль	srebrny / silver / серебристый	aluminium aluminium алюминий
PA-GLAXMNX-AL-20M			czarny / black / черный	
PA-GLAXMNX-AL-10			biały / white / белый	
PA-GLAXMNX-AL-90			szampański / champagne / шампань	
PA-GLAXMNX3M-AL			srebrny / silver / серебристый	
PA-GLAXMNX3M-AL-20M			czarny / black / черный	
PA-GLAXMNX3M-AL-10	3	ostonka mini cover mini крышка мини	biały / white / белый	PC
PA-OSMLGLAXM-00			mleczna / frosted / молочная	
PA-OSMLGLAXM3M-00			transparentna / transparent прозрачная	
PA-OSTRGLAXM-00	2	ostonka kwadratowa cover square крышка квадратная	mleczna / frosted / молочная	ABS
PA-OSTRGLAXM3M-00	3			
PA-OSMLGLAXMO-00	2			
PA-ZASGLAXMNX-00	-	zaślepka standard end cap standard заглушка стандартная	szary / gray / серый	ABS
PA-ZASGLAXMNX-10			biały / white / белый	
PA-ZASGLAXMNX-90			szampański / champagne / шампань	
PA-ZASGLAXMNX-20M			czarny mat / black matt / чёрный матовый	
PA-ZASGLAXMNXK-00	-	zaślepka kwadratowa end cap square заглушка квадратная	szary / gray / серый	stal nierdzewna stainless steel нержавеющая сталь
PA-ZASGLAXMNKO-00	-	zaślepka okrągła end cap round заглушка круглая	szary / gray / серый	
PA-SPRGLAXM-00	-	uchwyt mounting clip держатель	srebrny / silver / серебристый	

Ostonki / Covers / Крышки

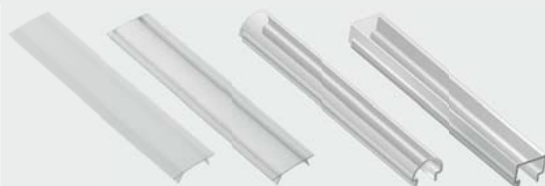
 PA-OSMLGLAXM-00
 PA-OSMLGLAXM3M-00

 PA-OSTRGLAXM-00
 PA-OSTRGLAXM3M-00

PA-OSMLGLAXMO-00

PA-OSMLGLAXMK-00

Zaślepki / End caps / Заглушки



PA-ZASGLAXMNX-00

PA-ZASGLAXMNXK-00

 Uchwyt
 mounting clip
 держатель

PA-ZASGLAXMNKO-00

PA-SPRGLAXM-00

Profil GLAX nakładany
GLAX profile surface mounted
Профиль GLAX накладной

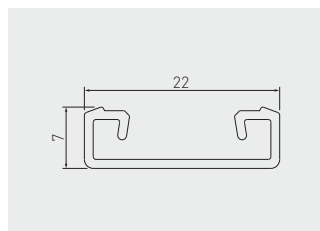

PA-GLAXNK-AL	2	profil profile профиль		aluminium aluminium алюминий
PA-GLAXNK3M-AL	3			
PA-OSMLGLAX-00	2	ostonka cover крышка		PC
PA-OSMLGLAX3M-00	3			
PA-OSTRGLAX-00	2			
PA-OSTRGLAX3M-00	3			
PA-ZASGLAXNK-00	-	zaślepka end cap заглушка		ABS



Profil GLAX nakładany mini, wysoki
 Profile GLAX surface mounted mini, high
 Профиль GLAX накладной мини, высокий

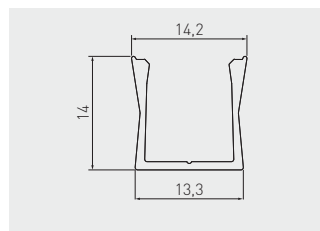

Brak widocznych punktów świetlnych.
 Taśma LED max 10 mm szerokości.
 No visible points of light.
 LED strip width max 10 mm.
 Нет видимых точек света.
 Ширина светодиодной ленты не более 10 мм.

PA-GLAXMNKW-AL	2	profil profile профиль	srebrny / silver / серебристый	aluminium aluminium алюминий	
PA-GLAXMNKW-AL-20M			czarny / black / черный		
PA-GLAXMNKW-AL-10			biały / white / белый		
PA-GLAXMNKW-AL-90			szampan / champagne / шампань		
PA-OSMLGLAXM-00	2	ostonka mini cover mini крышка мини	mleczna / frosted / молочная	tworzywo plastic пластик	
PA-OSTRGLAXM-00			transparentna / transparent / прозрачная		
PA-ZASGLAXMNKW-00	-	zaślepka end cap заглушка	szary / gray / серый	ABS	
PA-ZASGLAXMNKW-10			biały / white / белый		
PA-ZASGLAXMNKW-90			szampan / champagne / шампань		
PA-ZASGLAXMNKW-20M			czarny mat / black matt / чёрный матовый		
PA-SPRGLAXM-00	-	uchwyt mounting clip держатель	srebrny / silver / серебристый		



Profil GLAX wpuszczany, mikro
 GLAX profile recessed, micro
 Профиль GLAX врезной, микро

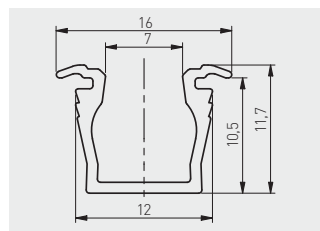

Wąska linia światła.
 Brak punktów świetlnych przy użyciu
 dedykowanej taśmy LED o szerokości 5 mm.
 Narrow line of light.
 No visible points of light due to dedicated
 5mm LED strip.
 Узкая линия света.
 Отсутствуют пункты свечения при
 использовании специальной ленты LED
 с шириной 5 мм.

PA-GLAXMIC-AL	2	profil profile профиль	srebrny silver серебристый	aluminium aluminium алюминий
PA-GLAXMIC3M-AL	3			
PA-OSMLGLAXMIC-00	2	ostonka mikro cover micro крышка микро	mleczna frosted молочная	PC
PA-OSMLGLAXMIC3M-00	3			
PA-ZASGLAXMIC-00	-	zaślepka end cap заглушка	szary gray серый	ABS

Ostonki / Covers / Крышки



PA-OSMLGLAXMIC3M-00

Zaślepki / End caps / Заглушки



PA-ZASGLAXMIC-00

Profil GLAX wpuszczany
 Profile GLAX recessed
 Профиль LED GLAX врезной

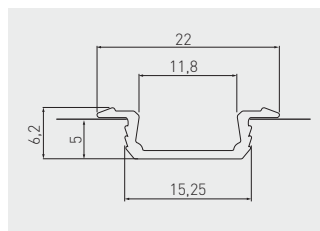

PA-GLAX-AL	2	profil profile профиль	srebrny / silver / серебристый	aluminium aluminium алюминий
PA-GLAX-AL-20M			czarny / black / черный	
PA-GLAX-AL-10			biały / white / белый	
PA-GLAX-AL-90			szampan / champagne / шампань	
PA-GLAX3M-AL	3		srebrny / silver / серебристый	
PA-OSMLGLAX-00	2	ostonka cover крышка	mleczna frosted молочная	PC
PA-OSMLGLAX3M-00	3			
PA-OSTRGLAX-00	2		transparentna transparent прозрачная	
PA-OSTRGLAX3M-00	3			
PA-ZASGLAX-00	-	zaślepka end cap заглушка	szary / gray / серый	ABS
PA-ZASGLAX-10			biały / white / белый	
PA-ZASGLAX-90			szampan / champagne / шампань	
PA-ZASGLAX-20M			czarny mat / black matt / чёрный матовый	



Profil GLAX wpuszczany, wysoki
 Profile GLAX recessed, high
 Профиль LED GLAX врезной

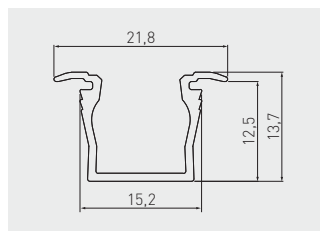

Brak widocznych punktów świetlnych.
Taśma LED max. 10 mm szerokości.

No visible points of light.
LED strip width max 10 mm.

Нет видимых точек света.
Ширина светодиодной ленты
не более 10 мм.

PA-GLAXMW-AL	2	m	profil profile профиль	srebrny / silver / серебристый	aluminium aluminium алюминий
PA-GLAXMW-AL-20M				czarny / black / черный	
PA-GLAXMW-AL-10				biały / white / белый	
PA-GLAXMW-AL-90				szampan / champagne / шампань	
PA-OSMLGLAXM-00	2	m	ostonka mini cover mini крышка мини	mleczna frosted молочная	PC
PA-OSMLGLAXMK-00			ostonka kwadratowa cover square крышка квадратная		
PA-OSTRGLAXM-00			ostonka mini cover mini крышка мини	transparentna transparent прозрачная	
PA-ZASGLAXMW-00	-	m	zaślepka standard end cap standard заглушка стандартная	szary / gray / серый	ABS
PA-ZASGLAXMW-10				biały / white / белый	
PA-ZASGLAXMW-90				szampan / champagne / шампань	
PA-ZASGLAXMW-20M				czarny mat / black matt / чёрный матовый	
PA-ZASGLAXMWK-00	-	m	zaślepka kwadratowa end cap square заглушка квадратная	szary / gray / серый	

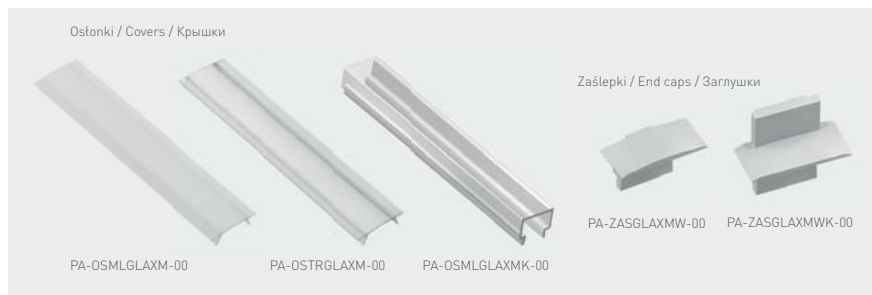

Profil GLAX kątowy
GLAX corner profile
Профиль GLAX угловой

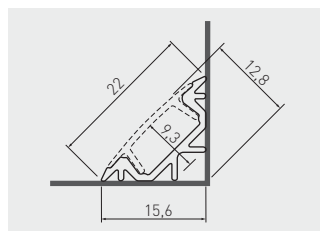

PA-GLAXKT-AL	2	profil profile профиль	srebrny silver серебристый	aluminium aluminium алюминий
PA-GLAXKT3M-AL	3			
PA-OSMLGLAX-00	2	ostonka cover крышка	mleczna frosted молочная	PC
PA-OSMLGLAX3M-00	3			
PA-OSTRGLAX-00	3			
PA-OSTRGLAX3M-00	2	transparentna transparent прозрачная		
PA-ZASGLAXKT-00	-	zaślepka end cap заглушка	szary gray серый	ABS

Ostonki / Covers / Крышки



PA-OSMLGLAX-00
PA-OSMLGLAX3M-00

PA-OSTRGLAX-00
PA-OSTRGLAX3M-00

Zaślepka / End cap / Заглушка





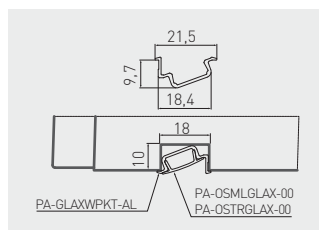

PA-ZASGLAXKT-00

Profil GLAX kątowy, wpuszczany
 Recessed corner profile GLAX
 Профиль GLAX угловой, врезной



Kąt świecenia 22°
 Beam angle 22°
 Угол свечения 22°

	 L m			
PA-GLAXWPKT-AL	2	profil profile профиль	srebrny silver серебристый	aluminium aluminium алюминий
PA-OSMLGLAX-00		ostonka cover крышка	mleczna frosted молочная	PC
PA-OSTRGLAX-00			transparentna transparent прозрачная	

Ostonki / Covers / Крышки



PA-OSMLGLAX-00



PA-OSTRGLAX-00

Profil GLAX kątowy, nakładany
GLAX aluminium corner profile – surface mounted
Профиль LED GLAX угловой, накладной

meble
2019 plus
PRODUKT Roku

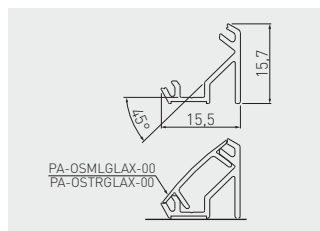

PA-GLAXNKKT-AL	2	profil profile профиль	srebrny / silver / серебристый	aluminium aluminium алюминий	
PA-GLAXNKKT-AL-20M			czarny / black / черный		
PA-GLAXNKKT-AL-10			biały / white / белый		
PA-GLAXNKKT-AL-90			szampan / champagne / шампань		
PA-GLAXNKKT3M-AL	3		srebrny / silver / серебристый		
PA-OSMLGLAX-00	2	osłonka cover крышка	mleczna frosted молочная	PC	
PA-OSMLGLAX3M-00	3		transparentna transparent прозрачная		
PA-OSTRGLAX-00	2				
PA-OSTRGLAX3M-00	3				
PA-OSMLGLAXT-00	2	osłonka trójkątna cover triangular крышка треугольная	mleczna frosted молочная		
PA-ZASGLAXNKKT-00	-	zaślepka standard end cap standard заглушка стандартная	szary / gray / серый	ABS	
PA-ZASGLAXNKKT-10			biały / white / белый		
PA-ZASGLAXNKKT-90			szampan / champagne / шампань		
PA-ZASGLAXNKKT-20M			czarny mat / black matt / чёрный матовый		
PA-ZASGLAXNKKT-00		zaślepka trójkątna end cap triangular заглушка треугольная	szary / gray / серый		
PA-SPRGLAXMIC-00	-	uchwyt mounting clip держатель	srebrny / silver / серебристый	stal nierdzewna stainless steel нержавеющая сталь	

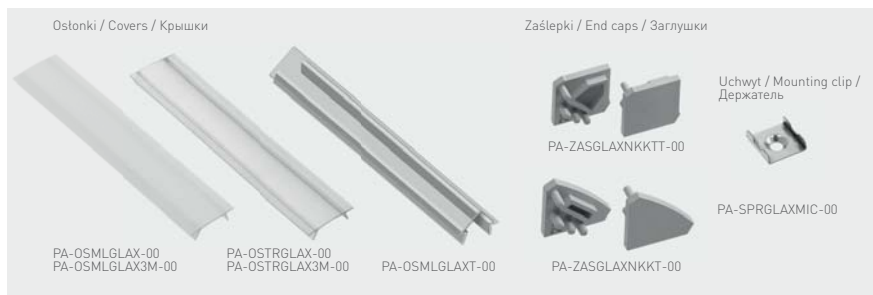

Profil GLAX z radiatorem
 Profile GLAX with heatsink
 Профиль GLAX с радиатором

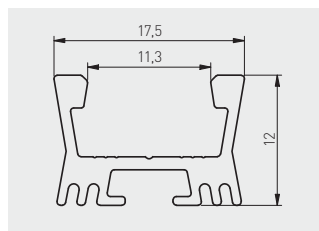

Dedykowana soczewka zawężająca kąt
 świecenia do 60°.

Możliwość zawieszenia oprawy za pomocą linek.
 Dedicated lens that narrow the beam angle
 to 60°.

Possibility to suspend the fixture using lines.
 Специальная линза, сужающая угол свечения
 до 60°.





Возможность монтажа с помощью
 крепления-тросика.

PA-GLAXRAD-AL	2	profil / profile / профиль	srebrny silver серебристый	aluminium aluminium алюминий
PA-OSMLGLAXSO-00	2	ostonka soczewka cover lenticular крышка линзовидный	transparentna transparent прозрачная	PMMA
PA-OSMLGLAX-00	2	ostonka cover крышка	mleczna frosted молочная	PC
PA-OSTRGLAX-00			transparentna transparent прозрачная	
PA-ZASGLAXRAD-00	-	zaślepka end cap заглушка	szary / gray / серый	ABS
PA-ZAWGLAXDR-00	1,5	zawieszka hanger подвес для профиля	chrom chrome хром	stal nierdzewna stainless steel нержавеющая сталь
PA-SPRGLAXM-00	-	uchwyt mounting clip держатель	srebrny / silver / серебристый	

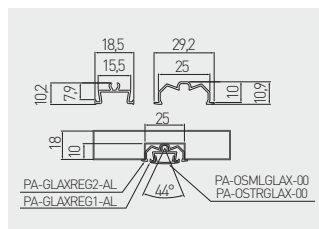

Profil GLAX z regulowanym kątem
 Profile GLAX with adjustable angle
 Профиль GLAX с регулировкой угла



				
PA-GLAXREG1-AL	2	profil profile профиль	srebrny silver серебристый	aluminium aluminium алюминий
PA-GLAXREG2-AL				
PA-OSMLGLAX-00	2	osłonka cover крышка	mleczna frosted молочная	PC
PA-OSTRGLAX-00			transparentna transparent прозрачная	

Ostonki / Covers / Крышки



PA-OSMLGLAX-00



PA-OSTRGLAX-00

Profil GLAX wieńcowy
Rim profile GLAX
Профиль GLAX, торцевой

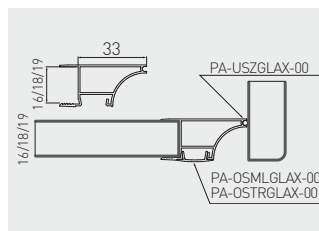

PA-GLAXWN-AL	18	2	profil profile профиль	srebrny silver серебристый	aluminium aluminium алюминий
PA-GLAXWN16-AL	16				
PA-GLAXWN19-AL	19				
PA-OSMLGLAX-00	-	2	ostonka cover крышка	mleczna frosted молочная	PC
PA-OSTRGLAX-00				transparentna transparent прозрачная	
PA-USZGLAX-00N	-	10	uszczelka cord gasket уплотнитель	czarny / black / чёрный	EPDM
PA-USZGLAX-10N	-			biały / white / белый	



Profil GLAX półkowy mini
Shelf profile GLAX mini
Профиль GLAX полочный мини

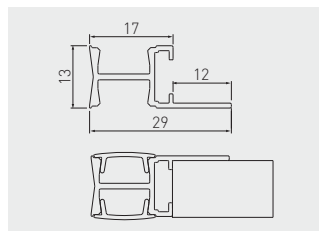

Możliwość zastosowania 3 taśm LED.
Possibility of using 3 LED strips.
Возможность использования 3 светодиодных лент.

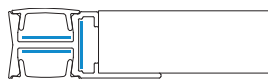

PA-GLAXMPK-AL	2	profil profile профиль	srebrny silver серебристый	aluminium aluminium алюминий
PA-OSMLGLAXM-00		ostonka mini cover mini крышка мини	mleczna frosted молочная	PC
PA-OSTRGLAXM-00		transparentna transparent прозрачная		

Ostonki / Covers / Крышки



PA-OSMLGLAXM-00



PA-OSTRGLAXM-00

Profil GLAX drążkowy
GLAX rail profile
Профиль-штанга GLAX

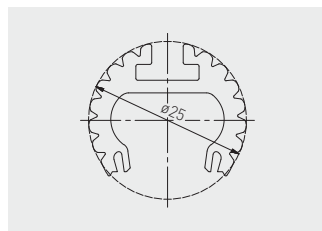

Możliwości montażu jako:

Assembly options as:

Варианты сборки:

- drążek w szafie
- oprawa zwieszana
- rod in the closet
- suspended luminaire
- стержень в шкафу
- подвесной светильник

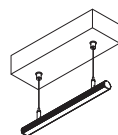
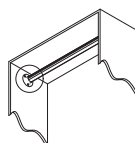

PA-GLAXDR-AL	2	profil profile профиль	srebrny silver серебристый	aluminium aluminium алюминий
PA-OSMLGLAX-00		ostonka cover крышка	mleczna frosted молочная	PC
PA-OSTRGLAX-00			transparentna transparent прозрачная	
PA-ZASGLAXDR-00	-	zaślepka end cap заглушка	szary gray серый	ABS
PA-ROZGLAX-53	-	rozetka rail socket монтажный крепеж		ZnAl
PA-ROZGLAXP-53	-	rozetka PREMIUM rail socket PREMIUM монтажный крепеж PREMIUM		
PA-ZAWGLAXDR-00	1,5	zawieszka hanger подвес для профиля	chrom chrome хром	stal steel сталь



Profil GLAX cokołowy jednostronny
 GLAX aluminium edge profile – single-sided
 Профиль LED GLAX торцевой, односторонний

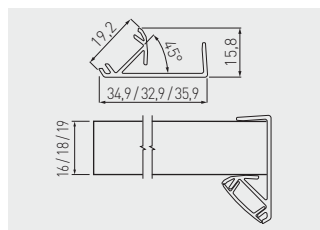

PA-GLAXNB3M16-AL	16	3	profil profile профиль	srebrny silver серебристый	aluminium aluminium алюминий
PA-GLAXNB3M-AL	18	3			
PA-GLAXNB3M19-AL	19	3			
PA-OSMLGLAX3M-00	-	3	ostonka cover крышка	mleczna frosted молочная	PC
PA-OSTRGLAX3M-00	-	3		transparentna transparent прозрачная	

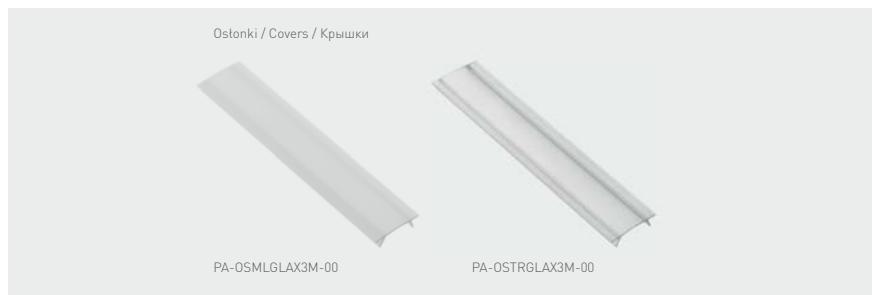

Profil GLAX cokołowy jednostronny, do wypełnienia obrzeżem
 GLAX aluminium edge profile – single-sided, option to fill with matching edge banding
 Профиль LED GLAX торцевой, односторонний, кромочный, двухсторонний

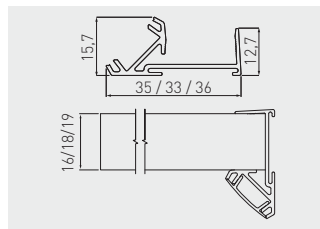

	BOARD mm	L mm			
PA-GLAXNBW3M16-AL	16	3	profil profile профиль	srebrny silver серебристый	aluminium aluminium алюминий
PA-GLAXNBW3M3-AL	18	3			
PA-GLAXNBW3M19-AL	19	3			
PA-OSMLGLAX3M-00	-	3	ostonka cover крышка	mleczna frosted молочная	PC
PA-OSTRGLAX3M-00	-	3		transparentna transparent прозрачная	



Profil GLAX przegrodowy dwustronny
 GLAX aluminium edge profile – double sided
 Профиль LED GLAX разделительный, двухсторонний

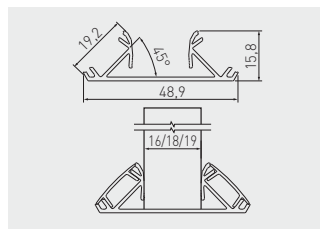

	BOARD mm	L m			
PA-GLAXNBD3M16-AL	16	3	profil profile профиль	srebrny silver серебристый	aluminium aluminium алюминий
PA-GLAXNBD3M-AL	18	3			
PA-GLAXNBD3M19-AL	19	3			
PA-OSMLGLAX3M-00	-	3	ostonka cover крышка	mleczna frosted молочная	PC
PA-OSTRGLAX3M-00	-	3		transparentna transparent прозрачная	



Profil GLAX przegrodowy dwustronny, do wypełnienia obrzeżem
 GLAX aluminium edge profile – double sided, option to fill with matching edge banding
 Профиль LED GLAX разделительный, кромочный, двухсторонний

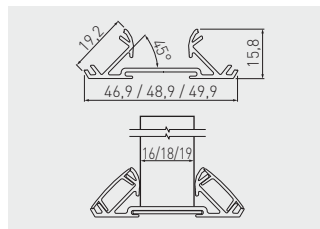

	 BOARD mm	 L mm			
PA-GLAXNBDW3M16-AL	16	3	profil profile профиль	srebrny silver серебристый	aluminium aluminium алюминий
PA-GLAXNBDW3M18-AL	18	3			
PA-GLAXNBDW3M19-AL	19	3			
PA-OSMLGLAX3M-00	-	3	ostonka cover крышка	mleczna frosted молочная	PC
PA-OSTRGLAX3M-00	-			transparentna transparent прозрачная	

Ostonki / Covers / Крышки



PA-OSMLGLAX3M-00



PA-OSTRGLAX3M-00

Profil GLAX cokołowy wąski, jednostronny
 Corner profile GLAX, one-sided, edge mounted
 Профиль GLAX торцевой, узкий, накладной, односторонний

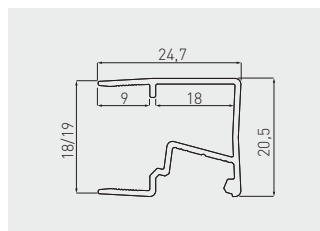

PA-GLAXMNBW3M-AL	18	3	profil profile профиль	srebrny silver серебристый	aluminium aluminium алюминий
PA-GLAXMNBW3M19-AL	19				
PA-OSMLGLAXM3M-00	-		ostonka mini cover mini крышка мини	mleczna frosted молочная	PC
PA-OSTRGLAXM3M-00	-			transparentna transparent прозрачная	

Ostonki / Covers / Крышки



PA-OSMLGLAXM3M-00



PA-OSTRGLAXM3M-00

Profil GLAX cokołowy wąski, dwustronny
 Corner profile GLAX, two-sided, edge mounted
 Профиль GLAX торцевой, узкий, накладной, двусторонний

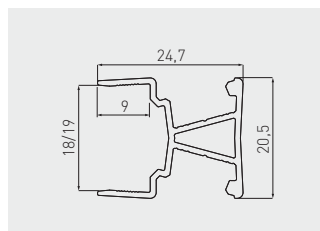

PA-GLAXMNBW3M-AL	18	3	profil profile профиль	srebrny silver серебристый	aluminium aluminium алюминий
PA-GLAXMNBW3M19-AL	19				
PA-0SMLGLAXM3M-00	-		ostonka mini cover mini крышка мини	mleczna frosted молочная	PC
PA-0STRGLAXM3M-00	-			transparentna transparent прозрачная	

Ostonki / Covers / Крышки



PA-0SMLGLAXM3M-00



PA-0STRGLAXM3M-00

Profil GLAX wpuszczany z poliwęglanu
 Recessed polycarbonate profile GLAX
 Профиль GLAX врезной из поликарбоната

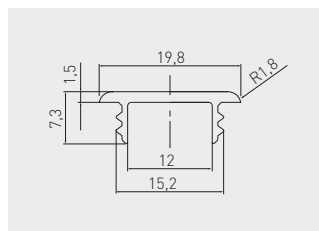

PW-PC61209-00

PW-PC31209-00N

PW-PC31209-00N	2	mleczna / frosted / молочная	PC
PW-PC61209-00		transparentna / transparent / прозрачная	

Oprawa VASCO nakładana / wpuszczana
 Fixture Vasco surface mounted / recessed
 Светильник Vasco накладной / врезной

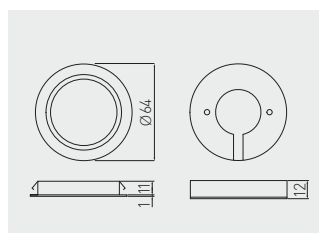

LD-VA24CB-53	130 mm	3000 K	aluminium aluminium алюминий	tworzywo plastic пластик
LD-VA24NE-53		4000 K		
LD-VA24ZB-53		6000 K		



Оправа LUMINO
 Fixture LUMINO
 Светильник LUMINO

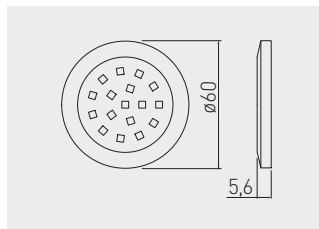

LD-LU16CB-53	70 – 85 lm	2700 K	aluminium aluminium алюминий	tworzywo plastic пластик
LD-LU16NE-53		4000 K		
LD-LU16ZB-53		6500 K		



Оправа Jovita
 Fixture Jovita
 Светильник Jovita

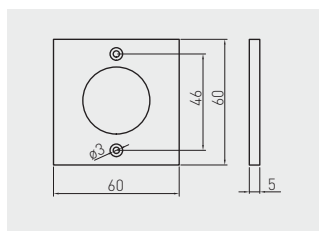

LD-KJVCOB-CB	200 lm	3000 K	aluminium aluminium алюминий	aluminium aluminium алюминий
LD-KJVCOB-ZB		6400 K		



Оправа Jovita
 Fixture Jovita
 Светильник Jovita

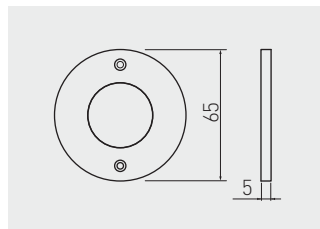

LD-0JVC0B-CB	200 lm	3000 K	aluminium aluminium алюминий	aluminium aluminium алюминий



Оправа Jovita
 Fixture Jovita
 Светильник Jovita

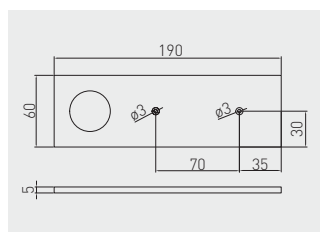

LD-PJVC0B-CB	200 lm	3000 K	aluminium aluminium алюминий	aluminium aluminium алюминий



Оправа CASTELLO z włącznikiem
 Fixture CASTELLO with switch
 Светильник CASTELLO с выключателем

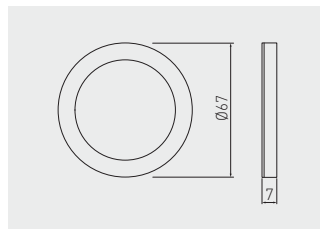

LD-CS36CB-53	180 lm	3200 K	aluminium aluminium алюминий	tworzywo plastic пластик
LD-CS36NE-53		4000 K		
LD-CS36ZB-53		6200 K		



Оправа VEGAS
 Fixture VEGAS
 Светильник VEGAS

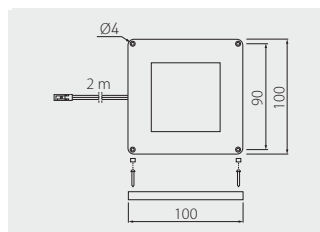

LD-VE15CB-53	140 lm	3000 K	aluminium aluminium алюминий	tworzywo / aluminium plastic / aluminium пластмасса / алюминий
LD-VE15NE-53	145 lm	4000 K		
LD-VE15ZB-53	150 lm	6400 K		



Оправа VEGAS 2 w 1
 Fixture VEGAS 2 in 1
 Светильник VEGAS 2 в 1

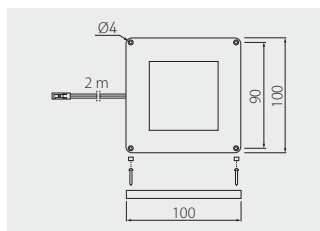

Powiązane produkty:
 Włącznik, regulator światła
 AE-WLKON-20
 Related products:
 Switch, colour temperature controller
 AE-WLKON-20



Связанных с ними продуктов:
 Выключатель, регулятор цветовой температуры
 AE-WLKON-20

LD-VE15CBZB-53	140 lm	3000 K - 6400 K	aluminium aluminium алюминий	tworzywo, aluminium plastic, aluminium пластмасса, алюминий



Оправа ALVARO wpuszczana
 Recessed fixture ALVARO
 Врезной светильник ALVARO

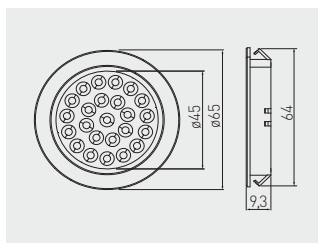

LD-AL24CB-53	130 lm	3000 K	aluminium aluminium алюминий	tworzywo plastic пластик
LD-AL24NE-53		4000 K		
LD-AL24ZB-53		6400 K		



Оправа TREVI
 Fixture TREVI
 Светильник TREVI

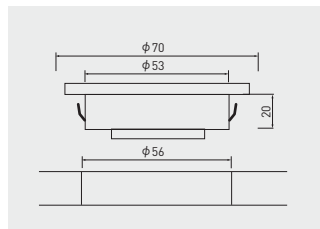

LD-TR24CB-53	300 lm	3000 K	aluminium aluminium алюминий	tworzywo plastic пластик
LD-TR24NE-53	220 lm	4000 K		
LD-TR24ZB-53	300 lm	6400 K		



Оправа трójkатна з втáчннкнм
 Triangle fixture with switch
 Треугольный светильник с выключателем

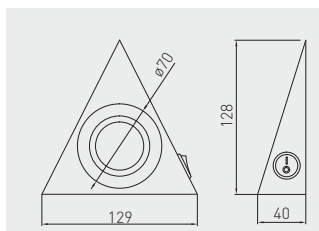

LD-OPT30S-53N	100 lm	3000 K	aluminium / aluminium / алюминий	stal steel сталь
LD-OPT60S-53N		6400 K		
LD-OPT60S-51N		6400 K		



Zestaw opraw CASTELLO z włącznikiem
 Fixture kit with switch CASTELLO
 Комплект светильников CASTELLO с выключателем

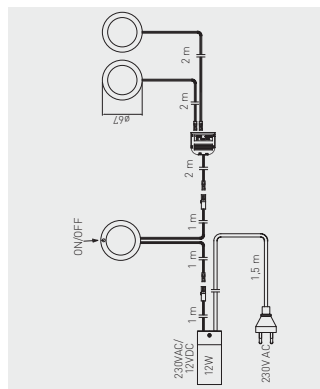

LD-Z3CSCB-53

3 x 180 lm

● 3000 K

aluminium / aluminium / алюминий

tworzywo / plastic / пластик



Zestaw opraw CASTELLO z włącznikiem
 Fixture kit CASTELLO with switch
 Комплект светильников CASTELLO с выключателем

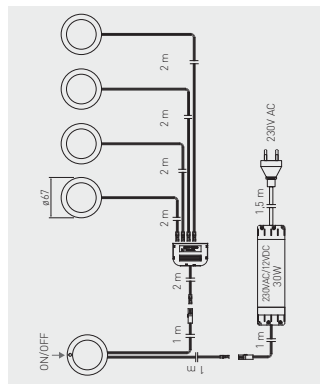

LD-Z5CSCB-53

5 x 180 lm

● 3000 K

aluminium / aluminium / алюминий

tworzywo / plastic / пластик



Zestaw opraw LUGO
 Fixture kit LUGO
 Комплект светильников LUGO

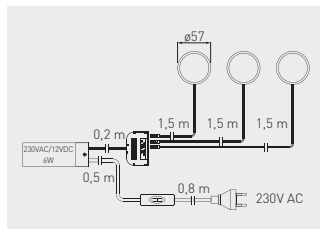

LD-LCG319-53	3 x 110 lm		3000 K	aluminium / aluminium / алюминий	tworzywo plastic / пластик	10	
LD-LUG319-53						6400 K	20
LD-LCG319-40			3000 K	chrom / chrome / хром		16	
LD-LUG319-40						6400 K	20
LD-LCG319-52				3000 K		satyna / satin / сатин	20
LD-LUG319-52				6400 K			20



Zestaw opraw BARRI
 Fixture kit BARRI
 Комплект светильников BARRI

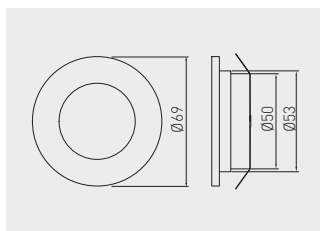

LD-OBP27CB-53	3 x 80 lm		2700 K	aluminium / aluminium / алюминий	aluminium, tworzywo aluminium, plastic / алюминий, пластмасса
LD-OBP27ZB-53					



Zestaw opraw MARBELLA
 Fixture kit MARBELLA
 Комплект светильников MARBELLA

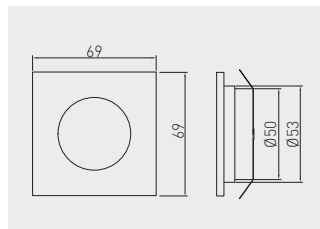

LD-KWP27CB-53	3 x 80 lm	2700 K	aluminium aluminium	aluminium, tworzywo aluminium, plastic
LD-KWP27ZB-53		6400 K	aluminium алюминий	



Oprawa OVIEDO wpuszczana
 Recessed fixture OVIEDO
 Врезной светильник OVIEDO

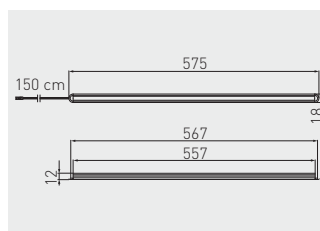





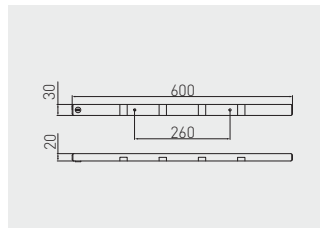

LD-WL2457-53	90 lm	6400 K	aluminium aluminium алюминий	aluminium, tworzywo aluminium, plastic алюминий, пластмасса



Оправа FRAGA podszafkowa z włącznikiem
 Cabinet fixture with switch FRAGA
 Светильник под шкафчики FRAGA с выключателем







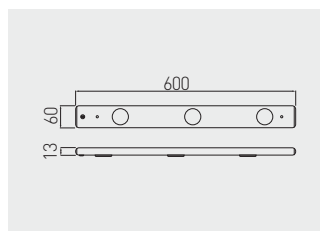

					
LD-OP408C-53	3 W	90 lm	6400 K	aluminium aluminium алюминий	aluminium, tworzywo aluminium, plastic алюминий, пластмасса



Оправа ROTA podszafkowa
 Cabinet ROTA fixture
 Светильник ROTA под шкафчики



					
LD-OP456C-53	4,2 W	230 lm	6400 K	aluminium aluminium алюминий	aluminium, tworzywo aluminium, plastic алюминий, пластмасса
LD-OP609C-53	5,5 W	310 lm			



Oprowa OPD podszafkowa
Under cabinet LED lamp fixture OPD
Светодиодный светильник OPD под шкафчик

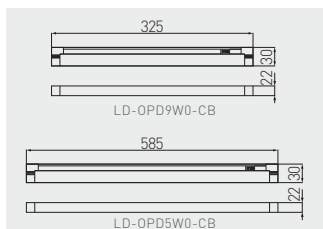

LD-OPD5W0-CB	5 W	300 lm	● 3000 K	chrom	metal
LD-OPD9W0-CB	9 W	350 lm		chrom хром	metal металл



Oprowa SORIA z czujnikiem zbliżeniowym
Fixture with proximity sensor SORIA
Светильник с датчиком приближения SORIA

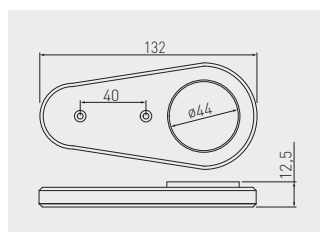

LD-SR16CB-53	90 - 110 lm	● 3000 K	aluminium aluminium алюминий	aluminium aluminium алюминий
LD-SR16NE-53		● 4000 K		
LD-SR16ZB-53		● 6400 K		



Оправа RADIUS II на wysięgniku
 Fixture with arm RADIUS II
 Светильник типа „дуга” RADIUS II

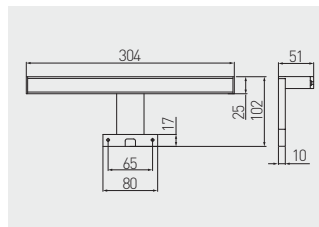

LD-RA60CB-40N	220 lm	3000 K	chrom chrome хром	tworzywo plastic пластмасса
LD-RA60ZB-40N		6400 K		



Оправа MAXIMUS на wysięgniku
 Fixture with arm MAXIMUS
 Светильник типа „дуга” MAXIMUS

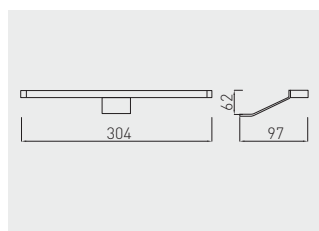

LD-MAX60CB-40N	160 lm	3000 K	chrom chrome хром	aluminium, tworzywo aluminium, plastic алюминий, пластмасса
LD-MAX60ZB-40N		6400 K		



Oprawa ABELLA na wysięgniku
 Fixture with arm ABELLA
 Светильник типа „дуга” ABELLA

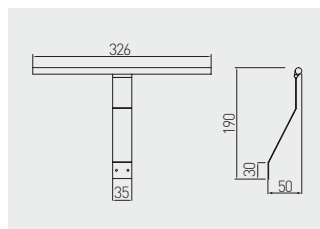

LD-AB18CB-53	460 lm	3000 K	aluminium aluminium алюминий	stal, aluminium, tworzywo steel, aluminium, plastic сталь, алюминий, пластмасса
LD-AB18ZB-53		6400 K		



Oprawa EVITA na wysięgniku
 Fixture with arm EVITA
 Светильник типа „дуга” EVITA

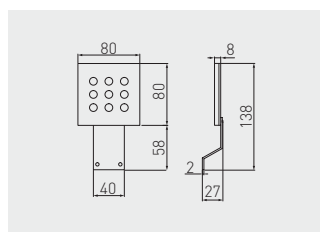

LD-EIW09CB-CZ	120 lm	3000 K	czarny / black / чёрный	aluminium, tworzywo aluminium, plastic алюминий, пластмасса



Оправа NOELIA на wysięgniku
 Fixture with arm NOELIA
 Светильник типа „дуга” NOELIA

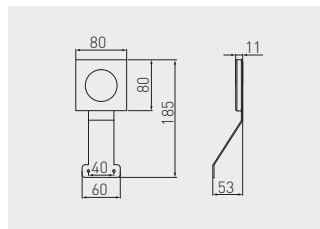

LD-N024CB-00	330 lm	3000 K	aluminium aluminium алюминий	aluminium, tworzywo aluminium, plastic алюминий, пластмасса
LD-N024ZB-00		6400 K		



Оправа FIDELIA на wysięgniku
 Fixture with arm FIDELIA
 Светильник типа „дуга” FIDELIA

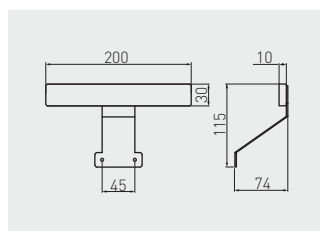

LD-FL36CB-00	155 lm	3000 K	aluminium aluminium алюминий	aluminium, tworzywo aluminium, plastic алюминий, пластмасса
LD-FL36ZB-00	165 lm	6400 K		



Оправа CALDERON на wysięgniku
 Fixture with arm CALDERON
 Светильник типа „дуга” CALDERON

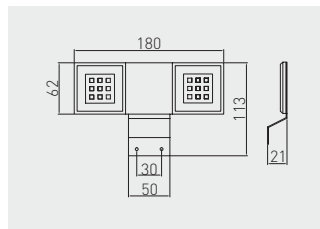

LD-NKW18CB-40	270 lm	3000 K	chrom	stal, tworzywo steel, plastic
LD-NKW18ZB-40		6400 K	chrome хром	



Оправа COMA bezprzewodowa
 Wireless fixture COMA
 Беспроводной светильник COMA



LD-IRUSB-53

LD-PIRUSB-53

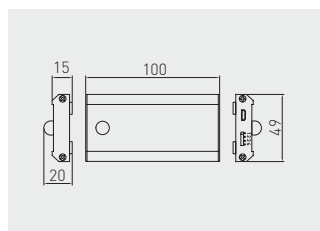

Dodatkowy przewód USB (do ładowania) – 0,5 m w komplecie
 Additional 0,5m USB cable (for charging)

Дополнительный кабель USB (для зарядки) – 0,5 м

LD-IRUSB-53	40 – 50 lm	4000 K	Czujnik zbliżeniowy IR, jedno- lub dwubiegunowy Proximity sensor IR, single or double-pole Датчик движения IR, одно- и многофункциональный	aluminium aluminium алюминий	metal, tworzywo metal, plastic металл, пластик
LD-PIRUSB-53			Czujnik ruchu PIR, jednobiegunowy Proximity sensor IR, single-pole Датчик движения PIR, однофункциональный		



Lampka CHICAGO z portem USB
 Bed lamp with USB CHICAGO
 Гибкая лампа с USB-разъемом CHICAGO

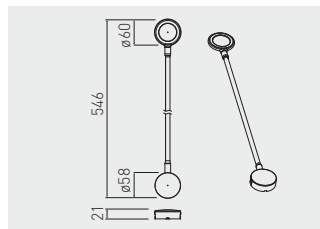

Wymaga zasilacza 12 V, 24 W
 Requires 12 V, 24 W power supply
 Требуется блок питания 12 В, 24 Вт

LD-CHIC16NE-10	120 lm	● 4000 K	biały / white / белый	
LD-CHIC16NE-20			czarny / black / чёрный	
			stal, tworzywo steel, plastic сталь, пластмасса	



Lampka BOSTON
 Lamp BOSTON
 Лампа BOSTON

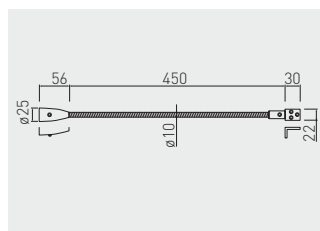

LD-BOS1CBWB-53

LD-BOS1CBWG-53

Wymaga zasilacza 12 V, 6 W
 Requires 12 V, 6 W power supply
 Требуется блок питания 12 В, 6 Вт

LD-BOS1CBWB-53	90 lm	● 3000 K	aluminium aluminium алюминий	
LD-BOS1CBWB-53			stal, aluminium, tworzywo steel, aluminium, plastic сталь, алюминий, пластмасса	



Klip plastikowy LED do półek
 Plastic LED clip for shelves
 Пластиковая клипса LED для стеклянных полок

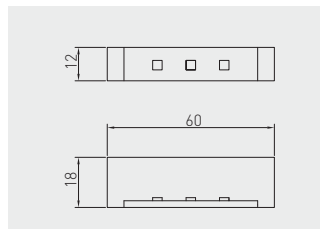

			
LD-KLPCB-00N	10 lm	● 3200 K	tworzywo plastic пластик
LD-KLPNB-00N	-	niebieski / blue / синий	
LD-KLPZB-00N	12 lm	● 6200 K	



Klip metalowy LED do półek
 Metal LED clip for shelves
 Металлическая клипса LED для стеклянных полок

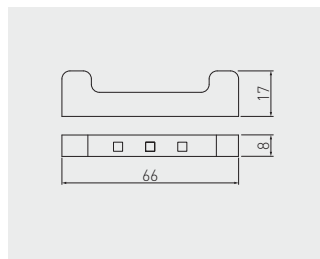



			
LD-3SKL-CBN	10 lm	● 3200 K	stal steel сталь
LD-3SKL-NBN	-	niebieski / blue / синий	
LD-3SKL-ZBN	12 lm	● 6200 K	

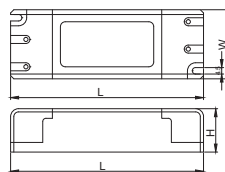

Zasilacz LED PRO
LED PRO power feeder units
Блоки питания LED PRO

NEW





		 L-W-H mm	
LD-ZASPR007W-30	7 W	100 x 39 x 25 mm	tworzywo plastic пластик
LD-ZASPR012W-30	12 W	120 x 42 x 27 mm	
LD-ZASPR016W-30	16 W	120 x 42 x 27 mm	
LD-ZASPR024W-30	24 W	140 x 47 x 29 mm	
LD-ZASPR033W-30	33 W	140 x 47 x 29 mm	
LD-ZASPR054W-30	54 W	155 x 53 x 30 mm	
LD-ZASPR065W-30	65 W	181 x 63 x 40 mm	
LD-ZASPR080W-30	80 W	181 x 63 x 40 mm	

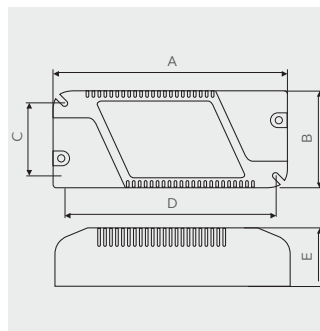

Zasilacz LED
LED power supply
Светодиодный трансформатор LED







		$A \times B \times C \times D \times E$  mm	
LD-ZAS75W-30	max 75 W	180 x 52 x 42 x 176 x 30	tworzywo, plastic пластик

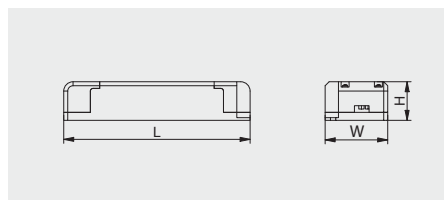

Zasilacz LED
LED power supply
Светодиодный трансформатор LED

NEW



		$L \times W \times H$  mm	
LD-ZAS24PR080W-30	max. 80 W	181 x 63 x 40 mm	tworzywo, plastic, пластик, пластик



Układ zasilający
Power feeder set
Блок питания

NEW

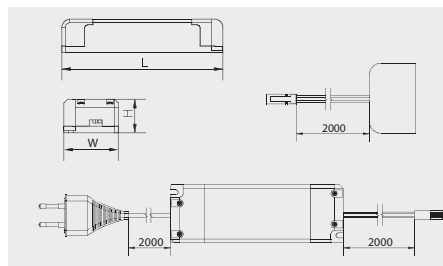

LD-ZZAS07PROKD6	7 W	100 x 39 x 25	tworzywo plastic пластик
LD-ZZAS12PROKD6	12 W	120 x 42 x 27	
LD-ZZAS16PROKD6	16 W	120 x 42 x 27	
LD-ZZAS24PROKD6	24 W	140 x 47 x 29	
LD-ZZAS33PROKD6	33 W	155 x 53 x 30	



Zasilacz LED SLIM HQ
LED power feeder SLIM HQ
Светодиодный блок питания LED SLIM HQ

NEW

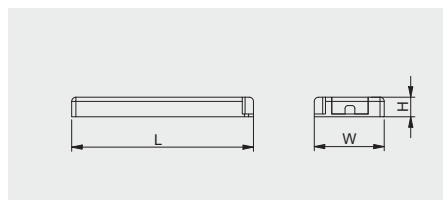

LD-SZAHQ06W-MA**	6 W	98 x 46 x 11 mm	tworzywo plastic пластик
LD-SZAHQ15W-MA*	15 W	128 x 50 x 14 mm	
LD-SZAHQ30W-MA*	30 W	156 x 50 x 17 mm	
LD-SZAHQ50W-MA	50 W	160 x 58 x 18 mm	
LD-SZAHQ75W-MA	75 W	160 x 58 x 18 mm	



Zasilacz LED

Power supply

Блок питания для светодиодных светильников

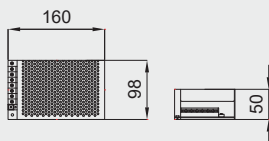

		
LD-ZAS150-NW	max. 150 W	aluminium aluminium алюминий



Zasilacz LED

Power supply

Блок питания для светодиодных светильников

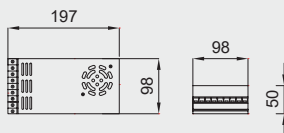

		
LD-ZAS350-NW	max. 350 W	aluminium aluminium алюминий



Zasilacz LED
Power supply
Блок питания для
светодиодных светильников



LD-WZA20W-NW	20 W	tworzywo plastic / пластик
LD-WZA36W-NW	36 W	
LD-WZA60W-NW	60 W	
LD-WZA80W-NW	80 W	
LD-WZA150W-NW	150 W	

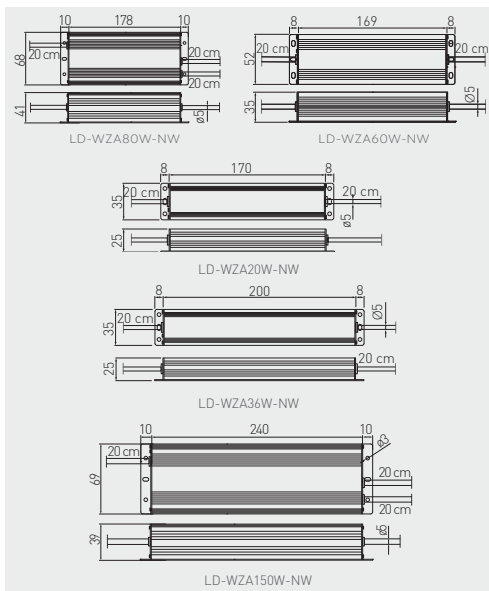

Zasilacz LED puszkowy
LED power supply
Светодиодный трансформаторLED



LD-ZASPU15W-30N	15 W	tworzywo / plastic / пластик
-----------------	------	------------------------------

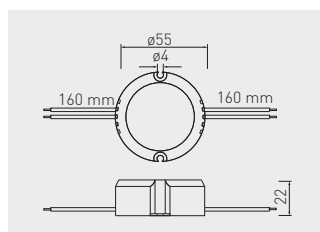

Układ zasilający do klipów LED 5-punktowy
 Power supply set for 5 LED clips
 Блок питания для светодиодных клипс, 5 разъемов

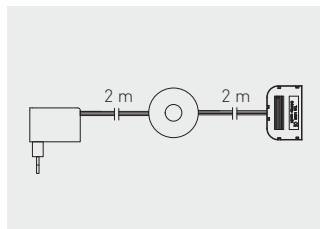

LD-ZSKL15-00

tworzywo / plastic / пластик



Układ zasilający
 Power supply set
 Блок питания

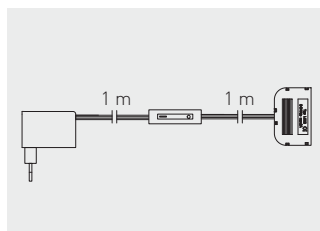

LD-ZWND6W-10

max. 6 W

tworzywo

LD-ZWND12-10

max. 12 W

plastic
 пластик



Transformator elektroniczny do żarówek halogenowych
 Electronic power supply for halogen lamp
 Электронный трансформатор для галогенной лампы

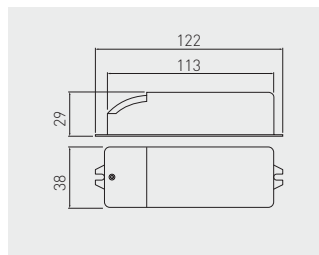

TE-600000-30	max. 60 W	tworzywo plastic пластик



Kontroler RGB mini z pilotem
 Mini RGB controller with remote
 Миниконтроллер RGB с пультом

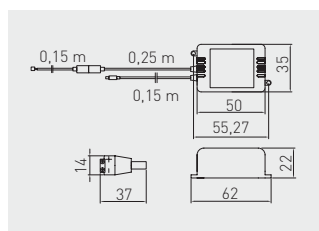

LD-KONMINI-RGB	RGB	tworzywo / plastic / пластик



Zestaw RGB – kontroler, zasilacz LED 6W, pilot i dystrybutor
 RGB kit – RGB controller, power supply, remote and distributor
 Комплект RGB – контролер, трансформатор 6W, пульт, дистрибьютор

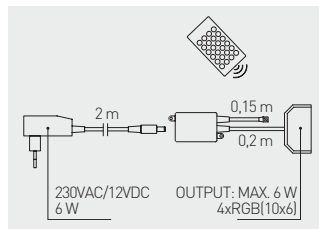

LD-ZAC6WDE-RGB	RGB	tworzywo / plastic / пластик



Zestaw RGB, taśma LED 5 m, kontroler, zasilacz, pilot
 RGB-set, LED band 5 m, RGB controller, LED-transformator, pilot
 Комплект RGB, лента LED 5 м, контролер, трансформатор, пульт

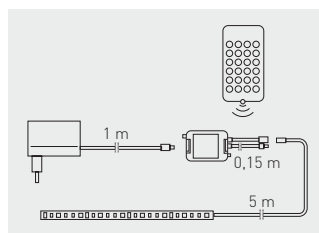





LD-ZL5RGB150-00	RGB	tworzywo / plastic / пластик



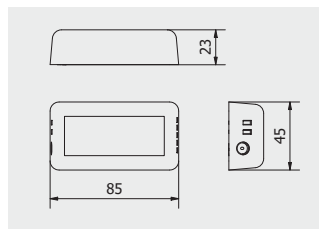

Kontroler 1-strefowy RGBW
 1-zone controller RGBW
 1-х зонный контроллер RGBW





		
LD-KONML-RGBW	RGB	tworzywo / plastic / пластик

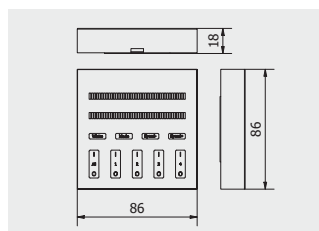

Panel dotykowy 4-strefowy na baterie RGBW
 Battery powered 4-zone touch panel RGBW
 4-зонная сенсорная панель с батарейками RGBW



		
LD-KONML-WRGB-PAN	RGB	tworzywo / plastic / пластик



Pilot 4-strefowy RGBW
 4-zone remote controller RGBW
 4-зонный пульт дистанционного управления RGBW

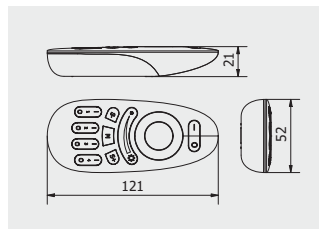

LD-KONML-RGBW-PIL

RGB

tworzywo / plastic / пластик



Kontroler WiFi
 WiFi-controller
 WiFi – контроллер

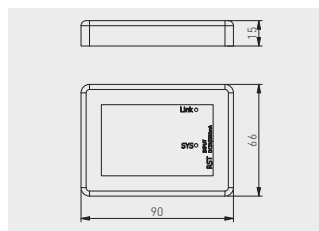

LD-KONML-WIFI

RGB

tworzywo / plastic / пластик



Kontroler 1-strefowy MONO
 1-zone controller MONO
 1-х зонный контроллер MONO

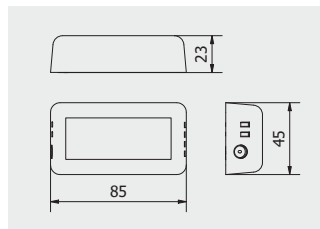

LD-KONML-MONO	RGB	tworzywo / plastic / пластик

--	--	--	--	--	--	--	--

Panel dotykowy 4-strefowy na baterie MONO
 Battery powered 4-zone touch panel MONO
 4-зонная сенсорная панель с батарейками MONO

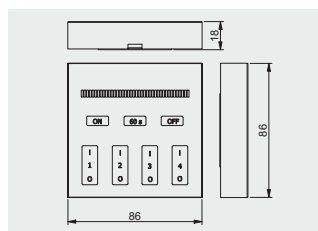

LD-KONML-MONO-PAN	tworzywo / plastic / пластик

--	--	--	--	--

Pilot 4-strefowy MONO
4-zone remote controller MONO
4-зонный пульт дистанционного управления MONO

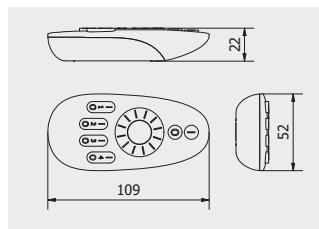

LD-KONML-MONO-PIL

tworzywo / plastic / пластик



Adapter do pilota
Remote control adapter
Адаптер пульта дистанционного управления

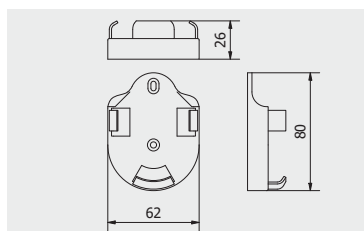

LD-KONML-AD

biały / white / белый

tworzywo / plastic / пластик



Włącznik dotykowy bezprzewodowy on-off
Wireless touchless switch on-off
Беспроводной сенсорный выключатель on-off

NEW

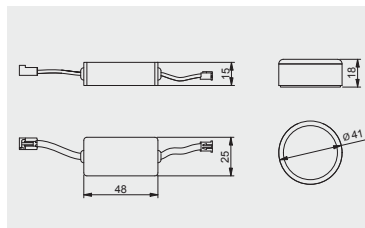

AE-WDBP1-10	biały / white / белый	tworzywo plastic пластик
AE-WDBP1-20	czarny / black / чёрный	



Włącznik dotykowy bezprzewodowy CCT
Wireless touchless switch CCT
Беспроводной сенсорный выключатель CCT

NEW

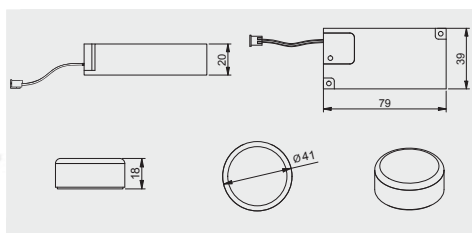



AE-WDBP2CCT-10	biały / white / белый	tworzywo plastic пластик
AE-WDBP2CCT-20	czarny / black / чёрный	

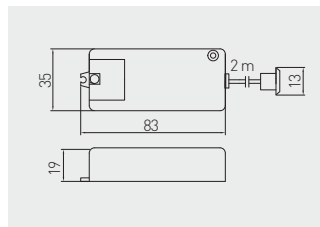

Włącznik bezdotykowy
Touchless switch
Бесконтактный датчик



		
AE-WBEZDC-10S	dwubiegowy two-pole двухфункциональный	tworzywo plastic пластик
AE-WBEZDB-10S	jednobiegowy single-pole однофункциональный	



Włącznik dotykowy pod śrubę
Touch switch under screw
Сенсорный выключатель под винт

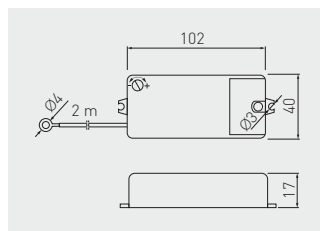

	
AE-WBEZDK15-10	tworzywo plastic пластмасса



Włącznik z czujnikiem ruchu PIR
 Switch with PIR motion detector
 Выключатель с датчиком движения PIR

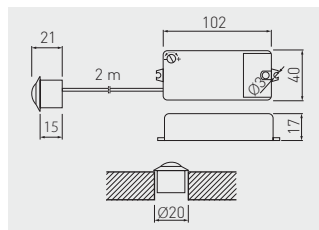

AE-WBEZDPIR-10

tworzywo
 plastic
 пластмасса



Włącznik z dwoma sensorami ruchu PIR II
 Switch with two PIR II motion sensors
 Выключатель с двумя датчиками движения PIR II

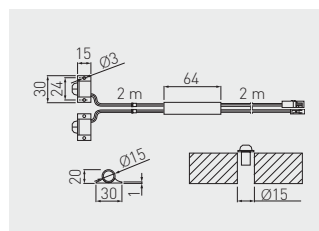

AE-WBEZDPIR2-20

tworzywo
 plastic
 пластмасса



Włącznik bezdotykowy uniwersalny 3 w 1
 3 in 1 all-purpose touchless switch
 Бесконтактный выключатель 3 в 1

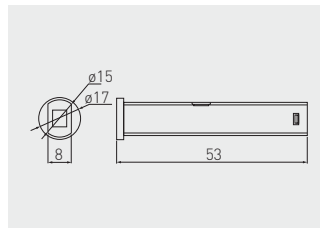

AE-WBBUNI-10DIM	biały / white / белый	tworzywo plastic / пластик
AE-WBCUNI-10DIM	czarny / black / чёрный	



Włącznik dotykowy ściemniający
 Dimmable touch switch
 Выключатель с регулятором яркости

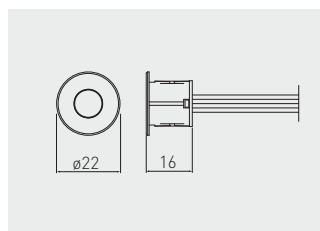

AE-WDSB-10DIM	biały / white / белый	tworzywo plastic / пластик
AE-WDSC-10DIM	czarny / black / чёрный	



Włącznik dotykowy ściemniający
Dimmable touch switch
Выключатель с регулятором яркости

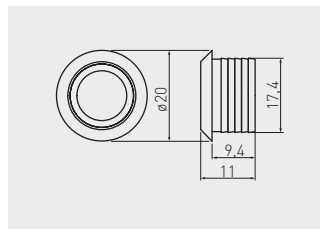

AE-WBEZD-NB	chrom chrome хром	tworzywo plastic пластик



Włącznik podblatowy
Countertop switch
Выключатель под столешницу

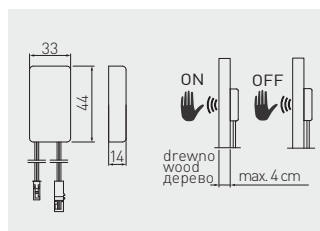

Grubość blatu max. 40 mm
Countertop thickness max. 40 mm
Толщина столешницы макс. 40 мм

AE-WPDRW-00	tworzywo / plastic / пластик



Włącznik do taśm LED montowany w profil
 Switch for LED strips mounted in profile
 Выключатель для ленты LED

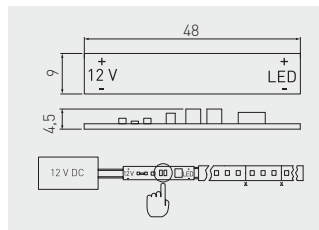

AE-WLPR-60	-	biały white белый	plytka elektroniczna circuit board электронная плата	1000
AE-WLPR-60P2	2 m			500



Ściemniacz LED
 LED dimmer
 Светодилдный диммер

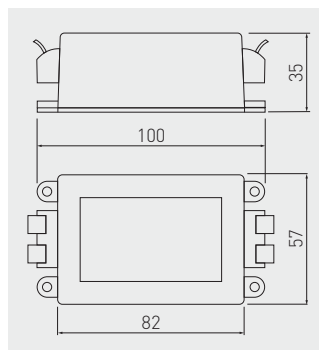

LD-DIMLED-10	czarny / black / чёрный	PC



Włącznik, regulator światła
Switch, colour temperature controller
Выключатель, регулятор цветовой температуры

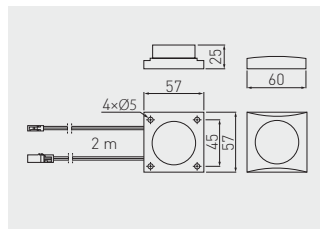

AE-WLKON-20	czarny black чёрный	tworzywo plastic пластмасса



Włącznik kotykowski
Switch
Выключатель кнопочный

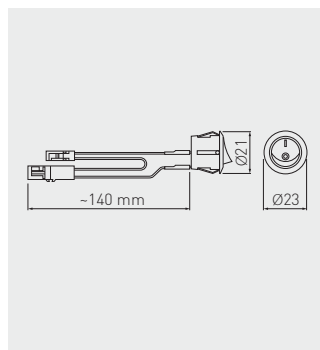

AE-WLB01-10	biały / white / белый	tworzywo plastic пластик
AE-WLC01-20	czarny / black / чёрный	



Włącznik łańcuszkowy

Pull chain switch

Выключатель для бра и торшеров с цепочкой

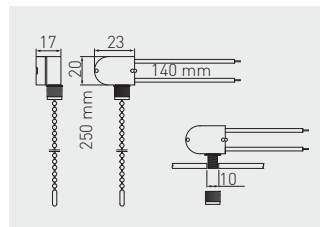

AE-WLLAN1-10

chrom / chrome / хром

tworzywo / plastic / пластик



Kabel zasilający z wtyczką i włącznikiem

Cable with plug & switch

Кабель с вилкой и выключателем

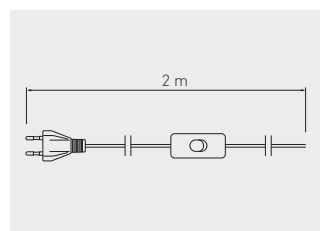

LD-KABE2M-00

biały / white / белый

tworzywo / plastic / пластик



Przewód ze złączkami mini AMP
 Cable with Mini AMP
 Кабель с соединителями мини-AMP

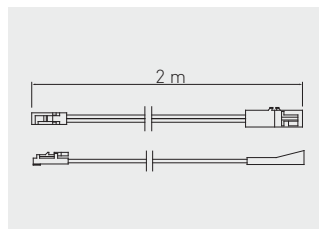

		
LZ-KAPR2M-10	czarny / black / чёрный	tworzywo / plastic / пластик



Złączka do oświetlenia ledowego z dystrybutorem, 3 gniazda
 LED lamp connector with distributor, 3 sockets
 Соединитель LED с распределителем, 3 гнезда

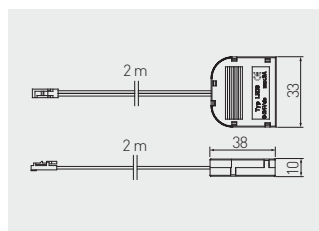

		
LZ-AKZ312-10N	czarny / black / чёрный	tworzywo / plastic / пластик



Złączka do oświetlenia ledowego z dystrybutorem, 6 gniazd
 LED lamp connector with distributor, 6 sockets
 Соединитель LED с распределителем, 6 гнезд

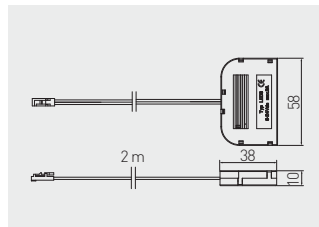

LZ-AKZ612-10N	czarny / black / чёрный	tworzywo / plastic / пластик



Złączka XC11 do taśm LED
 Connector XC11 for LED strips
 Соединитель XC11 для лент LED



LD-ZTL8MM-02N



LD-ZTL8MM-02N600



LD-ZTL10MM-02N



LD-ZTLRGB-04N

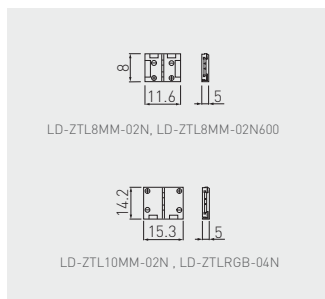

LD-ZTL8MM-02N	8 mm	tworzywo plastic пластик
LD-ZTL8MM-02N600	8 mm, 600 LED	
LD-ZTL10MM-02N	10 mm	
LD-ZTLRGB-04N	RGB	



Złączka XC11 do taśm LED kątowa
 Angular connector XC11 for LED strips
 Угловой соединитель XC11 для лент LED



LD-ZTKT8MM-02N

LD-ZTKT8MM-02N600



LD-ZTKT10MM-02N

LD-ZTKTRGB-02N

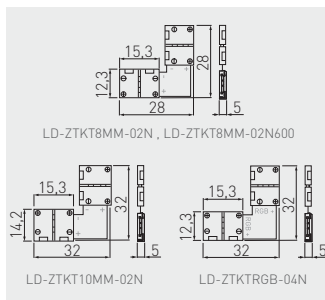

LD-ZTKT8MM-02N	8 mm	tworzywo plastic пластик
LD-ZTKT8MM-02N600	8 mm / 600 LED	
LD-ZTKT10MM-02N	10 mm	
LD-ZTKTRGB-04N	RGB	



Złączka XC11 do taśm LED z przewodem 15 cm
 Connector XC11 with 15 cm cord, for strips
 Соединитель XC11 для лент LED, с проводом 15 см



LD-ZTK8MM-02N

LD-ZTK8MM-02N600

LD-ZTK10MM-02N

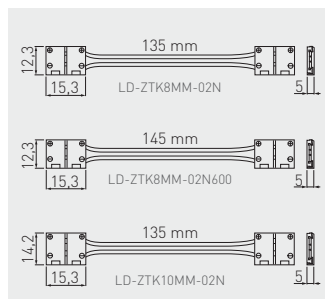

LD-ZTK8MM-02N	8 mm	tworzywo plastic пластик
LD-ZTK8MM-02N600	8 mm / 600 LED	
LD-ZTK10MM-02N	10 mm	



Złącza XC11 do taśm LED z przewodem 2 m
 Connector XC11 with 2 m cord, for LED strips
 Соединитель XC11 для лент LED, с проводом 2 м

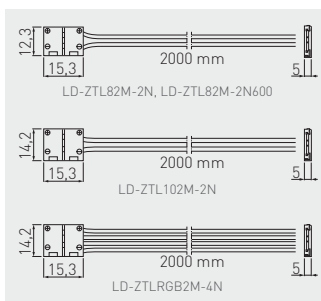

LD-ZTL82M-2N	8 mm	tworzywo plastic пластик	
LD-ZTL82M-2N600	8 mm / 600 LED		
LD-ZTL102M-2N	10 mm		
LD-ZTLRGB2M-4N	RGB		



Złącza XC11 do taśm LED z przewodem 2 m i mini amp
 Connector XC11 with 2 m cord and mini AMP, for LED strips
 Соединитель XC11 для лент LED, с проводом 2 м и мини amp

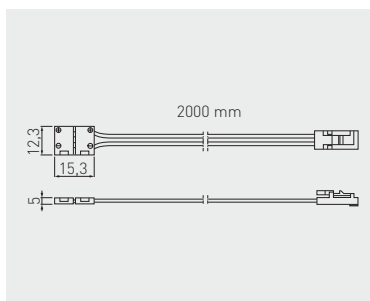

LD-ZTL8MMAMP-02N	8 mm	tworzywo plastic пластик	
LD-ZTL8MMAMP-02N600	8 mm / 600 LED		



Złączka XC11 do taśm LED SLIM
 Connector XC11 for LED strips SLIM
 Соединитель XC11 для лент LED SLIM



LD-ZTLS8MM-02N LD-ZTKS8MM-02N LD-ZTLS82M-2N LD-ZTLS8MMAMP-02N

LD-ZTLS8MM-02N	8 mm	tworzywo plastic пластик
LD-ZTKS8MM-02N		
LD-ZTLS82M-2N		
LD-ZTLS8MMAMP-02N		

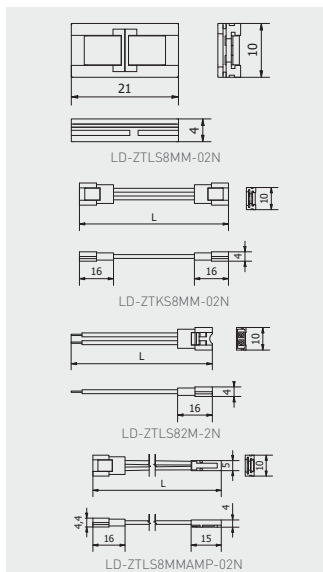

Ładowarka indukcyjna z zasilaczem
 Wireless charger with power supply
 Беспроводное зарядное устройство с блоком питания

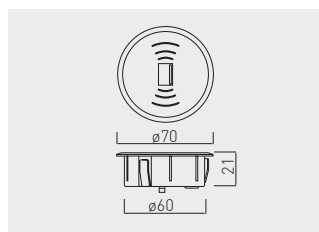

AE-ZUSB-20	czarny / black / чёрный	tworzywo plastic пластмасса



Ładowarka bezprzewodowa, indukcyjna, podblatowa z zasilaczem
 Wireless surface charger, under the countertop mount
 Беспроводное зарядное устройство, под столешницу

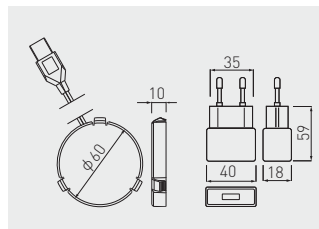

AE-ZLADPOD-20	czarny / black / чёрный	tworzywo plastic пластик



Ładowarka bezprzewodowa LUX z zasilaczem
 Inductive charger with a power feeder LUX
 Зарядное устройство индукционное с блоком питания LUX

NEW

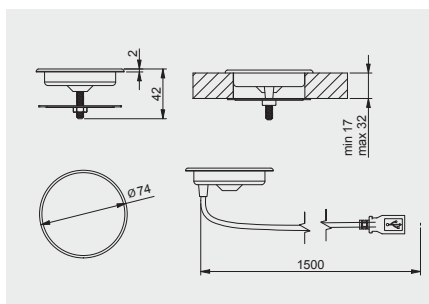

AE-ZLADLUX-40	chrom / chrome / хром	tworzywo plastic пластик



Przedłużacz biurkowy wpuszczany CHARGER
 Desk recessed power socket CHARGER
 Настольный удлинитель, встраиваемый CHARGER



AE-BPW1S2UCH-80

AE-BPW1U2UCH-80

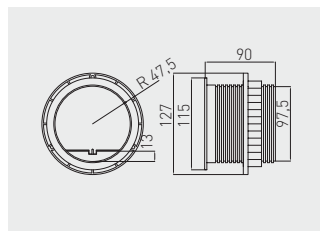

AE-BPW1S2UCH-80	100	schuko	srebrny silver	tworzywo plastic пластмасса
AE-BPW1U2UCH-80		french	серебристый	



Przedłużacz biurkowy wpuszczany SLIDE
 Desk recessed power socket SLIDE
 Настольный удлинитель, встраиваемый SLIDE



AE-BPW1U1UCH-51

AE-BPW1S1UCH-51

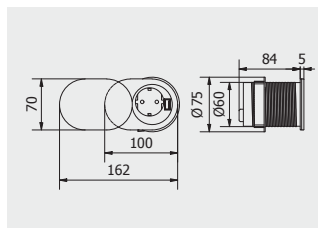

AE-BPW1U1UCH-51	french	USB 5V / 2,4A	aluminium aluminium алюминий	tworzywo plastic пластмасса
AE-BPW1S1UCH-51	schuko			





Przedłużacz biurkowy wpuszczany CHARGER MINI
 Desk recessed power socket CHARGER MINI
 Настольный удлинитель, встраиваемый CHARGER MINI



AE-BPW1S1UCH-53

AE-BPW1U1UCH-53

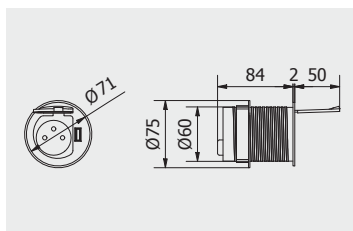

AE-BPW1U1UCH-53	60	french	aluminium aluminium алюминий	tworzywo plastic пластмасса
AE-BPW1S1UCH-53		schuko		



Przedłużacz biurkowy wpuszczany COMFORT
 Desk recessed power socket COMFORT
 Настольный удлинитель, встраиваемый COMFORT



AE-BPW3S100U-53

AE-BPW4U100-53

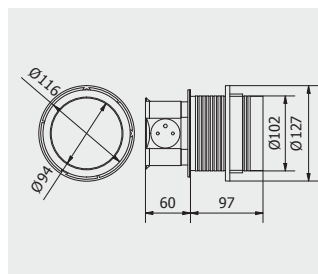

AE-BPW4U100-53	100	french	-	aluminium aluminium алюминий	aluminium, tworzywo aluminium, plastic алюминий, пластмасса
AE-BPW4S100-53		schuko			
AE-BPW3U100U-53		french	5V USB max. 2A		
AE-BPW3S100U-53		schuko			





Przedłużacz biurkowy wpuszczany okrągły \varnothing 100
 Pull-out power socket – round \varnothing 100
 Выдвижной настольный удлинитель, круглый \varnothing 100



AE-BPW3GU-80



AE-BPW3GU-20

	 mm			
AE-BPW3GU-20	100	french	czarny / black / чёрный	aluminium, tworzywo aluminium, plastic алюминий, пластмасса
AE-BPW3GU-80			srebrny / silver / серебристый	
AE-BPW3GS-20	schuko	schuko	czarny / black / чёрный	
AE-BPW3GS-80			srebrny / silver / серебристый	

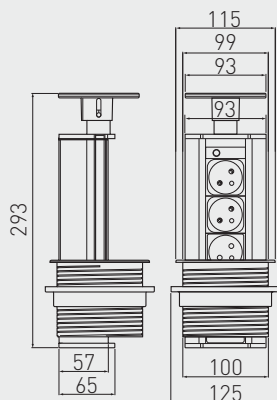



Przedłużacz biurkowy wpuszczany okrągły \varnothing 60
 Pull-out power socket – round \varnothing 60
 Выдвижной настольный удлинитель, круглый \varnothing 60



AE-BPW3U60-20



AE-BPW3U60-80



AE-BPW3U60U-20



AE-BPW3U60U-80

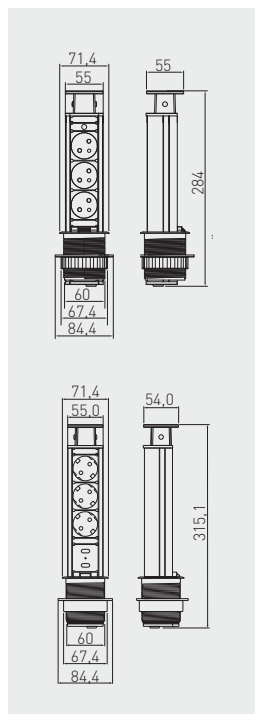

AE-BPW3U60-20	60	french	-	czarny / black / чёрный	aluminium, tworzywo aluminium, plastic алюминий, пластмасса	
AE-BPW3U60-80				srebrny / silver / серебристый		
AE-BPW3S60-20		schuko		czarny / black / чёрный		
AE-BPW3S60-80				srebrny / silver / серебристый		
AE-BPW3U60U-20		5V USB max. 2A		french		czarny / black / чёрный
AE-BPW3U60U-80						srebrny / silver / серебристый
AE-BPW3S60U-20				schuko		czarny / black / чёрный
AE-BPW3S60U-80						srebrny / silver / серебристый



Przedłużacz biurkowy wpuszczany prostokątny
 Rectangular pop-up power and connection socket
 Настольный удлинитель, прямоугольный, врезной



AE-PB03GS-53	schuko	-	aluminium aluminium алюминий	stal, tworzywo steel, plastic сталь, пластмасса	
AE-PB03GU-53	french	-			
AE-PBC3GU-53	french	1,5 m	czarny / black / чёрный		
AE-PBC3GU-20	french	1,5 m			
AE-PBC3GU-10	french	1,5 m	biały / white / белый		



Przedłużacz biurkowy wpuszczany prostokątny
 Rectangular pop-up power and connection socket
 Настольный удлинитель, прямоугольный, врезной



AE-PBU2GU-10	french	biały / white / белый		stal, tworzywo steel, plastic сталь, пластмасса	
AE-PBU2GU-20		czarny / black / чёрный			
AE-PBU2GU-53		aluminium / aluminium / алюминий			



Przedłużacz biurkowy wpuszczany prostokątny
 Rectangular pop-up power and connection socket
 Настольный удлинитель, прямоугольный, врезной

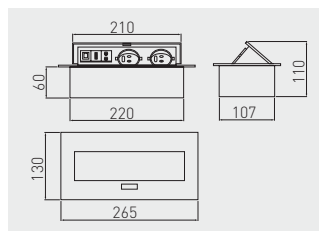

AE-PB02GS-53	schuko	-	-	aluminium aluminium алюминий	stal, tworzywo steel, plastic сталь, пластмасса
AE-PB02GU-53	french	-			
AE-PBC2GU-53	french	1,5 m			



Przedłużacz biurkowy wpuszczany z HDMI
 Desk recessed power socket with HDMI port
 Настольный удлинитель, встраиваемый с выходом HDMI



AE-PB02GSHDMI-53	schuko	1 x HDMI, 1 x USB, 1 x RJ45	-	-	aluminium aluminium алюминий	aluminium, stal aluminium, steel алюминий, сталь
AE-PBC2GUHDMI-53	french	1 x HDMI	1,5 m			
AE-PBC2GSHDMI-53	schuko					



Przedłużacz biurkowy wpuszczany SOFT
 Desk recessed power socket SOFT
 Настольный удлинитель, встраиваемый SOFT



AE-PBSC3GS-20



AE-PBSUC2GS-20



AE-PBSC3GS-53



AE-PBSUC2GS-53

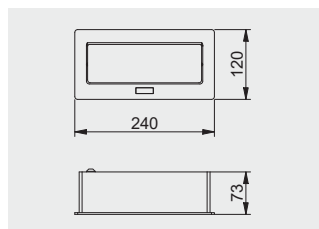

AE-PBSC3GS-10	3 x schuko	-	biały / white / белый.	stal, tworzywo steel, plastic сталь, пластмасса	
AE-PBSC3GS-20			czarny / black / черный.		
AE-PBSC3GS-53			aluminium / aluminium / алюминий.		
AE-PBSC3GU-10	3 x french		biały / white / белый.		
AE-PBSC3GU-20			czarny / black / черный.		
AE-PBSC3GU-53			aluminium / aluminium / алюминий.		
AE-PBSUC2GS-10	2 x schuko		5V USB max. 2A		biały / white / белый.
AE-PBSUC2GS-20					czarny / black / черный.
AE-PBSUC2GS-53					aluminium / aluminium / алюминий.
AE-PBSUC2GU-10	2 x french				biały / white / белый.
AE-PBSUC2GU-20					czarny / black / черный.
AE-PBSUC2GU-53					aluminium / aluminium / алюминий.



Przedłużacz biurkowy bez kasety
Through-desk power socket without housing
Настольный удлинитель без корпуса

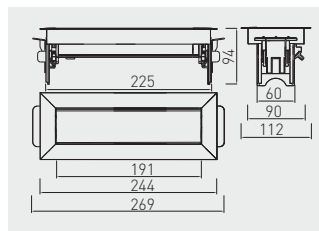

AE-PBC3GS-51BK	schuko	stal szczotkowana brushed steel шлифованная сталь	stal, aluminium, tworzywo steel, aluminium, plastic сталь, алюминий, пластмасса
AE-PBC3GU-51BK	french		



Przedłużacz biurkowy przepustowy z USB
Through-desk power socket letterbox brush cable access with USB
Настольный удлинитель с пропуском под кабель с USB

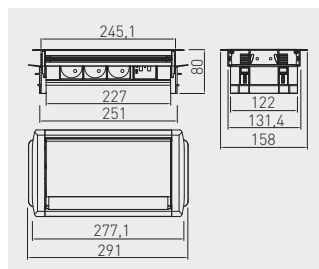

AE-PBC3GS-53BKS	schuko	-	aluminium aluminium алюминий	aluminium, tworzywo aluminium, plastic алюминий, пластмасса
AE-PBC3GU-53BKS	french	-		
AE-PBC3GS2U-53BKS	schuko	5V USB max. 2A	aluminium aluminium алюминий	aluminium, tworzywo aluminium, plastic алюминий, пластмасса
AE-PBC3GU2U-53BKS	french	5V USB max. 2A		



Przedłużacz biurkowy przepustowy z HDMI
Through-desk power socket letterbox brush cable access with HDMI port
Настольный удлинитель с пропуском под кабель, с выходом HDMI



AE-PBC2GS1HDMI-53BKS

AE-PBC2GU1HDMI-53BKS

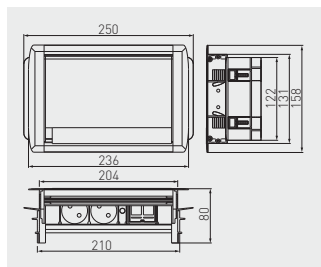

AE-PBC2GS1HDMI-53BKS	schuko	1 x HDMI	aluminium aluminium алюминий	aluminium, tworzywo aluminium, plastic алюминий, пластмасса
AE-PBC2GU1HDMI-53BKS	french			



Przedłużacz biurkowy MULTI
Power socket MULTI
Настольный удлинитель MULTI



AE-PBMUL6U6U-53

AE-PBMUL6S6U-53

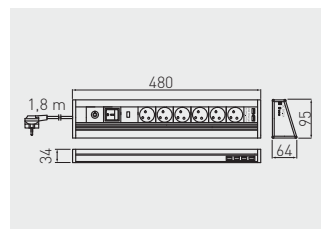

AE-PBMUL6U6U-53	french	aluminium aluminium алюминий	aluminium, tworzywo aluminium, plastic алюминий, пластмасса
AE-PBMUL6S6U-53	schuko		



Przedłużacz biurkowy kątowy MINI
 Corner power socket MINI
 Настольный удлинитель, угловой MINI

NEW

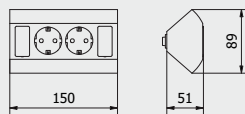

AE-PBKTM2S-80	schuko	srebrny silver серебряный.	aluminium, tworzywo aluminium, plastic алюминий, пластмасса
AE-PBKTM2F-80	french		



Przedłużacz biurkowy kątowy MINI z włącznikiem
 MINI corner power socket with switch
 MINI угловой удлинитель стола с выключателем

NEW



AE-PBKTM1SW-80

AE-PBKTM2FW-80

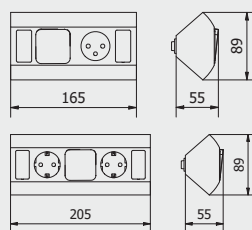

AE-PBKTM1SW-80	schuko	srebrny silver серебряный.	aluminium, tworzywo aluminium, plastic алюминий, пластмасса
AE-PBKTM1FW-80	french		
AE-PBKTM2SW-80	schuko		
AE-PBKTM2FW-80	french		



Przedłużacz biurkowy kątowy mini z regulatorem barwy
 MINI corner power socket with CCT controller
 MINI-удлинитель стола с цветным регулятором

NEW

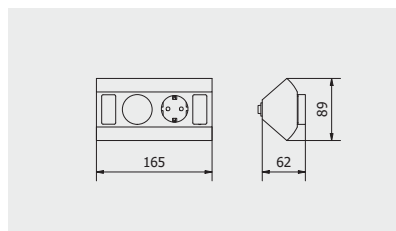

			
AE-PBKT1SCCT-80	schuko	srebrny silver серебряный.	aluminium, tworzywo aluminium, plastic алюминий, пластмасса
AE-PBKT1FCCT-80	french		



Przedłużacz BOX
 Power socket BOX
 Удлинитель BOX

NEW

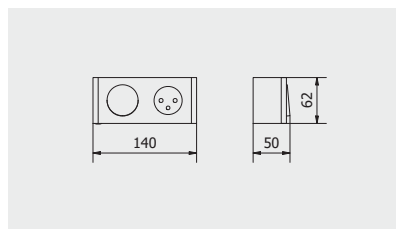

			
AE-PBOX1SW-80	schuko	srebrny silver серебряный.	aluminium, tworzywo aluminium, plastic алюминий, пластмасса
AE-PBOX1FW-80	french		



Przedłużacz biurkowy kątowy
 Corner power socket
 Настольный удлинитель, угловой



AE-PBKT4S-80

AE-PBKT3U2U-80

AE-PBKT4U-80	french	-		srebrny silver серебристый	aluminium, tworzywo aluminium, plastic алюминий, пластмасса
AE-PBKT4S-80	schuko				
AE-PBKT3U2U-80	french	5V USB max. 2A			
AE-PBKT3S2U-80	schuko				

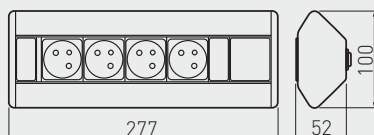



GTY



OBJAŚNIENIA IKON / ICONS EXPLANATION / ОПИСАНИЕ ИКОНОК

	indeks index индекс		szerokość width ширина		dotatkowe informacje additional information дополнительная информация
	wysokość prowadnika guide height высота чашки		wymiary (mm) dimensions (mm) размеры (мм)		stopień ochrony IP protection rating IP степень защиты IP
	wkręty zwykłe wood screws саморезы		wymiary (m) dimensions (m) размеры (м)		odległość cięcia cutting distance длина отреза
	euro wkręty euro screws евро саморезы		grubość thickness толщина		szerokość taśmy strip width ширина ленты
	pokrycie finish покрытие		szerokość zewnętrzna szafki outside width of the cabinet наружная ширина ящика		USB USB USB
	kolor color цвет		materiał material материал		rodzaj gniazda socket type тип гнезда
	obciążenie load нагрузка		wysuw extension выдвижение		moc power номинальный режим
	pojemność capacity емкость		kształt shape форма	Akcesoria meblowe Furniture accessories Мебельная фурнитура	
	siła oporu strenght сила опоры		strumień świetlny luminous flux номинальный световой поток		zawias nakładany overlay door накладная петля
	długość length длина		długość przewodu wire length длина провода		zawias bliźniaczy twin overlay полунакладная петля
	rozstaw size межцентровое расстояние		ilość diod number of diodes количество диод		zawias wpuszczany inset door вкладная петля
	wysokość height высота		kolor obudowy housing color цвет корпуса		zawias kątowy corner hinge угловая петля
	strata wysuwu extension loss потеря выдвижения		temperatura barwowa światła color temperature температура оттенка света		zawias o szerokim kącie otwarcia wide angle hinge петля с широким углом открывания
	średnica diameter диаметр		kąt świecenia beam angle угол свечения		zawias równoległy parallel hinge петля под фальшьпанель (равнолежущая)

	zawias równoległy nakładany parallel hinge for overlay door петля накладная под фальшпанель		SLIDE-ON sposób montażu slide-on slide-on mounting навдвижной монтаж slide-on		PUSH push-to-open
	zawias uzupełniający complementary hinge петля для складных дверей		SLOW zawias z mechanizmem cichego dymyku hinge with soft closing петля с доводчиком Soft Close		FULL pełny wysuw full extension полное выдвижение
	regulacja adjustment регулировка				szuflada standard standard drawer стандартный ящик
	działanie jedno-stopniowe single action hinge одношаговая петля		zawias ze sprężyną dociągającą hinge with closing spring петля с прижимной пружиной		szuflada zlewozmywakowa under sink drawer ящик под мойку
	działanie dwu-stopniowe double action hinge двухшаговая петля		zawias bez sprężyny hinge without spring петля без пружины		szuflada narożna corner drawer ящик угловой
	SPECIAL zawias do zastosowań specjalnych special hinge петля для специальных конструкций		A szuflada niska low drawer низкий ящик		szuflada standardowa standard drawer стандартный ящик
	Ø 35 mm średnica puszki hinge cup diameter диаметр чашки		B szuflada średnia medium drawer средний ящик		szuflada wewnętrzna inner drawer внутренний ящик
	45 mm rozstaw otworów puszek hinge cup drilling spacing межцентровое расстояние отверстий в чашке		C szuflada wysoka high drawer высокий ящик		przewodnica dolnego montażu under mount drawer направляющая нижнего монтажа
	montaż puszek na wkręty do drewna wood screw hinge cup mounting монтаж чашки на саморезы по дереву		regulacja pion i poziom vertical and horizontal adjustment регулировка по ширине и высоте		przewodnica kulkowa ball-bearing slide шариковая направляющая
	montaż przewodnika na wkręty do drewna wood screw mounting plate installation установка ответной планки на саморезы по дереву		opcja wypięcia release option снятие ящика без инструментов		przewodnica rolkowa roller slide роликовая направляющая
	montaż przewodnika na wkręty euro euro screw mounting plate installation установка ответной планки на евровинты		H=83 wysokość boku MB Square drawer side height MB Square высота боковой стенки MB Square		metalbox metalbox металбок
	montaż przewodnika na kołki dowel mount hinge монтаж чашки на саморезы с дюбелями		H=83 wysokość boku MB drawer side height MB высота боковой стенки MB		SLOW cichy dymyk quiet shut бесшумное закрытие
	regulacja mimośrodowa eccentric adjustment эксцентриковая регулировка		H=95 wysokość boku AXIS drawer side height AXIS высота боковой стенки AXIS		SELF CLOSING samodociąg self closing доводчик
	x 100 pakowanie packing упаковка		3D dostępna bryła 3D 3D model available есть 3D модель		montaż nasuwany ze sprzęgłem push mounting with locking device навдвижной монтаж с креплением фасада
	CLIP-ON sposób montażu clip-on clip-on mounting быстрый монтаж clip-on		CERTIFICATE 50.000 trwałość tested durability кол-во циклов откр./закр.		montaż nakładany put on mounting накладной монтаж



Oświetlenie meblowe Furniture lighting Мебельное освещение

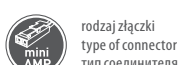
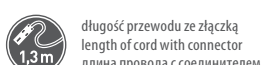
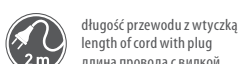
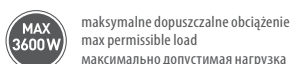
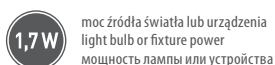
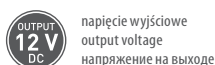
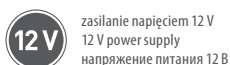
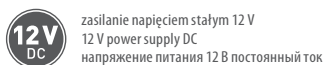
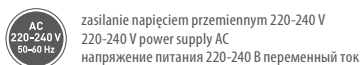
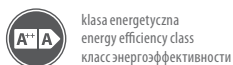



rodzaj złączki
type of connector
тип соединителя



temperatura pracy
working temperature
рабочая температура



rodzaj złączki
type of connector
тип соединителя



gniazdo USB
USB port
USB – порт



stopień ochrony IP
international protection marking
пылевлагозащита IP



maksymalne obciążenie gniazd USB
max load USB ports
максимальная нагрузка портов USB



współczynnik oddawania barw
colour rendering index
индекс цветопередачи



gniazdo UK
UK socket
гнездо UK



współczynnik mocy
power factor
коэффициент мощности



ethernet
ethernet port
ethernet – порт



liczb cykli wł./wył.
switching cycle
количество циклов вкл./выкл.



nie współpracuje ze ściemniaczami
non-dimmable
нет возможности подключения диммера



włącznik dotykowy ściemniający
dimnable touch switch
выключатель с регулятором яркости



współpracuje ze ściemniaczami
dimmable
есть возможность подключения диммера



oprawa z włącznikiem
fixture with switch
светильник с выключателем



montaż na ścianie / suficie
application: indoor / ceiling mounted
монтаж на стене / потолке



sterowanie pilotem (IR/RF)
remote control (IR/RF)
управление с помощью пульта (IR/P0)



rekomendowana odległość montażu od powierzchni
recommended mounting distance from surfaces
рекомендуется монтаж устройства на расстоянии



włącznik bezdotykowy dwubiegowy
two-pole touchless switch
бесконтактный переключатель / двухфункциональный



średnica otworu montażowego
mounting hole diameter
монтажное отверстие диаметром



włącznik do szafy / jednobiegowy
single-pole touchless switch
переключатель для шкафов / однофункциональный



akumulator
battery
аккумулятор



zasieg czujki ruchu
range of motion sensor
площадь действия сенсора



Maksymalne obciążenie na jeden kanał
Maximum load per channel
Максимальная нагрузка на один канал



czas pracy
nominal lifetime
время работы



Częstotliwość pracy pilota
Remote control frequency
Частота работы пульта



czas włączenia
starting time (max)
время включения



Maksymalna rozpraszana moc źródeł światła dla profilu rozgrzanego do maksymalnie 65 stopni C, dla wersji z kloszem.
Maximal dissipated power of lamps for heated profiles to 65°C, when applied with lampshades.
Максимальная рассеиваемая мощность источников света для нагреваемого профиля до максимум 65°C, для версии с бакуром.



trzonek źródła światła G4
base type G4
тип цоколя G4

KOLORY
COLORS
ЦВЕТА



10
biały
white
белый



80
srebrny
silver
серебристый



14
antyczna miedź
antique cooper
античная медь



10M
biały mat
white matt
белый матовый



7
antyczne srebro
antique silver
античное серебро



20
czarny
black
чёрный



mleczny
milk
молочный



19
szary mat
grey matt
серый матовый



20M
czarny mat
black matt
чёрный матовый



CS
kremowy
ecru
экрю



2, 52
satyna
satin
сатин



58
wenge
wenge
венге



1, 40
chrom
chrome
хром



6, 51
stal szczotkowana
brushed steel
шлифованная сталь



3
mosiądz
brass
латунь



5, 53
aluminium
aluminium
алюминий



11
tytan szczotkowany
brushed titanium
шлифованный титан



4
antyczny mosiądz
antique brass
античная латунь



30
szary
gray
серый



12
czarny chrom
black chrome
чёрный хром



9
antyczny mosiądz
szczotkowany
antique brushed brass
античная шлифованная латунь



ocynk
zink – plated
оцинковка



13
tytan
titanium
титан



16
złoty mosiądz
golden brass
золотая латунь



22
kość stoniowa
ivory
слоновая кость



52
wiśnia
cherry
вишня



RZ
różowy
pink
розовый



17
brąz
bronze
коричневый



42
grusza
pear
груша



PM
pomarańczowy
orange
оранжевый



50
beż
beige
кремовый



30
brąz
brown
коричневый



15
miedź
copper
медь



7, 31, 732
ciemny brąz
dark brown
темно-коричневый



44
buk
beech
бук



61
ciemny mahoń
dark mahogany
темное красное дерево



41
olcha
alder
ольха



20, 48, 731
mahoń
mahogany
красное дерево



43
jasny brąz
light brown
светло-коричневый



NB
niebieski
blue
синий



51
calvados
calvados
кальвадос



ZL
zielony
green
зеленый

Klasa ochronności na pył, ciała stałe i wodę
Dust, solids & water ingress protection rating
Класс защиты от пыли, твердых тел и воды

IP	Stopień ochrony I Protection rating I Степень защиты I
0	Brak ochrony None Отсутствие защиты
1	Ochrona przed ciałami obcymi statycznymi o wielkości ponad 50 mm. Protection against ingress of > 50 mm bodies. Защита от попадания инородных твердых тел размером более 50 мм.
2	Ochrona przed ciałami stałymi przekraczającymi 12 mm. Protection against ingress of > 12 mm bodies. Защита от попадания инородных твердых тел размером более 12 мм.
3	Ochrona przed ciałami stałymi przekraczającymi 2,5 mm. Protection against ingress of > 2.5 mm bodies. Защита от попадания инородных твердых тел размером более 2,5 мм.
4	Ochrona przed ciałami stałymi przekraczającymi 1 mm. Protection against ingress of > 1 mm bodies. Защита от попадания инородных твердых тел размером более 1 мм.
5	Pyłoodporność Protection against ingress of dust Пылестойкость
6	Pyłoszczelność Dustproof Пылестойкость

IP	Stopień ochrony II Protection rating II Степень защиты II
0	Brak ochrony None Отсутствие защиты
1	Ochrona przed pionowo wpadającymi kroplami wody. Protection against dripping water (vertically falling drops). Защита от вертикально падающих капель воды.
2	Ochrona przed kroplami wody przy przechyleniu do 15°. Protection against dripping water when tilted up to 15°. Защита от капель воды, падающих под углом до 15°.
3	Ochrona przed rozpyloną wodą Protection against spraying water. Защита от распыленной воды.
4	Ochrona przed bryzgami wody Protection against splashing of water. Защита от брызг воды.
5	Ochrona przed strugami wody Protection against water jets Защита от струй воды
6	Ochrona przed falami Protection against powerful water jets (waves) Защита от волн
7	Ochrona przed zanurzeniem Protection against immersion Защита от погружения
8	Ochrona przed głębokim zanurzeniem Protection against deep immersion Защита от глубокого погружения

Klasa ochronności przed porażeniem elektrycznym Electric shock protection class

Класс защиты от поражения электрическим током

Klasa bezpieczeństwa Safety class Класс безопасности	Symbol Symbol Символ	Wyjaśnienie Definition Пояснение
0	Brak None Нет Keine Nincs	<p>Ochronę przed porażeniem elektrycznym stanowi izolacja podstawowa. W przypadku uszkodzenia izolacji ochronę przeciwporażeniową powinny zapewnić odpowiednio korzystne warunki środowiskowe oraz położenie urządzenia poza dotykem bezpośrednim.</p> <p>The protection against electric shock relies on basic insulation only. In the event of insulation failure, electric shock protection shall be assured by suitably favourable environmental conditions and locating the equipment beyond the reach of direct touch.</p> <p>Защиту от поражения электрическим током обеспечивает основная изоляция. В случае повреждения изоляции защиту от поражения электрическим током должны обеспечить соответствующие благоприятные условия окружающей среды и размещение оборудования вне зоны прямого контакта.</p>
I		<p>W urządzeniach z I klasą ochronności bezpieczeństwo zapewnione jest przez połączenie wszystkich czynnych przewodzących elementów z przewodem ochronnym lub bezpośrednio z uziemieniem.</p> <p>Class I equipment provides protection by connecting all live conductive parts to a protective wire or directly to earth.</p> <p>В устройствах с I классом защиты безопасность обеспечивается посредством объединения всех действующих проводящих элементов с защитным проводом или непосредственно с заземлением.</p>
II		<p>W urządzeniach z II klasą ochronności bezpieczeństwo zapewnione jest przez zastosowanie izolacji podwójnej lub wzmocnionej, której w danych warunkach środowiskowych i przy napięciu znamionowym uważa się nie do przebicia.</p> <p>Class II equipment provides protection by the use of double or strengthened insulation, which is deemed breakdown-proof under given environmental conditions at the rated voltage.</p> <p>В устройствах с II классом защиты безопасность обеспечивается путем применения двойной или усиленной изоляции, которая в данных условиях окружающей среды и при номинальном напряжении считается непробиваемой.</p>
III		<p>Ochrona przeciwporażeniowa w urządzeniach z III klasy ochronności jest zapewniona przez obniżenie napięcia zasilania do wartości bezpiecznej w danych warunkach środowiskowych.</p> <p>Class III equipment protection against electric shock is provided by reduction of power voltage to a safe limit under given environmental conditions.</p> <p>Защита от поражения электрическим током в устройствах с III классом защиты обеспечивается снижением напряжения питания до безопасного в данных условиях окружающей среды значения.</p>

Indeks

A

A-B63-32	446	AE-PBC3GU-53	537	AE-ZLADLUX-40	529	A-LD10FL-235-05	433
A-B63-40	446	AE-PBC3GU-53BKS	540	AE-ZLADPOD-20	529	A-LD10FL-235-90	433
A-BUDP-SET	452	AE-PBKT3S2U-80	544	AE-ZUSB-20	528	A-LD10FL-300-05	433
A-BUD-UB	452	AE-PBKT3U2U-80	544	A-H16-300-05	434	A-LD10FL-300-10	433
A-BUD-UG	452	AE-PBKT4S-80	544	A-H16-300-90	434	A-LD10FL-300-90	433
A-BUD-UM	452	AE-PBKT4U-80	544	A-H18-300-05	436	A-LD18-170-05	429
A-BUD-UP	452	AE-PBKT1FCCT-80	543	A-H18-300-10	436	A-LD18-170-90	429
A-BUD-UR	452	AE-PBKT1FW-80	542	A-H18-300-20M	436	A-LD18-235-05	429
A-C18-300-S-05	434, 449, 450	AE-PBKT1SCCT-80	543	A-H18-300-90	436	A-LD18-235-90	429
A-C18-300-S-10	434	AE-PBKT1SW-80	542	A-HR10-235-05	437	A-LD18-300-05	429
A-C18-300-S-20M	434	AE-PBKT2F-80	542	A-HR10-235-90	437	A-LD18-300-10	429
A-C18-300-S-90	434	AE-PBKT2FW-80	542	A-HR10-300-05	437	A-LD18-300-20M	429
A-DPG-16	439	AE-PBKT2S-80	542	A-HR10-300-10	437	A-LD18-300-90	429
AE-BPW1S1UCH-51	530	AE-PBKT2SW-80	542	A-HR10-300-90	437	A-LD18-405-05	429
AE-BPW1S1UCH-53	532	AE-PBMUL6S6U-53	541	A-HR10-405-05	437	A-LD18-405-10	429
AE-BPW1S2UCH-80	530	AE-PBMUL6U6U-53	541	A-HR10-405-90	437	A-LD18-405-90	429
AE-BPW1U1UCH-51	530	AE-PBOX1FW-80	543	A-HR10-600-05	437	A-LD18-600-05	429
AE-BPW1U1UCH-53	532	AE-PBOX1SW-80	543	A-HR10-600-90	437	A-LD18-600-90	429
AE-BPW1U2UCH-80	530	AE-PBSC3GS-10	539	A-HR10FL-300-05	438	A-LD19-300-05	430
AE-BPW3GS-20	534	AE-PBSC3GS-20	539	A-HR10FL-300-10	438	A-LG4MOV-300-05	431
AE-BPW3GS-80	534	AE-PBSC3GS-53	539	A-HR10FL-300-90	438	A-LG10-170-05	430
AE-BPW3GU-20	534	AE-PBSC3GU-10	539	A-HR18-300-05	436	A-LG10-235-05	430
AE-BPW3GU-80	534	AE-PBSC3GU-20	539	A-HR18-300-10	436	A-LG10-235-90	430
AE-BPW3S60-20	536	AE-PBSC3GU-53	539	A-HR18-300-20M	436	A-LG10-300-05	430
AE-BPW3S60-80	536	AE-PBSUC2GS-10	539	A-HR18-300-90	436	A-LG10-300-10	430
AE-BPW3S60U-20	536	AE-PBSUC2GS-20	539	A-HR19-300-05	437	A-LG10-300-90	430
AE-BPW3S60U-80	536	AE-PBSUC2GS-53	539	A-HRS10-170-05	437	A-LG10-405-05	430
AE-BPW3S100U-53	532	AE-PBSUC2GU-10	539	A-HRS10-300-05	437	A-LG10-405-90	430
AE-BPW3U60-20	536	AE-PBSUC2GU-20	539	A-HRS10-300-90	437	A-LG10-600-05	430
AE-BPW3U60-80	536	AE-PBSUC2GU-53	539	A-HRS10-405-05	437	A-LG10-600-90	430
AE-BPW3U100U-53	532	AE-PBU2GU-10	537	A-HRS10-600-05	437	A-LG10FL-235-05	432
AE-BPW3U60-20	536	AE-PBU2GU-20	537	A-HRS18-170-05	436	A-LG10FL-235-90	432
AE-BPW3U60-80	536	AE-PBU2GU-53	537	A-HRS18-170-90	436	A-LG10FL-300-05	432
AE-BPW3U60U-20	536	AE-WBBUNI-10DIM	519	A-HRS18-235-05	436	A-LG10FL-300-10	432
AE-BPW3U60U-80	536	AE-WBCUNI-10DIM	519	A-HRS18-235-90	436	A-LG10FL-300-90	432
AE-BPW3U100U-53	532	AE-WBEZDB-10S	517	A-HRS18-300-05	436	A-LG18-170-05	428
AE-BPW4S100-53	532	AE-WBEZDC-10S	517	A-HRS18-300-90	436	A-LG18-170-90	428
AE-BPW4U100-53	532	AE-WBEDDK15-10	517	A-K18-300-05	433	A-LG18-235-05	428
AE-PB02GS-53	538	AE-WBEZD-NB	520	A-K18-300-10	433	A-LG18-235-90	428
AE-PB02GSHDMI-53	538	AE-WBEZDPIR2-20	518	A-K18-300-20M	433	A-LG18-300-05	428
AE-PB02GU-53	538	AE-WBEZDPIR-10	518	A-K18-300-90	433	A-LG18-300-10	428
AE-PB03GS-53	537	AE-WDBP1-10	516	A-KLP-4	444	A-LG18-300-20M	428
AE-PB03GU-53	537	AE-WDBP1-20	516	A-KR-4	444	A-LG18-300-90	428
AE-PBC2GS1HDMI-53BKS541	538	AE-WDBP2CCT-10	516	A-LD4MOV-300-05	432	A-LG18-405-05	428
AE-PBC2GSHDMI-53	538	AE-WDBP2CCT-20	516	A-LD10-170-05	431	A-LG18-405-10	428
AE-PBC2GU1HDMI-53BKS541	538	AE-WDSB-10DIM	519	A-LD10-235-05	431	A-LG18-405-90	428
AE-PBC2GU-53	538	AE-WDSC-10DIM	519	A-LD10-235-90	431	A-LG18-600-05	428
AE-PBC2GUHDMI-53	538	AE-WLB01-10	522	A-LD10-300-05	431	A-LG18-600-90	428
AE-PBC3GS2U-53BKS	540	AE-WLC01-20	522	A-LD10-300-10	431	A-LG19-300-05	429
AE-PBC3GS-51BK	540	AE-WLKON-20	522	A-LD10-300-90	431	AM-ADAP0A-10	41
AE-PBC3GS-53BKS	540	AE-WLLAN1-10	523	A-LD10-405-05	431	AM-ADAP0A-60	41
AE-PBC3GU2U-53BKS	540	AE-WLPR-60	521	A-LD10-405-90	431	AM-ADAP0B-10	41
AE-PBC3GU-10	537	AE-WLPR-60P2	521	A-LD10-600-05	431	AM-ADAP0B-60	41
AE-PBC3GU-20	537	AE-WPDRW-00	520	A-LD10-600-90	431	A-MEVO-170-05	426
AE-PBC3GU-51BK	540						

A-MEVO-170-10A	426	A-MPRO-300-90	428	A-R18NOVS-270-20M	419	A-TDEVO-300-90	426
A-MEVO-170-20M	426	A-MPRO-405-05	428	A-R18NOVS-270-90	419	A-TDEVO-405-05	426
A-MEVO-170-90	426	A-MPRO-405-10	428	A-R18VIS-270-05	420	A-TDEVO-405-10	426
A-MEVO-235-05	426	A-MPRO-405-20M	428	A-R18VIS-270-90	420	A-TDEVO-405-20M	426
A-MEVO-235-10A	426	A-MPRO-405-90	428	A-R19NERO-300-05	421	A-TDEVO-405-90	426
A-MEVO-235-20M	426	AM-PROST-KPL	39	A-R19NOVS-300-05	420	A-TDEVO-600-05	426
A-MEVO-235-90	426	AMR-BP-0715	45	A-RD-MITO	448	A-TDEVO-600-10	426
A-MEVO-300-05	426	AMR-BP-1003	45	A-RNOV2-270-05	419	A-TDEVO-600-20M	426
A-MEVO-300-10A	426	AMR-WP-00	45	A-RNOV2-270-10	419	A-TDEVO-600-90	426
A-MEVO-300-20M	426	AMS-MPST001-OC	400	A-RNOV2-270-90	419	A-TDPRO-170-05	427
A-MEVO-300-90	426	A-MSOFT-ADAPT	447	A-SG-MITO	448	A-TDPRO-170-10	427
A-MEVO-405-05	426	A-MSOFT-RAMA	447	A-SN-ADSET	449, 450	A-TDPRO-170-20M	427
A-MEVO-405-10	426	AM-ZAT-A1-10	44	A-SN-FSET	449	A-TDPRO-170-90	427
A-MEVO-405-20M	426	A-PG-18	438	A-SN-HSET1	450	A-TDPRO-235-05	427
A-MEVO-405-90	426	A-PGR-10	439	A-SN-K19-270-05	449, 450	A-TDPRO-235-10	427
A-MITO-PLUS	448	A-PGR-105	439	A-SN-LOFT-200-20M	453	A-TDPRO-235-20M	427
AM-KRZYZ-KPL	40	A-PGR-18	438	A-SN-POZ	450	A-TDPRO-235-90	427
AM-MBSOFT-P2	87	A-POZ-MITO	448	A-SN-R19RIV-270-05	449, 450	A-TDPRO-300-05	427
AM-OAM-DL-GM-10	43	A-PTD 442		A-SN-SDP-TU	451	A-TDPRO-300-10	427
AM-OAM-DL-GM-30	43	A-PTG 441		A-SN-SOFT-25	449, 450	A-TDPRO-300-20M	427
AM-OAM-DL-GM-60	43	A-PW-RC-DOC	447	A-SN-SOFT-40	449, 450	A-TDPRO-300-90	427
AM-OAM-DL-MG-10	43	A-R4MOV-270-05	422	A-SN-TDS-405-00	449	A-TDPRO-405-05	427
AM-OAM-DL-MG-30	43	A-R10ARCO-270-05	424	A-SN-TDT-405-00	450	A-TDPRO-405-10	427
AM-OAM-DL-MG-60	43	A-R10ARCO-270-90	424	A-SN-TG-405-00	449, 450	A-TDPRO-405-20M	427
AM-OAM-KR-GM-10	43	A-R10FALDA-270-05	424	A-SO-48X4	442	A-TDPRO-405-90	427
AM-OAM-KR-GM-30	43	A-R10FALDA-270-90	424	A-SO-145X4	442	A-TDPRO-600-05	427
AM-OAM-KR-GM-60	43	A-R10FL-270-05	422	A-SO-145X4-10	442	A-TDPRO-600-10	427
AM-OAM-KR-MG-10	43	A-R10FL-270-10	422	A-SO-145X4-20	442	A-TDPRO-600-20M	427
AM-OAM-KR-MG-30	43	A-R10FL-270-90	422	A-SOFT-30	446	A-TDPRO-600-90	427
AM-OAM-KR-MG-60	43	A-R10FORM-270-05	423	A-SOFT-50	446	A-TG-170-05	425
AM-ODB000-10	40	A-R10FORM-270-90	423	A-SP-7X12	443	A-TG-170-10	425
AM-ODB000-60	40	A-R10NOV-270-05	423	A-SP-48X7	443	A-TG-170-20M	425
AM-OWM-DL-GM-10	42	A-R10NOV-270-10	423	A-SP-48X12	443	A-TG-170-90	425
AM-OWM-DL-GM-30	42	A-R10NOV-270-90	423	A-T18-300-05	434	A-TG-235-05	425
AM-OWM-DL-GM-60	42	A-R10TORO-270-05	424	A-T18-300-10	434	A-TG-235-10	425
AM-OWM-DL-MG-10	42	A-R10TORO-270-90	424	A-T18-300-90	434	A-TG-235-20M	425
AM-OWM-DL-MG-30	42	A-R10TRAF0-270-05	423	A-TDEVO2-170-05	427	A-TG-235-90	425
AM-OWM-DL-MG-60	42	A-R10TRAF0-270-90	423	A-TDEVO2-170-90	427	A-TG-300-05	425
AM-OWM-KR-GM-10	42	A-R16ERG-220-05	418	A-TDEVO2-235-05	427	A-TG-300-10	425
AM-OWM-KR-GM-30	42	A-R16ERG-230-50	418	A-TDEVO2-235-90	427	A-TG-300-20M	425
AM-OWM-KR-GM-60	42	A-R16ERG-270-50	418	A-TDEVO2-300-05	427	A-TG-300-90	425
AM-OWM-KR-MG-10	42	A-R16ERG-270-90	418	A-TDEVO2-300-90	427	A-TG-405-05	425
AM-OWM-KR-MG-30	42	A-R18CARO-270-05	420	A-TDEVO2-405-05	427	A-TG-405-10	425
AM-OWM-KR-MG-60	42	A-R18CARO-270-90	420	A-TDEVO2-405-90	427	A-TG-405-20M	425
AM-PLA-DLU-0	44	A-R18COTE-270-05	421	A-TDEVO2-600-05	427	A-TG-405-90	425
AM-PL-DL-MAG	44	A-R18COTE-270-90	421	A-TDEVO2-600-90	427	A-TG-600-05	425
A-MPRO-170-05	428	A-R18ERG-270-05	418	A-TDEVO-170-05	426	A-TG-600-10	425
A-MPRO-170-10	428	A-R18ERG-270-90	418	A-TDEVO-170-10	426	A-TG-600-20M	425
A-MPRO-170-20M	428	A-R18EO2-270-05	418	A-TDEVO-170-20M	426	A-TG-600-90	425
A-MPRO-170-90	428	A-R18LOCA-305-05	422	A-TDEVO-170-90	426	A-TG-BUD-200-00	452
A-MPRO-235-05	428	A-R18LOCA-305-90	422	A-TDEVO-235-05	426	A-TG-BUD-300-00	452
A-MPRO-235-10	428	A-R18NERO-270-05	421	A-TDEVO-235-10	426	A-TMITO-200-00	448
A-MPRO-235-20M	428	A-R18NERO-270-10	421	A-TDEVO-235-20M	426	A-TMITO-200-00*	448
A-MPRO-235-90	428	A-R18NERO-270-20M	421	A-TDEVO-235-90	426	A-TMITO-200-05	448
A-MPRO-300-05	428	A-R18NERO-270-90	421	A-TDEVO-300-05	426	A-TMITO-250-00	448
A-MPRO-300-10	428	A-R18NOVS-270-05	419	A-TDEVO-300-10	426	A-TMITO-250-00*	448
A-MPRO-300-20M	428	A-R18NOVS-270-10	419	A-TDEVO-300-20M	426	A-TMITO-250-05	448

A-TMITO-300-00	448	GZ-CRPB30-A1	342	K		KO-1502MD-CR	236
A-TMITO-300-05	448	GZ-CRPB40-01	342	KK-D50-80-06	260	KO-1502MD-SR	236
A-USZCZ-CHM4	445	GZ-CRPB40-A1	342	KK-D50100-06	260	KO-2002BO-10	235
A-USZCZ-TDEVO2	445	GZ-CRPC30-01	343	KK-W60245-M0	259	KO-2002BO-CR	235
A-USZCZ-U4	445	GZ-CRPC30-A1	343	KK-W60245-M1	259	KO-2002BO-SR	235
A-WD-EVO2	440	GZ-FROSI-1-04	337	KK-W60245-M2	259	KO-2002MD-CR	236
A-WD-PRO	440	GZ-FROSI-1-09	337	KK-W60245-M6	259	KO-2002MD-SR	236
A-WDR-EVO	441	GZ-HILL-1-01	267	KK-W60800-M0	261	KO-3002BO-10	235
A-WDR-PRO	441	GZ-HILL-1-05	267	KK-W60800-M1	261	KO-3002BO-CR	235
A-ZAC-WDEVO2	440	GZ-HILL-1-06	267	KK-W80800-D0	261	KO-3002BO-SR	235
A-ZAT-TDEVO2	444	GZ-HILL-1-12	267	KK-W80800-D1	261	KO-3002MD-CR	236
		GZ-IMOLA-1-01	275	KM-00-40-D20	410	KO-3002MD-SR	236
B		GZ-IMOLA-1-02	275	KM-00-50-D20	410	KO-4002MD-CR	236
BP-SLZIGW-10	392	GZ-IMOLA-1-05	275	KM-0H-40-D20	410	KO-4002MD-SR	236
BP-SLZIGW-21	393	GZ-IMOLA-1-06	275	KM-0H-50-D20	410	KO-5002MD-CR	236
		GZ-MILAN-32-01	282	KM-015030-10	410	KO-5002MD-SR	236
E		GZ-MILAN-32-05	282	KM-015030-20	410	KO-6002MD-CR	236
EM-SBL060-01	153	GZ-MILAN-32-06	282	KM-015038-10	410	KO-6002MD-SR	236
EM-SBL100-01	153	GZ-MILAN-32-20M	282	KM-015038-GM	411	KO-CMB150-PW-01	237
EM-SBL150-01	153	GZ-OLBIA-1-04	330	KM-A035MM-00	411	KO-CMB150-PW-OC	237
		GZ-OLIVA-16-01*	268	KM-A035MM-30	411	KO-CMB200-PW-01	237
G		GZ-PALER-1-07	322	KM-A050MM-00	412	KO-CMB200-PW-10	237
GA-IMPER-1-02B	338	GZ-ROMA-1-01	275	KM-A050MM-30	412	KO-CMB200-PW-OC	237
GA-IMPER-1-11	338	GZ-ROMA-1-02	275	KM-AH35MM-00	411	KO-CMB300-PW-01	237
GA-IMPER-1-20M	338	GZ-ROMA-1-05	275	KM-AH35MM-30	411	KO-CMB300-PW-OC	237
GP-0728-J4-A-04	320	GZ-ROMA-1-06	275	KM-AH50MM-00	412	KO-CMB300-PW-10	237
GP-0728-J4-A-07	320	GZ-ROYAL3-1-10-03	333	KM-AH50MM-30	412	KO-CMB300-PW-OC	237
GP-0728-J4-B	320	GZ-TERNI-1-01	308	KM-B050MM-00	412	KO-SRH4550-40-OC	206
GP-0728-J4-C-04	320	GZ-TERNI-1-02	308	KM-B050MM-30	412	KO-SRH4550-50-OC	206
GP-0728-J4-R	320	GZ-TERNI-1-05	308	KM-B075MM-00	413	KO-SRH4550-60-OC	206
GS-BERGA-1-01	307	GZ-TERNI-1-06	308	KM-B075MM-30	413	KO-SRH45200-40-OC	206
GS-BERGA-1-02	307	GZ-TERNI-1-09	308	KM-BH50MM-00	412	KO-SRH45200-50-OC	206
GS-BERGA-1-05	307	GZ-TERNI-1-10	308	KM-BH50MM-30	412	KO-SRH45200-60-OC	206
GS-BERGA-1-06	307	GZ-TERNI-1-12	308	KM-BH75MM-00	413	KO-SRPR100-30-10	205, 207
GS-BERGA-1-10	307	GZ-TERNI-1-20M	308	KM-BH75MM-30	413	KO-SRPR100-30-OC	205, 207
GS-BERGA-1-12	307	GZ-UDINE-1-01	307	KM-GREYROLL-50mm-BH415	415	KO-SRPR100-40-10	205, 207
GS-BERGA-1-20M	307	GZ-UDINE-1-02	307	KM-GREYROLL-50mm-ZH415	415	KO-SRPR100-40-OC	205, 207
GZ-71C024-01	338	GZ-UDINE-1-05	307	KM-GREYROLL-75mm-BH415	415	KO-SRPR100-50-10	205, 207
GZ-ARDEA-1-09	324	GZ-UDINE-1-06	307	KM-GREYROLL-75mm-ZH415	415	KO-SRPR100-50-OC	205, 207
GZ-CENTO-1-04	337	GZ-UDINE-1-10M	307	KM-RD-35-CF	413	KO-SRPR100-60-10	205, 207
GZ-CENTO-1-07	337	GZ-UDINE-1-12	307	KM-RD-35-CF-20	413	KO-SRPR100-60-OC	205, 207
GZ-CENTO-1-14	337	GZ-UDINE-1-20M	307	KM-RD-35-SF	413	KO-SRPR150-30-10	205, 207
GZ-CENTO-1-20M	337	GZ-VETA-1-01	266	KM-RD-35-SF-20	413	KO-SRPR150-30-OC	205, 207
GZ-CLEO-1-01	266	GZ-VETA-1-05	266	KM-RD-50-CF	414	KO-SRPR150-40-10	205, 207
GZ-CLEO-1-05	266	GZ-VETA-1-12	266	KM-RD-50-CF-20	414	KO-SRPR150-40-OC	205, 207
GZ-CLEO-1-06	266	GZ-WP1136-04	334	KM-RD-50-SF	414	KO-SRPR150-50-10	205, 207
GZ-CRPA20-01	342	GZ-WP1148-04	335	KM-RD-50-SF-20	414	KO-SRPR150-50-OC	205, 207
GZ-CRPA25-01	342	GZ-WP1152-04	335	KM-RD-75-CF	414	KO-SRPR150-60-10	205, 207
GZ-CRPA30-01	342	GZ-WP1155-01	308	KM-RD-75-CF-20	414	KO-SRPR150-60-OC	205, 207
GZ-CRPA30-03	342	GZ-ZH-011-01A	309	KM-RD-75-SF	414	KO-SRPR200-30-10	205, 207
GZ-CRPA30-A1	342	GZ-ZH-011-05A	309	KM-RD-75-SF-20	414	KO-SRPR200-30-OC	205, 207
GZ-CRPA40-01	342			KM-SPAIN-40MM-18	415	KO-SRPR200-40-10	205, 207
GZ-CRPB20-01	342	H		KM-SPAIN-50MM-18	415	KO-SRPR200-40-OC	205, 207
GZ-CRPB25-01	342	HB-USB-4X-20	247	KO-1502BO-10	235	KO-SRPR200-50-10	205, 207
GZ-CRPB25-A1	342	HB-USB-4X-60	247	KO-1502BO-CR	235	KO-SRPR200-50-OC	205, 207
GZ-CRPB30-01	342	HRS18-235-90	436	KO-1502BO-SR	235	KO-SRPR200-60-10	205, 207
GZ-CRPB30-03	342					KO-SRPR200-60-OC	205, 207

KO-UMC4645C	234	LD-2835-600-20-ZB	456, 457	LD-KONML-WRGB-PAN	512	LD-WZA80W-NW	507
KO-UMC4840SC	234	LD-2835-600-65-CB	456, 457	LD-KWP27CB-53	494	LD-WZA150W-NW	507
KT-APRIL-1-04	326	LD-2835-600-65-ZB	456, 457	LD-KWP27ZB-53	494	LD-Z3CSCB-53	492
KT-WP1147-04	336	LD-3014-1200-20-CB	457	LD-LCG319-40	493	LD-Z5CSCB-53	492
KW-FS0125-01	145	LD-3014-1200-20-NE4	457	LD-LCG319-52	493	LD-ZAC6WDE-RGB	510
KW-FS0140-01	145	LD-3014-1200-20-ZB	457	LD-LCG319-53	493	LD-ZAS24PRO80W-30	504
KW-FS0335-01	146	LD-3528-300-20-CB	456	LD-LU16CB-53	487	LD-ZAS75W-30	504
KW-FS0350-01	146	LD-3528-300-20-CB-50	458	LD-LU16NE-53	487	LD-ZAS150-NW	506
KW-FS0375-01	146	LD-3528-300-20-NE4P	456	LD-LU16ZB-53	487	LD-ZAS350-NW	506
KW-FS0425-03	146	LD-3528-300-20-NE4P-50	458	LD-LUG319-40	493	LD-ZASPRO07W-30	503
KW-FS0430-03	146	LD-3528-300-20-NI	456	LD-LUG319-52	493	LD-ZASPRO12W-30	503
KW-FS0440-03	146	LD-3528-300-20-ZB	456	LD-LUG319-53	493	LD-ZASPRO16W-30	503
KW-FS0450-03	146	LD-3528-300-20-ZB-50	458	LD-MAX60CB-40N	497	LD-ZASPRO24W-30	503
KW-FS0460-03	146	LD-3528-300-65-CB	456	LD-MAX60ZB-40N	497	LD-ZASPRO33W-30	503
KW-FS0475-03	146	LD-3528-300-65-ZB	456	LD-NKW18CB-40	500	LD-ZASPRO054W-30	503
KW-FS0650-01	147	LD-3528-600-20-CB	456	LD-NKW18ZB-40	500	LD-ZASPRO65W-30	503
		LD-3528-600-20-ZB	456	LD-NO24CB-00	499	LD-ZASPRO80W-30	503
		LD-3528-600-65-CB	456	LD-NO24ZB-00	499	LD-ZASPU15W-30N	507
		LD-3528-600-65-ZB	456	LD-OBP27CB-53	493	LD-ZL5RGB150-00	510
LB-80X160-05	248	LD-5050-300-20-CB	457	LD-OBP27ZB-53	493	LD-ZSKL15-00	508
LB-80X160-20	248	LD-5050-300-20-ZB	457	LD-OJVCOB-CB	488	LD-ZTK8MM-02N	526
LB-80X280-05	249	LD-5050-300-65-CB	457	LD-OP408C-53	495	LD-ZTK8MM-02N600	526
LB-80X280-20	249	LD-5050-300-65-ZB	457	LD-OP456C-53	495	LD-ZTK10MM-02N	526
LB-80X500-05	249	LD-5630-300-20-CB	457	LD-OP609C-53	495	LD-ZTKS8MM-02N	528
LB-80X500-20	249	LD-5630-300-20-ZB	457	LD-OPD5W0-CB	496	LD-ZTKT8MM-02N	526
LB-K80X80-05	247	LD-5630-300-65-CB	457	LD-OPD9W0-CB	496	LD-ZTKT8MM-02N600	526
LB-K80X80-20	247	LD-5630-300-65-ZB	457	LD-OPT305-53N	491	LD-ZTKT10MM-02N	526
LB-K80X100-05	248	LD-AB18CB-53	498	LD-OPT60S-51N	491	LD-ZTKTRGB-04N	526
LB-K80X100-20	248	LD-AB18ZB-53	498	LD-OPT60S-53N	491	LD-ZTL8MM-02N	525
LD-3SKL-CBN	502	LD-AL24CB-53	490	LD-PIRUSB-53	500	LD-ZTL8MM-02N600	525
LD-3SKL-NBN	502	LD-AL24NE-53	490	LD-PJVCOB-CB	488	LD-ZTL8MMAMP-02N	527
LD-3SKL-ZBN	502	LD-AL24ZB-53	490	LD-RA60CB-40N	497	LD-ZTL8MMAMP-02N600	527
LD-2835-24V-300-20-CB	458	LD-BOS1CBWB-53	501	LD-RA60ZB-40N	497	LD-ZTL10MM-02N	525
LD-2835-24V-300-20-NE4	458	LD-BOS1CBWG-53	501	LD-RGB-150-20	457	LD-ZTL82M-2N	527
LD-2835-24V-300-20-ZB	458	LD-CHIC16NE-10	501	LD-RGB-150-65	457	LD-ZTL82M-2N600	527
LD-2835-24V-600-20-CB	458	LD-CHIC16NE-20	501	LD-SR16CB-53	496	LD-ZTL102M-2N	527
LD-2835-24V-600-20-NE4	458	LD-CS36CB-53	489	LD-SR16NE-53	496	LD-ZTLR82M-4N	527
LD-2835-24V-600-20-ZB	458	LD-CS36NE-53	489	LD-SR16ZB-53	496	LD-ZTLR82M-04N	525
LD-2835-60-60-20-CCT	457	LD-CS36ZB-53	489	LD-SZAHQ06W-MA	505	LD-ZTL82M-02N	528
LD-2835-300-20-CB	456	LD-DIMLED-10	521	LD-SZAHQ15W-MA	505	LD-ZTL82M-02N600	528
LD-2835-300-20-CB-50	458	LD-EIW09CB-CZ	498	LD-SZAHQ30W-MA	505	LD-ZTL82M-2N	528
LD-2835-300-20-CBN	456	LD-FL36CB-00	499	LD-SZAHQ50W-MA	505	LD-ZWIND6W-10	508
LD-2835-300-20-NE4N	456	LD-FL36ZB-00	499	LD-SZAHQ75W-MA	505	LD-ZWIND12-10	508
LD-2835-300-20-NE4P	456	LD-IRUSB-53	500	LD-TR24CB-53	491	LD-ZZAS07PROKD6	505
LD-2835-300-20-NE4P-50	458	LD-KABE2M-00	523	LD-TR24NE-53	491	LD-ZZAS12PROKD6	505
LD-2835-300-20-ZB	456	LD-KJVCOB-CB	487	LD-TR24ZB-53	491	LD-ZZAS16PROKD6	505
LD-2835-300-20-ZB-50	458	LD-KJVCOB-ZB	487	LD-VA24CB-53	486	LD-ZZAS24PROKD6	505
LD-2835-300-20-ZBN	456	LD-KLPCB-00N	502	LD-VA24NE-53	486	LD-ZZAS33PROKD6	505
LD-2835-300-65-CB	456	LD-KLPNB-00N	502	LD-VA24ZB-53	486	LMB-BOCZ38L-ALU	161
LD-2835-300-65-CBN	456	LD-KLPZB-00N	502	LD-VE15CB-53	489	LMB-BOCZ38P-ALU	161
LD-2835-300-65-NE4N	456	LD-KONMINI-RGB	509	LD-VE15CBZB-53	490	LMB-KAT28-ALU	161
LD-2835-300-65-ZB	456	LD-KONML-AD	515	LD-VE15NE-53	489	LMB-KAT38-ALU	162
LD-2835-300-65-ZBN	456	LD-KONML-MONO	514	LD-VE15ZB-53	489	LMB-SZCZ28-ALU	162
LD-2835-600-5MM-20-CB	457	LD-KONML-MONO-PAN	514	LD-WL2457-53	494	LMB-SZCZ38-ALU	163
LD-2835-600-5MM-20-NE4457	457	LD-KONML-MONO-PIL	515	LD-WZA20W-NW	507	LO-00-00-001	160
LD-2835-600-5MM-20-ZB	457	LD-KONML-RGBW	512	LD-WZA36W-NW	507	LO-00-00-003	160
LD-2835-600-20-CB	456, 457	LD-KONML-RGBW-PIL	513	LD-WZA60W-NW	507	LO-M2M-00-125	152

LO-P0-00-010	160	MP-118500-10	83	NM-60R820-05	408	NM-BD-003-150-01	373
LO-P0-00-030	160	MP-150350-10	83	NM-60R1100-05	408	NM-BD-003-150-02	373
LZ-AKZ312-10N	524	MP-150400-10	83	NM-60R1100-20	408	NM-BD-100-01	375
LZ-AKZ612-10N	525	MP-150450-10	83	NM-380X730-01	409	NM-BD-100-02	375
LZ-KAPR2M-10	524	MP-150500-10	83	NM-480X730-01	409	NM-BD-100-05	375
		MR-R0050-001	166	NM-A60710-01	401	NM-BD-100-06	375
		MR-RDRO-0000	164	NM-A60710-02	401	NM-BD-150-01	372
		MR-RS025-001	165	NM-A60710-05	401	NM-BD-150-02	372
MA-MATA-0-00	245	MR-RS025-10	191	NM-A60710-10	401	NM-BD-712-M1	383
MC-J01A-12-01	136	MR-RS025-60	191	NM-A60710-20	401	NM-BD727-100	380
MC-J01A-12-06	136	MR-T1824-KPL	172	NM-A60710-80	401	NM-BD-739-05	381
MC-J01A-16-01	136	MR-TDL011-01	140	NM-A60820-01	401	NM-BD-762-01	376
MC-J01A-19-01	136	MR-TH001-01	176	NM-A60820-02	401	NM-BD-762-05	376
MC-J01A-19-06	136	MR-TH002-L01	176	NM-A60820-05	401	NM-BD-780-M1	373
MC-J01A-25-01	136	MR-TH002-P01	176	NM-A60820-10	401	NM-BD-780-M2	373
MC-J01A-25-06	136	MR-TH004-001	171	NM-A61100-01	401	NM-BD-780-M5	373
MC-J04A2-14-01	137	MR-TH005-001	170	NM-A61100-02	401	NM-BD867-100	376
MC-J04A2-14-05	137	MR-TH009-001	173	NM-A61100-05	401	NM-BD868-100	377
MC-J04A2-18-01	137	MR-TH010-001	174	NM-A61100-06	401	NM-BD868-150	377
MC-J04A2-22-01	137	MR-TH011-001	173	NM-A61100-10	401	NM-BD869-150	377
MC-J60A27-01	137	MR-TH016-001	170	NM-A61100-20	401	NM-DAK27-060	381
MC-J60A27-05	137	MR-TH018-KPL	171	NM-A80710-01	402	NM-DAK27-080	381
MC-J62-01	138	MR-TH018-L01	177	NM-A80710-02	402	NM-DAK27-100	381
MC-J63-01	134	MR-TH018-P01	177	NM-A80710-03	402	NM-DAK27-120	381
MC-J63-05	134	MR-TH019-001	178	NM-A80710-05	402	NM-DAK27-150	381
MC-J65-08-01	135	MR-TH019-003	178	NM-A80710-06	402	NM-DAP77-60	378
MC-J65-08-05	135	MR-TH024-KPL	172	NM-A80710-10	402	NM-DAP77-100	378
MC-J65-10-01	135	MR-TH035-KPL	174	NM-A80710-20	402	NM-DAP77-150	378
MC-J65-10-05	135	MR-TH048-001	179	NM-A80710-80	402	NM-DPA20-100	396
MC-J65-12-01	135	MR-THA12-001	168	NM-A80870-01	402	NM-DPA20-100W	396
MC-J65-12-05	135	MR-THB12-001	169	NM-A80870-02	402	NM-DPA20-150	396
MC-J123-01	135	MR-THQZ1-001	177	NM-A80870-03	402	NM-DPA20-150W	396
MC-J123-05	135	MR-WP-010-01	167	NM-A80870-05	402	NM-DPD20-100	395
MC-K090-AR-01	138	MR-WP-011-01	168	NM-A80870-06	402	NM-F50710-01	405
MC-K091-SQ-01	139	MR-WP013-001	169	NM-A80870-10	402	NM-F50710-06	405
MC-K135-06-01	136	MR-WP-14-KPL	175	NM-A80870-20	402	NM-F50710-10	405
MG-MENSA-010	158	MR-WP-15-KPL	175	NM-A80870-80	402	NM-F50710-20	405
MG-MENSA-030	158	MR-WP-028-01	164	NM-B1-140-060-A	374	NM-F50870-01	405
MM-FI20-KPL	154	MR-WP2802-01	180	NM-B1-140-080-A	374	NM-F50870-06	405
MM-FI20X6X7-PL10	153	MR-WP2804-01	181	NM-B1-140-100-A	374	NM-F50870-10	405
MM-FI20X6X7-PL20	153	MR-WP2806-01	181	NM-B1-140-120-A*	374	NM-F50870-20	405
MM-FI20X6X7-PL30	153	MR-WP2807-20	182	NM-B1-140-150-A	374	NM-G60710-01N	403
MM-FI20X6X7-PL80	153	MR-WP2815-01	180	NM-B1-140-180-A	374	NM-G60710-02N	403
MM-FI20X6X7-ZN	153	MR-WPS01-001	183	NM-B1-140-200-A	374	NM-G60710-03N	403
MP-054350-10	83	MR-WPS03-001	183	NM-B103-80-01	372	NM-G60710-05N	403
MP-054400-10	83	MR-WPZ002-01	166	NM-B103-80-06	372	NM-G60710-06N	403
MP-054450-10	83	MR-WPZ003-01	167	NM-B103-100-01	372	NM-G60710-10N	403
MP-054450-80	83	MR-WPZ006-01	179	NM-B103-100-06	372	NM-G60710-20N	403
MP-054500-10	83	MR-WPZ023-01	182	NM-B103-120-01	372	NM-G60710-80N	403
MP-054500-80	83	MR-ZSL011-01	140	NM-B103-120-06	372	NM-G60820-01N	403
MP-086350-10	83			NM-B104-100-01	379	NM-G60820-05N	403
MP-086350-80	83			NM-B104-150-01	379	NM-G60820-06N	403
MP-086450-10	83			NM-B104-200-01	379	NM-G60820-20N	403
MP-086450-80	83			NM-BAHIA40-150-01	378	NM-G61100-01	403
MP-118350-10	83			NM-BD-001-M1B	383	NM-G61100-20N	403
MP-118400-10	83			NM-BD-003-01	373	NM-KL-DPA-20	396
MP-118450-10	83			NM-BD-003-02	373	NM-KL-DPL-20	395

NM-MDN926-01	389	NM-X-LINE40710-10	406	PA-GLAXDR-AL	479	PA-GLAXWPKT-AL	473
NM-MDN927-01	390	NM-X-LINE40710-20	406	PA-GLAXGKL3M-00	459	PA-OSMLGLAX-00	467, 470, 472, 473, 474, 475,
NM-MDN941-01	390	NM-X-LINE40820-20	406	PA-GLAXGKS3M-00	460		476, 477, 479
NM-MDN-D4-01	388	NM-X-LINE40870-20	406	PA-GLAXGKW3M-00	461		
NM-MLA-50-75	397	NM-X-LINE401100-20	406	PA-GLAXGKWK3M-00	462	PA-OSMLGLAX3M-00	467, 470, 472, 474, 480, 481, 482,
NM-MLA-65-85	398			PA-GLAXGKZK3M-00	464		483
NM-MLA-85-125	398	O		PA-GLAXKT3M-AL	472	PA-OSMLGLAXM-00	466, 468, 471, 478
NM-MLA-95-145	399	OC-2PV340-01	239	PA-GLAXKT-AL	472	PA-OSMLGLAXM3M-00	459, 460, 461, 462, 464, 466,
NM-MLA-125-195	399	OC-2PV340-01-18	239	PA-GLAXMIC3M-AL	469		484, 485
NM-MLA-KL	400	OC-2PV350-01	239	PA-GLAXMIC-AL	469	PA-OSMLGLAXMIC-00	465, 469
NM-MUFAWB-00	394	OC-2PV350-01-18	239	PA-GLAXMICNK3M-AL	465	PA-OSMLGLAXMIC3M-00	465, 469
NM-MUFAWK-00	394	OC-2PV360-01	239	PA-GLAXMICNK-AL	465	PA-OSMLGLAXMK-00	466, 471
NM-NACK27651-06	382	OC-2PV360-01-18	239	PA-GLAXMNBW3M19-AL	485	PA-OSMLGLAXMK3M-00	459, 460, 461, 462, 464, 466,
NM-S60710-01A	404	OC-2PV370-01	239	PA-GLAXMNBW3M-AL	485		469
NM-S60710-02A	404	OC-2PV370-01-18	239	PA-GLAXMNBW3M19-AL	484	PA-OSMLGLAXM3M-00	459, 460, 461, 462, 464, 466,
NM-S60710-05A	404	OC-2PV380-01	239	PA-GLAXMNBW3M-AL	484		469
NM-S60710-10A	404	OC-2PV380-01-18	239	PA-GLAXMNBW3M19-AL	484	PA-OSMLGLAXMK3M-00	459, 460, 461, 462, 464, 466,
NM-S60710-20A	404	OC-2PV390-01	239	PA-GLAXMNBW3M-AL	484		469
NM-S60820-01A	404	OC-2PV390-01-18	239	PA-GLAXMNBW3M19-AL	484	PA-OSMLGLAXM3M-00	459, 460, 461, 462, 464, 466,
NM-S60820-02A	404	OC-A0150-06	238	PA-GLAXMNBW3M-AL	484		469
NM-S60820-05A	404	OC-A0160-06	238	PA-GLAXMNBW3M19-AL	484	PA-OSMLGLAXM3M-00	459, 460, 461, 462, 464, 466,
NM-SQ40ADJ-060	379	OC-A0170-06	238	PA-GLAXMNBW3M-AL	466		475
NM-SQ40ADJ-060-05	379	OC-A0180-06	238	PA-GLAXMNBW3M19-AL	466	PA-OSMLGLAXT-00	474
NM-SQ40ADJ-080	379	OC-A0190-06	238	PA-GLAXMNBW3M-AL	466	PA-OSMLGLAXT3M-00	459, 460, 461, 462, 464, 466,
NM-SQ40ADJ-080-05	379	OC-A0350K-06	240	PA-GLAXMNBW3M19-AL	466		475, 476,
NM-SQ40ADJ-100	379	OC-A0450-06	240	PA-GLAXMNBW3M-AL	466	PA-OSTRGLAX-00	467, 470, 472, 473, 474, 475, 476,
NM-SQA100-01	380	OC-A0460D-06	241	PA-GLAXMNBW3M19-AL	468		477, 479
NM-SQA150-01	380	OC-A0660-06	238	PA-GLAXMNBW3M-AL	478	PA-OSTRGLAX3M-00	467, 470, 472, 473, 474, 475, 476,
NM-STGC50-95-01	384	OC-A0680-06	238	PA-GLAXMPK-AL	478		477, 479
NM-STGY135-100-01	384	OC-E0707D-CZ	241	PA-GLAXMW-AL	471	PA-OSTRGLAX3M-00	467, 470, 472, 473, 474, 475, 476,
NM-STGY135-120-01	385	OM-OBK150-20B	262	PA-GLAXMW-AL-10	471		472, 474, 480,
NM-STGY135-130-01	384	OM-OBK175-20	262	PA-GLAXMW-AL-20M	471	PA-OSTRGLAXM-00	466, 468, 471, 478
NM-STGY135-150-01	384	OM-OBO300-05	262	PA-GLAXMW-AL-90	471		475, 476,
NM-STOMP-100-01	385	OM-OBO350-05	262	PA-GLAXNB3M16-AL	482	PA-OSTRGLAXM3M-00	466, 484, 485
NM-STOMP-120-01	386	OM-OBO400-05	262	PA-GLAXNB3M-AL	482		479
NM-STOMP-120-10	385			PA-GLAXNB3M16-AL	483	PA-ROZGLAX-53	479
NM-STOMP-120-20	385	P		PA-GLAXNBW3M19-AL	483	PA-ROZGLAXP-53	479
NM-STOMP-130-01	385	PA-0241-35-50	318	PA-GLAXNBW3M19-AL	483	PA-SPRGLAXM-00	466, 468, 475
NM-STOMP-130-06	385	PA-0242-35-50	316	PA-GLAXNBW3M-AL	480		465, 474
NM-STOMP-130-20	385	PA-0242-35-50-06	316	PA-GLAXNB3M19-AL	480	PA-SPRGLAXMIC-00	465, 474
NM-STOMP-150-01	385	PA-0242-35-50-20M	316	PA-GLAXNB3M-AL	480	PA-USZGLAX-00N	477
NM-STOMP-160-01	385	PA-0243-35-50	317	PA-GLAXNB3M19-AL	480	PA-USZGLAX-10N	477
NM-STOMP-160-06	385	PA-0243-35-50-06	317	PA-GLAXNB3M16-AL	481	PA-ZASGLAX-00	470
NM-STOMP-160-20	385	PA-0243-35-50-06	317	PA-GLAXNB3M19-AL	481	PA-ZASGLAX-10	470
NM-STOPKA-M6	393	PA-0243-35-50-20M	317	PA-GLAXNB3M-AL	481	PA-ZASGLAX-20M	470
NM-STOPKSESTK-M6	394	PA-0244-35-50	317	PA-GLAXNB3M16-AL	467	PA-ZASGLAX-90	470
NM-STPL-135-01	386	PA-0245-35-50	318	PA-GLAXNB3M-AL	467	PA-ZASGLAXDR-00	479
NM-STR50-100-01	374	PA-CPGLAXAH-00	459, 460, 461, 462, 464	PA-GLAXNKT3M-AL	474	PA-ZASGLAXKT-00	472
NM-STR50-120-01	374			PA-GLAXNKT-AL	474	PA-ZASGLAXMIC-00	469
NM-STR50-150-01	374	PA-CPGLAXAV-00	459, 460, 461, 462, 464	PA-GLAXNKT-AL-10	474	PA-ZASGLAXMICNK-00	465
NM-STR60-80-01	375			PA-GLAXNKT-AL-20M	474	PA-ZASGLAXMNK-00	466
NM-STSL-170-60-01	391	PA-CPGLAXL-00	459, 460, 461, 462, 464	PA-GLAXNKT-AL-90	474	PA-ZASGLAXMNK-20M	466
NM-TOKYO40-150-01	382	PA-GLAX3M-AL	470	PA-GLAXRAD-AL	475	PA-ZASGLAXMNK-90	466
NM-WPJ22-D20	392	PA-GLAX-AL	470	PA-GLAXREG1-AL	476	PA-ZASGLAXMNK-00	466
NM-XH3065-05	388	PA-GLAX-AL-10	470	PA-GLAXREG2-AL	476	PA-ZASGLAXMNK-00	466
NM-XH8273-01	389	PA-GLAX-AL-20M	470	PA-GLAXWN16-AL	477	PA-ZASGLAXMNK-00	466
NM-X-LINE40710-01	406	PA-GLAX-AL-90	470	PA-GLAXWN19-AL	477	PA-ZASGLAXMNKW-00	468
				PA-GLAXWN-AL	477	PA-ZASGLAXMNKW-10	468

PA-ZASGLAXMNKW-20M	468	PB-45-MF202X10-60A	221	PB-AXISPRO-KPL550C	90	PB-D-D2R0-01	104, 121
PA-ZASGLAXMNKW-90	468	PB-45-MF342X17-60A	227	PB-AXISPRO-KPL550C1	90	PB-D-KPL68-450-10	123
PA-ZASGLAXMW-00	471	PB-90114100	229	PB-AXISPRO-KPL550D	90	PB-D-KPL68-450-80	123
PA-ZASGLAXMW-10	471	PB-90144100PCT	230	PB-AXISPRO-KPL550D1	90	PB-D-KPL68-500-10	123
PA-ZASGLAXMW-20M	471	PB-90934100PCT	231	PB-AXISPRO-PANELWEW-95R		PB-D-KPL68-500-80	123
PA-ZASGLAXMW-90	471	PB-91014100	228		93	PB-D-KPL250A	109
PA-ZASGLAXMWK-00	471	PB-91024160V	228	PB-AXISPRO-PANELWEW-95R-10		PB-D-KPL250A1	109
PA-ZASGLAXNK-00	467	PB-91104100B5	232		93	PB-D-KPL250C	110
PA-ZASGLAXNKKT-00	474	PB-91114100B5	232	PB-AXISPRO-PANELWEW-110		PB-D-KPL250C1	110
PA-ZASGLAXNKKT-10	474	PB-91164100B5	232		93	PB-D-KPL300A	109
PA-ZASGLAXNKKT-20M	474	PB-91174100B5	232	PB-AXISPRO-PANELWEW-110-10		PB-D-KPL300A1	109
PA-ZASGLAXNKKT-90	474	PB-91634100B5V	232		93	PB-D-KPL300B	110
PA-ZASGLAXNKKT-00	474	PB-91644100B5V	232	PB-AXISPRO-PANELWEW-110R		PB-D-KPL300C	110
PA-ZASGLAXRAD-00	475	PB-AXISPRO-KPL300A	89		94	PB-D-KPL300C1	110
PA-ZAWGLAXDR-00	475, 479	PB-AXISPRO-KPL300A1	89	PB-AXISPRO-PANELWEW-110R-10		PB-D-KPL350A	109
PB-0FPO-250	62	PB-AXISPRO-KPL300B	89		94	PB-D-KPL350A1	109
PB-0FPO-270	62	PB-AXISPRO-KPL300B1	89	PB-AXISPRO-RELKW300	95	PB-D-KPL350B	110
PB-0FPO-300	62	PB-AXISPRO-KPL300C	90	PB-AXISPRO-RELKW300-1095		PB-D-KPL350C	110
PB-0FPO-350	62	PB-AXISPRO-KPL300C1	90	PB-AXISPRO-RELKW350	95	PB-D-KPL350C1	110
PB-0FPO-400	62	PB-AXISPRO-KPL300D	90	PB-AXISPRO-RELKW350-1095		PB-D-KPL400A	109
PB-0FPO-450	62	PB-AXISPRO-KPL300D1	90	PB-AXISPRO-RELKW400	95	PB-D-KPL400A1	109
PB-0FPO-500	62	PB-AXISPRO-KPL350A	89	PB-AXISPRO-RELKW400-1095		PB-D-KPL400B	110
PB-0FPO-550	62	PB-AXISPRO-KPL350A1	89	PB-AXISPRO-RELKW450	95	PB-D-KPL400C	110
PB-0FPO-600	62	PB-AXISPRO-KPL350B	89	PB-AXISPRO-RELKW450-1095		PB-D-KPL400C1	110
PB-0SHX18-300-H	57	PB-AXISPRO-KPL350B1	89	PB-AXISPRO-RELKW500	95	PB-D-KPL450A	109
PB-0SHX18-350-H	57	PB-AXISPRO-KPL350C	90	PB-AXISPRO-RELKW500-1095		PB-D-KPL450A1	109
PB-0SHX18-400-H	57	PB-AXISPRO-KPL350C1	90	PB-AXISPRO-RELKW550	95	PB-D-KPL450B	110
PB-0SHX18-450-H	57	PB-AXISPRO-KPL350D	90	PB-AXISPRO-RELKW550-1095		PB-D-KPL450C	110
PB-0SHX18-500-H	57	PB-AXISPRO-KPL350D1	90	PB-AXISPRO-WEWMOCA	91	PB-D-KPL450C1	110
PB-0SHX18-550-H	57	PB-AXISPRO-KPL400A	89	PB-AXISPRO-WEWMOCA1	91	PB-D-KPL500A	109
PB-0SHX-250-A	56	PB-AXISPRO-KPL400A1	89	PB-AXISPRO-WEWMOCB	91	PB-D-KPL500A1	109
PB-0SHX-270-A	56	PB-AXISPRO-KPL400B	89	PB-AXISPRO-WEWMOCB1	91	PB-D-KPL500B	110
PB-0SHX-300-A	56	PB-AXISPRO-KPL400B1	89	PB-AXISPRO-WEWMOCC	92	PB-D-KPL500C	110
PB-0SHX-350-A	56	PB-AXISPRO-KPL400C	90	PB-AXISPRO-WEWMOCC1	92	PB-D-KPL500C1	110
PB-0SHX-400-A	56	PB-AXISPRO-KPL400C1	90	PB-AXISPRO-WEWMOCD	92	PB-D-KPL550A	109
PB-0SHX-450-A	56	PB-AXISPRO-KPL400D	90	PB-AXISPRO-WEWMOCD1	92	PB-D-KPL550A1	109
PB-0SHX-500-A	56	PB-AXISPRO-KPL400D1	90	PB-D-BXSIDE45B	118	PB-D-KPL550B	110
PB-0SHX-550-A	56	PB-AXISPRO-KPL450A	89	PB-D-BXSIDE45B-10	118	PB-D-KPL550C	110
PB-0SHX-600-A	56	PB-AXISPRO-KPL450A1	89	PB-D-BXSIDE45C	119	PB-D-KPL550C1	110
PB-3D0SHX18-300-H	58	PB-AXISPRO-KPL450B	89	PB-D-BXSIDE45C-10	119	PB-D-LIS1100	116
PB-3D0SHX18-350-H	58	PB-AXISPRO-KPL450B1	89	PB-D-BXSIDE50B	118	PB-D-LIS1100-10	116
PB-3D0SHX18-400-H	58	PB-AXISPRO-KPL450C	90	PB-D-BXSIDE50B-10	118	PB-D-LIS1100-KW	102
PB-3D0SHX18-450-H	58	PB-AXISPRO-KPL450C1	90	PB-D-BXSIDE50C	119	PB-D-LIS1100-KW-10	102
PB-3D0SHX18-500-H	58	PB-AXISPRO-KPL450D	90	PB-D-BXSIDE50C-10	119	PB-D-LR-00-0	115
PB-3D0SHX18-550-H	58	PB-AXISPRO-KPL450D1	90	PB-D-BXSIDEKW45C	103	PB-D-LR-00-10	115
PB-45-002X15-60A	220	PB-AXISPRO-KPL500A	89	PB-D-BXSIDEKW45C-10	103	PB-D-MATRYCA	106, 121
PB-45-002X20-60A	222	PB-AXISPRO-KPL500A1	89	PB-D-BXSIDEKW45C-60	103	PB-D-MBSTAB-00	123
PB-45-0010X3-60A	219	PB-AXISPRO-KPL500B	89	PB-D-BXSIDEKW50C	103	PB-D-MHG04	122
PB-45-202X10-60A	220, 224	PB-AXISPRO-KPL500B1	89	PB-D-BXSIDEKW50C-10	103	PB-D-MHG04-KW	106
PB-45-400MF-2X16-60A	218	PB-AXISPRO-KPL500C	90	PB-D-BXSIDEKW50C-60	103	PB-D-N2R0-00	104, 119
PB-45-450-2X20-60A	224	PB-AXISPRO-KPL500C1	90	PB-D-CONBXSID	117	PB-D-N2R0-01	104, 119
PB-45-450MF202X10-60A	225	PB-AXISPRO-KPL500D	90	PB-D-CONBXSIDE-10	117	PB-D-P20250A	109
PB-45-600MF-2X27-60A	226	PB-AXISPRO-KPL500D1	90	PB-D-CONREL	117	PB-D-P20300A	109
PB-45-002010-60A	219	PB-AXISPRO-KPL550A	89	PB-D-CONREL-10	117	PB-D-P20300C	110
PB-45-MF2X15-60A	223	PB-AXISPRO-KPL550A1	89	PB-D-CONREL-KW	102	PB-D-P20350A	109
PB-45-MF002X20-60A221,	225	PB-AXISPRO-KPL550B	89	PB-D-CONREL-KW-10	102	PB-D-P20350C	110
PB-45-MF2X34-60A	227	PB-AXISPRO-KPL550B1	89	PB-D-D2R0-00	104, 121	PB-D-P20400A	109

PB-D-P20400C	110	PB-D-WEWSZKLC-10	112	PB-KW-KPL350C2	98	PD-GAM060-N02	47
PB-D-P20450A	109	PB-D-ZLE-450	124	PB-KW-KPL400A	97	PD-GAM060-N10	47
PB-D-P20450C	110	PB-D-ZLE-500	124	PB-KW-KPL400A1	97	PD-GAM060-N60	47
PB-D-P20500A	109	PB-D-ZNACZ-0	107, 122	PB-KW-KPL400A2	97	PD-GAM080-N02	47
PB-D-P20500C	110	PB-D-ZR-00-0	114	PB-KW-KPL400B	97	PD-GAM080-N10	47
PB-D-P20550C	110	PB-D-ZR-00-10	114	PB-KW-KPL400B1	97	PD-GAM080-N60	47
PB-D-P20STAB	87	PB-D-ZR-KW-00	101	PB-KW-KPL400B2	97	PD-GAM100-N02	47
PB-D-PANELWEW	100, 113	PB-D-ZR-KW-10	101	PB-KW-KPL400C	98	PD-GAM100-N10	47
PB-D-PANELWEW-10100,	113	PB-G10HX-350	64	PB-KW-KPL400C1	98	PD-GAM100-N60	47
PB-D-PRZEGLP	118	PB-G10HX-450	64	PB-KW-KPL400C2	98	PD-GAM120-N02	47
PB-D-PRZEGLP-10	118	PB-G10HX-500	64	PB-KW-KPL450A	97	PD-GAM120-N10	47
PB-D-PRZEGLP-KW	103	PB-G10HX-550	64	PB-KW-KPL450A1	97	PD-GAM120-N60	47
PB-D-PRZEGLP-KW-10	103	PB-GAPO-300	61	PB-KW-KPL450A2	97	PD-GAM150-N02	47
PB-D-REL450-10	111	PB-GAPO-350	61	PB-KW-KPL450B	97	PD-GAM150-N10	47
PB-D-REL500-10	111	PB-GAPO-400	61	PB-KW-KPL450B1	97	PD-GAM150-N60	47
PB-D-REL550-10	111	PB-GAPO-450	61	PB-KW-KPL450B2	97	PD-GAMB050-N02	48
PB-D-REL2500	111	PB-GAPO-500	61	PB-KW-KPL450C	98	PD-GAMB050-N10	48
PB-D-REL3000	111	PB-GAPO-550	61	PB-KW-KPL450C1	98	PD-GAMB050-N60	48
PB-D-REL3500	111	PB-GCHX-250	59	PB-KW-KPL450C2	98	PD-GAMB060-N02	48
PB-D-REL4000	111	PB-GCHX-270	59	PB-KW-KPL500A	97	PD-GAMB060-N10	48
PB-D-REL4500	111	PB-GCHX-300	59	PB-KW-KPL500A1	97	PD-GAMB060-N60	48
PB-D-REL5000	111	PB-GCHX-300-H	60	PB-KW-KPL500A2	97	PD-GAMB080-N02	48
PB-D-REL5500	111	PB-GCHX-350	59	PB-KW-KPL500B	97	PD-GAMB080-N10	48
PB-D-RELCOV	116	PB-GCHX-350-H	60	PB-KW-KPL500B1	97	PD-GAMB080-N60	48
PB-D-RELCOV-10	116	PB-GCHX-400	59	PB-KW-KPL500B2	97	PD-GAMB100-N02	48
PB-D-RELKW350	98	PB-GCHX-400-H	60	PB-KW-KPL500C	98	PD-GAMB100-N10	48
PB-D-RELKW350-10	98	PB-GCHX-450	59	PB-KW-KPL500C1	98	PD-GAMB100-N60	48
PB-D-RELKW400	98	PB-GCHX-450-H	60	PB-KW-KPL500C2	98	PD-GAMB120-N02	48
PB-D-RELKW400-10	98	PB-GCHX-500	59	PB-KW-KPL550A	97	PD-GAMB120-N10	48
PB-D-RELKW450	98	PB-GCHX-500-H	60	PB-KW-KPL550A1	97	PD-GAMB120-N60	48
PB-D-RELKW450-10	98	PB-GCHX-550	59	PB-KW-KPL550A2	97	PD-GAMB150-N02	48
PB-D-RELKW500	98	PB-GCHX-550-H	60	PB-KW-KPL550B	97	PD-GAMB150-N10	48
PB-D-RELKW500-10	98	PB-GCHX-600	59	PB-KW-KPL550B1	97	PD-GAMB150-N60	48
PB-D-RELKW550	98	PB-KW-KPL250A1	97	PB-KW-KPL550B2	97	PD-GPD01-001	51
PB-D-RELKW550-10	98	PB-KW-KPL250A2	97	PB-KW-KPL550C	98	PD-GPD02-002	51
PB-D-RP-1100	114	PB-KW-KPL250B	97	PB-KW-KPL550C1	98	PD-GPD03-005	51
PB-D-RP-1100-10	114	PB-KW-KPL250B1	97	PB-KW-KPL550C2	98	PD-LIFT-HEAVY_DUTY-10	46
PB-D-S2R0-00	105, 120	PB-KW-KPL250B2	97	PB-RP-KW1100	101	PD-LIFT-HEAVY_DUTY-80	46
PB-D-S2R0-01	105, 120	PB-KW-KPL250C	98	PB-RP-KW1100-10	101	PD-LIFT-LIGHT-10	46
PB-D-UCHWEW	115	PB-KW-KPL250C1	98	PB-S10C300HX	63	PD-LIFT-LIGHT-80	46
PB-D-UCHWEW-10	115	PB-KW-KPL250C2	98	PB-S10C350HX	63	PD-LIFT-MEDIUM-10	46
PB-D-ULE-500	124	PB-KW-KPL300A	97	PB-S10C400HX	63	PD-LIFT-MEDIUM-80	46
PB-D-W2R0-00	105, 120	PB-KW-KPL300A1	97	PB-S10C450HX	63	PD-LIFT-STRONG-10	46
PB-D-W2R0-01	105, 120	PB-KW-KPL300A2	97	PD-ECGDL-060	55	PD-LIFT-STRONG-80	46
PB-D-WEWMOCA	111	PB-KW-KPL300B1	97	PD-ECGDL-080	55	PD-MDLIFT-P1-D	53
PB-D-WEWMOCA1	111	PB-KW-KPL300B2	97	PD-ECGDL-150	55	PD-MDLIFT-P2-D	54
PB-D-WEWMOCA-KW	99	PB-KW-KPL300C	98	PD-G0050-N02	49	PD-MD-ZB-01-KPL	39
PB-D-WEWMOCA-KW-10	99	PB-KW-KPL300C1	98	PD-G0060-N02	49	PD-MD-ZB-04-KPL	39
PB-D-WEWMOCB	112	PB-KW-KPL300C2	98	PD-G0080-N02	49	PD-PD000-001	52
PB-D-WEWMOCB1	112	PB-KW-KPL350A	97	PD-G0100-N02	49	PG-AL4560-20	217
PB-D-WEWMOCB-KW	99	PB-KW-KPL350A1	97	PD-G0120-N02	49	PG-AL6083-20	217
PB-D-WEWMOCB-KW-10	99	PB-KW-KPL350A2	97	PD-G0150-N02	49	PG-AL8311520	217
PB-D-WEWMOCC	113	PB-KW-KPL350B	97	PD-G60160-02	50	PG-GA4560-10	216
PB-D-WEWMOCC1	113	PB-KW-KPL350B1	97	PD-G80160-02	50	PG-GA4560-20	216
PB-D-WEWMOCC-KW	100	PB-KW-KPL350B2	97	PD-GAM050-N02	47	PG-GA6083-10	216
PB-D-WEWMOCC-KW-10	100	PB-KW-KPL350C	98	PD-GAM050-N10	47	PG-GA6083-20	216
PB-D-WEWSZKLC	112	PB-KW-KPL350C1	98	PD-GAM050-N60	47	PG-GA8311520	216

PG-ST4560-10	217	PK-0H17406XP	81	PK-S-H45-700	71	PM-PLF160-58	250
PG-ST4560-10A	193	PK-0H17438XP	81	PM-LBF160-01	251	PP-00GS01-01	128
PG-ST4560-20	217	PK-0H45250GX1	75	PM-LBF160-02	251	PP-00GS01-02	128
PG-ST4560-60	193	PK-0H45300GX1	75	PM-LBF160-05	251	PP-00GS02-01	128
PG-ST6083-10	217	PK-0H45350GX1	75	PM-LBF160-06	251	PP-00GS02-02	128
PG-ST6083-10A	193	PK-0H45400GX1	75	PM-LBF180-01	251	PP-00GS02-05	128
PG-ST6083-20	217	PK-0H45450GX1	75	PM-LBF180-02	251	PP-00GS02-06	128
PG-ST6083-60	193	PK-0H45500GX1	75	PM-LBF180-05	251	PP-00GS03-01	129
PG-ST83115-10	217	PK-0H45550GX1	75	PM-LBF180-06	251	PP-00GS03-02	129
PG-ST83115-10A	193	PK-0H45600GX1	75	PM-NAR1003-512	148	PP-00GS03-05	129
PG-ST83115-60	193	PK-0H45650GX1	75	PM-NAR1003-645	148	PP-00GS03-06	129
PG-ST8311520	217	PK-0H45700GX1	75	PM-NAR1003-677	148	PP-00GS04-01	129
PK-0-000-027	80	PK-L-H35-300	76	PM-NAR1003-680	148	PP-00GS04-02	129
PK-0H27-3000	79	PK-L-H35-350	76	PM-NAR1003-695	148	PP-00GS04-05	129
PK-0H27-3500	79	PK-L-H35-400	76	PM-NAR1003-725	148	PP-00GS04-06	129
PK-0H27-4000	79	PK-L-H35-450	76	PM-NAR1003-728	148	PP-20BUW0-05	201
PK-0H27-4500	79	PK-L-H35-500	76	PM-NAR1003-731	148	PP-BAR-20M	370
PK-0H27-5000	79	PK-L-H35-550	76	PM-NAR1003-732	148	PP-BELT-20M	365
PK-0H30-2500	78	PK-L-H45-250	68	PM-NAR1003-770	148	PP-DPO105-06	127
PK-0H30-3000	78	PK-L-H45-250-A	69	PM-NAR1003-771	148	PP-DPO105-01	127
PK-0H30-3500	78	PK-L-H45-300	68	PM-NAR1004-512	149	PP-DPO105-02	127
PK-0H30-4000	78	PK-L-H45-300-A	69	PM-NAR1004-645	149	PP-DPO105-05	127
PK-0H35-2500	77	PK-L-H45-300-GX	70	PM-NAR1004-677	149	PP-FLAT-20M	365
PK-0H35-3000	77	PK-L-H45-350	68	PM-NAR1004-680	149	PP-GALA-20M	366
PK-0H35-3500	77	PK-L-H45-350-A	69	PM-NAR1004-695	149	PP-GINO-20M	366
PK-0H35-4000	77	PK-L-H45-350-GX	70	PM-NAR1004-724	149	PP-GL-A48-01	130
PK-0H35-4500	77	PK-L-H45-400	68	PM-NAR1004-725	149	PP-GL-B48-01	130
PK-0H35-5000	77	PK-L-H45-400-A	69	PM-NAR1004-728	149	PP-GL-CGP-01	131
PK-0-H45-250	74	PK-L-H45-400-GX	70	PM-NAR1004-732	149	PP-GL-DR5-01	139
PK-0-H45-300	74	PK-L-H45-450	68	PM-NAR1004-770	149	PP-GL-E410-01	131
PK-0-H45-350	74	PK-L-H45-450-A	69	PM-NAR1004-771	149	PP-HS0006-01	133
PK-0-H45-400	74	PK-L-H45-450-GX	70	PM-PFMH50-24	159	PP-HS2710-01	134
PK-0-H45-450	74	PK-L-H45-500	68	PM-PFMH50-25	159	PP-INGRID-20M	368
PK-0-H45-500	74	PK-L-H45-500-A	69	PM-PFMH51-10	159	PP-LUK-00-01	142
PK-0-H45-550	74	PK-L-H45-500-GX	70	PM-PFMH53-10	159	PP-LUK-00-02	142
PK-0-H45-600	74	PK-L-H45-550	68	PM-PFMH55-25	159	PP-LUK-00-05	142
PK-0-H45-700	74	PK-L-H45-550-A	69	PM-PFMH61-10	159	PP-MP0055-01	126
PK-0-H53-300	66	PK-L-H45-550-GX	70	PM-PFMH64-10	159	PP-MP0055-02	126
PK-0-H53-350	66	PK-L-H45-600	68	PM-PFMH64-25	159	PP-MP0055-05	126
PK-0-H53-400	66	PK-L-H45-600-A	69	PM-PFMH69-10	159	PP-MP0055-06	126
PK-0-H53-450	66	PK-L-H45-600-GX	70	PM-PLF160-02	250	PP-MP0055-10	126
PK-0-H53-500	66	PK-P-H45-300-GX	73	PM-PLF160-05	250	PP-MP0055-20	126
PK-0-H53-550	66	PK-P-H45-350-GX	73	PM-PLF160-10	250	PP-NEO-20M	368
PK-0-H53-600	66	PK-P-H45-400-GX	73	PM-PLF160-20	250	PP-NW09X90B	141
PK-0-H53-650	66	PK-P-H45-450-GX	73	PM-PLF160-30	250	PP-NW10X100B	141
PK-0-H53-700	66	PK-P-H45-500-GX	73	PM-PLF160-41	250	PP-NW10X145B	141
PK-0-H53-750	66	PK-P-H45-550-GX	73	PM-PLF160-42	250	PP-NW12X120B	141
PK-0-H53-800	66	PK-P-H45-600-GX	73	PM-PLF160-43	250	PP-NW14X120B	141
PK-0-H53-900	66	PK-S-H45-250	71	PM-PLF160-44	250	PP-NW14X140B	141
PK-0-H53-1000	66	PK-S-H45-300	71	PM-PLF160-45	250	PP-NW14X165B	141
PK-0-H53-1100	66	PK-S-H45-350	71	PM-PLF160-46	250	PP-OBUW60-05	202
PK-0H17182XP	81	PK-S-H45-400	71	PM-PLF160-47	250	PP-OBUW60-PW	202
PK-0H17214XP	81	PK-S-H45-450	71	PM-PLF160-48	250	PP-OBUW70-05	202
PK-0H17246XP	81	PK-S-H45-500	71	PM-PLF160-49	250	PP-OBUW70-PW	202
PK-0H17278XP	81	PK-S-H45-550	71	PM-PLF160-50	250	PP-OBUW80-05	202
PK-0H17310XP	81	PK-S-H45-600	71	PM-PLF160-51	250	PP-OBUW80-PW	202
PK-0H17342XP	81	PK-S-H45-650	71	PM-PLF160-52	250	PP-OBUW90-05	202

PP-OBUW90-PW	202	PR-SP-550-10	84	RS-368288-06	310	UA-00-313192	290
PP-P04570-20	215	PR-SP-600-10	84	RS-400320-01	310	UA-00-319096	291
PP-P80110-20	215	PU-KEY027-20	245	RS-400320-02	310	UA-00-319128	291
PP-PMONT0D-01	148	PU-KEY027-60	245	RS-400320-05	310	UA-00-319160	291
PP-PMONT0D-07	148	PU-KEYM27-20	246	RS-400320-06	310	UA-00-326096-20M	312
PP-PMONT0D-08	148	PU-KEYM27-60	246	RS-400320-14	310	UA-00-326128-20M	312
PP-PMONT0D-11	148	PU-PKO-00-20	246	RS-432352-01	310	UA-00-326160-20M	312
PP-PMONT0D-20	148	PU-PKO-00-60	246	RS-432352-02	310	UA-00-337096	299
PP-PMONT0D-22	148	PW-PC31209-00N	486	RS-432352-05	310	UA-00-337096-20M	299
PP-PMONT0D-41	148	PW-PC61209-00	486	RS-432352-06	310	UA-00-337128	299
PP-PMONT0D-50	148			RS-464384-01	310	UA-00-337128-20M	299
PP-PMONT0D-724	148	R		RS-464384-02	310	UA-00-337160	299
PP-PMONT0D-732	148	RR-161030H01	165	RS-464384-05	310	UA-00-337160-20M	299
PP-PMONT0M-01	147	RR-161230H01	165	RS-464384-06	310	UA-00-337192	299
PP-PMONT0M-07	147	RR-250730H01	165	RS-496416-01	310	UA-00-337192-20M	299
PP-PMONT0M-08	147	RR-250830H01	165	RS-496416-02	310	UA-00-337224	299
PP-PMONT0M-11	147	RR-250930H01	165	RS-496416-05	310	UA-00-337224-20M	299
PP-PMONT0M-22	147	RR-250930H10	191	RS-496416-06	310	UA-00-337256	299
PP-ROD-20M	370	RR-250930H60	191	RS-528448-01	310	UA-00-337256-20M	299
PP-S0L003-01T	132	RR-251030H01	165	RS-528448-02	310	UA-00-337320	299
PP-S0L012-01T	133	RR-401230H01	165	RS-528448-05	310	UA-00-337320-20M	299
PP-SMART-000	141	RR-501030H01	165	RS-528448-06	310	UA-00-338128	299
PP-SP0075-01	127	RR-501230H01	165	RS-560480-01	310	UA-00-338160	299
PP-SP0075-02	127	RR-CH-OW-000	163	RS-560480-02	310	UA-00-340128	300
PP-SP0075-05	127	RS-156096-01	310	RS-560480-05	310	UA-00-340160	300
PP-SP0075-06	127	RS-156096-02	310	RS-560480-06	310	UA-00-340192	300
PP-SPL001-01	140	RS-156096-05	310	RS-592512-01	310	UA-00-340224	300
PP-TREE-20M	371	RS-156096-06	310	RS-592512-02	310	UA-00-340256	300
PP-WIRE-20M	371	RS-156096-14	310	RS-592512-05	310	UA-00-340320	300
PP-XS0045-01	126	RS-188128-01	310	RS-592512-06	310	UA-00-347128	300
PP-XS0045-05	126	RS-188128-02	310	RS-624544-01	310	UA-00-347160	300
PR-OB-250-10	85	RS-188128-05	310	RS-624544-02	310	UA-00-347192	300
PR-OB-250-30	85	RS-188128-06	310	RS-624544-05	310	UA-00-347224	300
PR-OB-300-10	85	RS-188128-14	310	RS-624544-06	310	UA-00-347256	300
PR-OB-300-30	85	RS-220160-01	310	RS-SZ-400-10	86	UA-00-347320	300
PR-OB-350-10	85	RS-220160-02	310	RS-SZ-450-10	86	UA-01-326096-V1	312
PR-OB-350-18	85	RS-220160-05	310	RS-SZ-500-10	86	UA-01-326128-V1	312
PR-OB-350-30	85	RS-220160-06	310	RS-TRIES-96-06	309	UA-01-326160	312
PR-OB-400-10	85	RS-220160-14	310	RS-TRIES-128-06	309	UA-18-128146	290
PR-OB-400-18	85	RS-272192-01	310	RS-TRIES-160-06	309	UA-18-160178	290
PR-OB-400-30	85	RS-272192-02	310	RS-TRIES-192-06	309	UA-18-192210	290
PR-OB-450-10	85	RS-272192-05	310	RS-TRIES-256-06	309	UA-18-224242	290
PR-OB-450-18	85	RS-272192-06	310	RS-TRIES-320-06	309	UA-18-256274	290
PR-OB-450-30	85	RS-272192-14	310			UA-18-320338	290
PR-OB-500-10	85	RS-304224-01	310	S		UA-18-400418	290
PR-OB-500-18	85	RS-304224-02	310	SB-A60X72-80	409	UA-18-416434	290
PR-OB-500-30	85	RS-304224-05	310	SZ-005-00-01-A	154	UA-18-480498	290
PR-OB-550-10	85	RS-304224-06	310	SZ-005-00-01T	154	UA-A3-096128	288
PR-OB-550-18	85	RS-304224-14	310	SZ-008-00-01-A	154	UA-A3-128160	288
PR-OB-600-10	85	RS-336256-01	310	SZ-008-00-01T	154	UA-A3-160192	288
PR-OB-600-18	85	RS-336256-02	310			UA-A3-192224	288
PR-SP-250-10	84	RS-336256-05	310	T		UA-A3-256288	288
PR-SP-300-10	84	RS-336256-06	310	TE-600000-30	509	UA-A3-320352	288
PR-SP-350-10	84	RS-336256-14	310			UA-A18128-01	290
PR-SP-400-10	84	RS-368288-01	310	U		UA-A18128-06MJ	290
PR-SP-450-10	84	RS-368288-02	310	UA-00-313128	290	UA-A18160-01	290
PR-SP-500-10	84	RS-368288-05	310	UA-00-313160	290	UA-A18160-06MJ	290

UA-A18192-01	290	UA-BETA-224-05	296	UA-PICADO-352-796-01	319	UP-WP0728-PA-07	321
UA-A18192-06MJ	290	UA-BETA-256-05	296	UA-PICADO-352-796-05	319	UP-WP0728-PB	321
UA-A18224-01	290	UA-BETA-288-05	296	UA-PICADO-352-796-20M	319	UP-WP0728-PC-04	321
UA-A18224-06MJ	290	UA-BETA-320-05	296	UA-PICCO-64-05	294	UP-WP0728-PK	321
UA-A18256-01	290	UA-DELTA-128-05	297	UA-PICCO-224-05	294	UP-WP0728-PR	321
UA-A18256-06MJ	290	UA-DELTA-160-05	297	UA-SIGMA-96-05	297	UP-WP0728-PX	321
UA-A18320-01	290	UA-DELTA-192-05	297	UA-SIGMA-128-05	297	UZ-00B224-01	313
UA-A18320-06MJ	290	UA-DELTA-224-05	297	UA-SIGMA-160-05	297	UZ-00B224-02	313
UA-A18400-01	290	UA-DELTA-256-05	297	UA-SIGMA-192-05	297	UZ-00B224-05	313
UA-A18400-06MJ	290	UA-DELTA-288-05	297	UA-SIGMA-224-05	297	UZ-00B224-10	313
UA-A18416-01	290	UA-DELTA-320-05	297	UA-SIGMA-256-05	297	UZ-00B224-20	313
UA-A18416-06MJ	290	UA-DOPPIO192-01	291	UA-SIGMA-288-05	297	UZ-00B226-01	313
UA-A18480-01	290	UA-DOPPIO416-01	291	UA-SIGMA-320-05	297	UZ-00B226-02	313
UA-A18480-06MJ	290	UA-GAMMA-96-05	296	UA-TREX-32-50-05	316	UZ-00B226-05	313
UA-AA-114-02	289	UA-GAMMA-192-05	296	UA-TREX-32-50-20M	316	UZ-00B226-10	313
UA-AA-114-05	289	UA-GAMMA-224-05	296	UA-TREX-96-150-05	316	UZ-00B226-20	313
UA-ARS096-20	270	UA-GAMMA-256-05	296	UA-TREX-96-150-20M	316	UZ-01-096-01	303
UA-ARS128-20	270	UA-GAMMA-288-05	296	UA-TREX-224-250-05	316	UZ-01-096-02	303
UA-ARS160-20	270	UA-GAMMA-320-05	296	UA-TREX-224-250-20M	316	UZ-01-096-05	303
UA-ARS192-20	270	UA-HEXI-01	315	UA-TREX-320-350-05	316	UZ-01-128-01	303
UA-ARS224-20	270	UA-HEXI-05	315	UA-TREX-320-350-20M	316	UZ-01-128-02	303
UA-ARS256-20	270	UA-HEXI-10M	315	UA-TREX-3500-05	316	UZ-01-128-05	303
UA-ARS320-20	270	UA-HEXI-20M	315	UM-BLOCK-CZ	344	UZ-02C064-01	339
UA-ARSG30-20	270	UA-HEXI96-01	315	UM-BLOCK-NB	344	UZ-02C096-01	339
UA-B0-311096	289	UA-HEXI96-05	315	UM-BLOCK-ZL	344	UZ-02CF27-01	339
UA-B0-311096-20M	289	UA-HEXI96-10M	315	UM-BUTTON-NB	344	UZ-05-096-01	303
UA-B0-311128	289	UA-HEXI96-20M	315	UM-BUTTON-SZ	344	UZ-05-096-02	303
UA-B0-311128-20M	289	UA-HEXI192-01	315	UM-CLOUD-NB	344	UZ-05-096-05	303
UA-B0-311160	289	UA-HEXI192-05	315	UM-CLOUD-SZ	344	UZ-05-128-01	303
UA-B0-311160-20M	289	UA-HEXI192-10M	315	UM-CROWN-RZ	344	UZ-05-128-02	303
UA-B0-311192	289	UA-HEXI192-20M	315	UM-FLAMING-RZ	344	UZ-05-128-05	303
UA-B0-311192-20M	289	UA-HEXI-3500-05	315	UM-FLAMING-SZ	344	UZ-06-128-01	304
UA-B0-311224	289	UA-KAPPA-96-05	298	UM-HEART-RZ	344	UZ-06-128-02	304
UA-B0-311224-20M	289	UA-KAPPA-128-05	298	UM-KID-C-001	346	UZ-06-128-05	304
UA-B0-311256	289	UA-KAPPA-160-05	298	UM-KID-D-001	346	UZ-07-096-01	304
UA-B0-311256-20M	289	UA-KAPPA-192-05	298	UM-KID-E-001	346	UZ-07-096-02	304
UA-B0-311288	289	UA-KAPPA-224-05	298	UM-KID-I-002	346	UZ-07-096-05	304
UA-B0-311320	289	UA-KAPPA-256-05	298	UM-KID-P-001	346	UZ-10-096-N04	323
UA-B0-311320-20M	289	UA-KAPPA-288-05	298	UM-KID-Q-001	346	UZ-12-096-04	323
UA-B0-311480	289	UA-KAPPA-320-05	298	UM-KID-S-001	346	UZ-12-096-04N	323
UA-B31109606MJ*	289	UA-PAXO-32-50-05	315	UM-KID-U-001	346	UZ-12-096-20M	323
UA-B31112801	289	UA-PAXO-96-150-05	315	UM-KID-W-001	347	UZ-13-096-01	305
UA-B31112806MJ*	289	UA-PAXO-224-250-05	315	UM-KID-X-001	347	UZ-13-096-02	305
UA-B31116001	289	UA-PAXO-320-350-05	315	UM-KID-Y-001	346	UZ-13-096-05	305
UA-B31116006MJ*	289	UA-PAXO-3500-05	315	UM-KID-Z-001	347	UZ-14-096-01	306
UA-B31119201	289	UA-PICADO-224-496-01	319	UM-STAR-NB	344	UZ-14-096-02	306
UA-B31119206MJ*	289	UA-PICADO-224-496-05	319	UM-STAR-RZ	344	UZ-14-096-05	306
UA-B31122401	289	UA-PICADO-224-496-20M	319	UM-STAR-ZT	344	UZ-14-128-01	306
UA-B31122406MJ*	289	UA-PICADO-256-296-01	319	UM-TWITT-SZ	344	UZ-14-128-02	306
UA-B31125601	289	UA-PICADO-256-296-05	319	UM-TWITT-ZL	344	UZ-14-128-05	306
UA-B31125606MJ*	289	UA-PICADO-256-296-20M	319	UM-UNICORN-RZ	347	UZ-40-032-01	276
UA-B31128806MJ*	289	UA-PICADO-256-596-01	319	UP-WP0728-BB	320	UZ-40-032-02	276
UA-B31132001	289	UA-PICADO-256-596-05	319	UP-WP0728-BK	320	UZ-40-032-05	276
UA-B31132006MJ	289	UA-PICADO-256-596-20M	319	UP-WP0728-BR	320	UZ-40-032-06	276
UA-B31148006MJ	289	UA-PICADO-320-396-01	319	UP-WP0728-BX	320	UZ-55-025-01	276
UA-BETA-96-05	296	UA-PICADO-320-396-05	319	UP-WP0728-P0	321	UZ-55-025-05	276
UA-BETA-192-05	296	UA-PICADO-320-396-20M	319	UP-WP0728-PA-04	321	UZ-60-032-01	277

UZ-60-032-02	277	UZ-819160-10	284	UZ-ANZIO-96-04	331	UZ-CAMAI-128-06	306
UZ-60-032-05	277	UZ-819160-12	284	UZ-APRIL-96-04	326	UZ-CAMAI-128-09	306
UZ-60-032-06	277	UZ-819160-14	284	UZ-ARCH096-AEB	327	UZ-CAMAI-128-10M	306
UZ-71C096-01	338	UZ-819160-15	284	UZ-ARDEA-96-09	324	UZ-CAMAI-128-12	306
UZ-133128-01	278	UZ-819160-20	284	UZ-AREZO-96-04	328	UZ-CAMAI-128-20M	306
UZ-133128-02	278	UZ-819192-01	284	UZ-ASTI096/128-01	269	UZ-CAPRI-96-01	283
UZ-133128-05	278	UZ-819192-02	284	UZ-ASTI192/224-01	269	UZ-CAPRI-96-02	283
UZ-133128-06	278	UZ-819192-05	284	UZ-ASTI288/320-01	269	UZ-CAPRI-96-05	283
UZ-334128-06	280	UZ-819192-06	284	UZ-AVELI-96-04	327	UZ-CAPRI-96-06	283
UZ-334160-06	280	UZ-819192-07	284	UZ-AZ-012-04	331	UZ-CAPRI-128-01	283
UZ-334192-06	280	UZ-819192-10	284	UZ-AZ-128-04	331	UZ-CAPRI-128-02	283
UZ-334256-06	280	UZ-819192-12	284	UZ-AZ-160-04	331	UZ-CAPRI-128-05	283
UZ-334320-06	280	UZ-819192-14	284	UZ-BAGIO-128-01	273	UZ-CAPRI-128-06	283
UZ-335128-06	280	UZ-819192-15	284	UZ-BAGIO-128-04	273	UZ-CAPRI-160-01	283
UZ-335160-06	280	UZ-819192-20	284	UZ-BAGIO-128-05	273	UZ-CAPRI-160-02	283
UZ-335192-06	280	UZ-819256-01	284	UZ-BAGIO-128-06	273	UZ-CAPRI-160-05	283
UZ-335256-06	280	UZ-819256-02	284	UZ-BAGIO-128-07	273	UZ-CAPRI-160-06	283
UZ-336128-06	281	UZ-819256-05	284	UZ-BAGIO-128-11	273	UZ-CAPRI-192-01	283
UZ-336160-06	281	UZ-819256-06	284	UZ-BAGIO-128-20M	273	UZ-CAPRI-192-02	283
UZ-336192-06	281	UZ-819256-07	284	UZ-BAGIO-160-01	273	UZ-CAPRI-192-05	283
UZ-336256-06	281	UZ-819256-10	284	UZ-BAGIO-160-04	273	UZ-CAPRI-192-06	283
UZ-336320-06	281	UZ-819256-12	284	UZ-BAGIO-160-05	273	UZ-CAPRI-256-01	283
UZ-336416-06	281	UZ-819256-14	284	UZ-BAGIO-160-06	273	UZ-CAPRI-256-02	283
UZ-336480-06	281	UZ-819256-15	284	UZ-BAGIO-160-07	273	UZ-CAPRI-256-05	283
UZ-682128-06	281	UZ-819256-20	284	UZ-BAGIO-160-11	273	UZ-CAPRI-256-06	283
UZ-682160-06	281	UZ-819320-01	284	UZ-BAGIO-160-20M	273	UZ-CAPRI-320-01	283
UZ-682192-06	281	UZ-819320-02	284	UZ-BAGIO-192-01	273	UZ-CAPRI-320-02	283
UZ-682224-06	281	UZ-819320-05	284	UZ-BAGIO-192-04	273	UZ-CAPRI-320-05	283
UZ-682256-06	281	UZ-819320-06	284	UZ-BAGIO-192-05	273	UZ-CAPRI-320-06	283
UZ-682320-06	281	UZ-819320-07	284	UZ-BAGIO-192-06	273	UZ-CLEO-128-01	266
UZ-682416-06	281	UZ-819320-10	284	UZ-BAGIO-192-07	273	UZ-CLEO-128-05	266
UZ-682480-06	281	UZ-819320-12	284	UZ-BAGIO-192-11	273	UZ-CLEO-128-06	266
UZ-804064-01	282	UZ-819320-14	284	UZ-BAGIO-192-20M	273	UZ-CLEO-160-01	266
UZ-819096-01	284	UZ-819320-20	284	UZ-BAGIO-320-01	273	UZ-CLEO-160-05	266
UZ-819096-02	284	UZ-870128-01	286	UZ-BAGIO-320-04	273	UZ-CLEO-160-06	266
UZ-819096-05	284	UZ-872224-01	286	UZ-BAGIO-320-05	273	UZ-CLEO-192-01	266
UZ-819096-06	284	UZ-872224-05	286	UZ-BAGIO-320-06	273	UZ-CLEO-192-05	266
UZ-819096-07	284	UZ-872224-06	286	UZ-BAGIO-320-07	273	UZ-CLEO-192-06	266
UZ-819096-10	284	UZ-880016-01	287	UZ-BAGIO-320-11	273	UZ-COM096-01	340
UZ-819096-12	284	UZ-883016-01	288	UZ-BAGIO-320-20M	273	UZ-COM0128-01	340
UZ-819096-14	284	UZ-883016-02	288	UZ-BIANC-96-01	341	UZ-COM0160-01	340
UZ-819096-20	284	UZ-883016-05	288	UZ-BIANC-128-01	341	UZ-CRA14-128	339
UZ-819128-01	284	UZ-883016-06	288	UZ-CALABRIA160-01	301	UZ-CRA14-192	339
UZ-819128-02	284	UZ-ABIAT-128-04	328	UZ-CALABRIA160-06	301	UZ-CRA14-320	339
UZ-819128-05	284	UZ-ACERA-96-04	329	UZ-CALABRIA192-01	301	UZ-E6-096-01	312
UZ-819128-06	284	UZ-ADRIN-96-04	329	UZ-CALABRIA192-06	301	UZ-E6-096-05	312
UZ-819128-07	284	UZ-ALATR-128-04	321	UZ-CALABRIA224-01	301	UZ-E6-096-06	312
UZ-819128-10	284	UZ-ALRA096-01	298	UZ-CALABRIA224-06	301	UZ-E6-128-01	312
UZ-819128-12	284	UZ-ANCON-128-01	274	UZ-CAMAI-96-01	306	UZ-E6-128-05	312
UZ-819128-14	284	UZ-ANCON-128-05	274	UZ-CAMAI-96-02	306	UZ-E6-128-06	312
UZ-819128-15	284	UZ-ANCON-128-06	274	UZ-CAMAI-96-06	306	UZ-E6-160-01	312
UZ-819128-20	284	UZ-ANCON-192-01	274	UZ-CAMAI-96-09	306	UZ-E6-160-05	312
UZ-819160-01	284	UZ-ANCON-192-05	274	UZ-CAMAI-96-10M	306	UZ-E6-160-06	312
UZ-819160-02	284	UZ-ANCON-192-06	274	UZ-CAMAI-96-12	306	UZ-EAST-128-01	287
UZ-819160-05	284	UZ-ANCON-256-01	274	UZ-CAMAI-96-20M	306	UZ-EAST-128-06	287
UZ-819160-06	284	UZ-ANCON-256-05	274	UZ-CAMAI-128-01	306	UZ-EAST-128-19	287
UZ-819160-07	284	UZ-ANCON-256-06	274	UZ-CAMAI-128-02	306	UZ-FLAVIO-96-01	293

UZ-FLAVIO-96-06	293	UZ-HILL-128-05	267	UZ-MONZA384-20	267	UZ-VARES-128-06	278
UZ-FLAVIO-96-16	293	UZ-HILL-128-06	267	UZ-O160PR-01	268	UZ-VARES-192-01	278
UZ-FLAVIO-96-20M	293	UZ-HILL-128-12	267	UZ-O192PR-01	268	UZ-VARES-192-02	278
UZ-FLAVIO-128-01	293	UZ-HILL-160-01	267	UZ-O256PR-01	268	UZ-VARES-192-05	278
UZ-FLAVIO-128-06	293	UZ-HILL-160-05	267	UZ-OLBIA-96-04	330	UZ-VARES-192-06	278
UZ-FLAVIO-128-16	293	UZ-HILL-160-06	267	UZ-OLBIA-128-04	330	UZ-VASTO-96-09	322
UZ-FLAVIO-128-20M	293	UZ-HILL-160-12	267	UZ-PALER-96-07	322	UZ-VASTO-128-09	322
UZ-FLAVIO-160-01	293	UZ-KATAN-320-01	274	UZ-PALER-128-07	322	UZ-VETA-128-01	266
UZ-FLAVIO-160-06	293	UZ-KATAN-320-12	274	UZ-PRATO-160-01	272	UZ-VETA-128-05	266
UZ-FLAVIO-160-16	293	UZ-LATIN-96-04	330	UZ-PRATO-160-06	272	UZ-VETA-128-12	266
UZ-FLAVIO-160-20M	293	UZ-LUCCA096-01	341	UZ-PRATO-320-01	272	UZ-VETA-160-01	266
UZ-G0-128-01	302	UZ-LUCCA128-01	341	UZ-PRATO-320-06	272	UZ-VETA-160-05	266
UZ-G0-128-05	302	UZ-LUCCA160-01	341	UZ-R132-A1-01	314	UZ-VETA-160-12	266
UZ-G0-128-06	302	UZ-LUCCA192-01	341	UZ-R132-A1-02	314	UZ-VETA-320-01	266
UZ-G0-160-01	302	UZ-LUCCA224-01	341	UZ-R160B1-01	269	UZ-VETA-320-05	266
UZ-G0-160-05	302	UZ-MARSA-64-07	332	UZ-R160PR-01	269	UZ-VETA-320-12	266
UZ-G0-160-06	302	UZ-MARSA-64-09	332	UZ-R256B1-01	269	UZ-VINCE-96-04	326
UZ-G0-192-01	302	UZ-MARSA-64-10M	332	UZ-R256PR-01	269	UZ-VITO-160-01	292
UZ-G0-192-05	302	UZ-MARSA-64-11	332	UZ-REN096-04A	336	UZ-VITO-160-05	292
UZ-G0-192-06	302	UZ-MARSA-64-20M	332	UZ-RENG01-04A	336	UZ-VITO-160-07	292
UZ-G0-256-01	302	UZ-MILAN-128-01	282	UZ-RENG02-04A	336	UZ-VITO-160-12	292
UZ-G0-256-05	302	UZ-MILAN-128-05	282	UZ-ROS160-20	269	UZ-VITO-160-20M	292
UZ-G0-256-06	302	UZ-MILAN-128-06	282	UZ-ROS256-20	269	UZ-VITO-288-01	292
UZ-G1-128-01	302	UZ-MILAN-128-20M	282	UZ-ROYAL1-96-10-03	333	UZ-VITO-288-05	292
UZ-G1-128-05	302	UZ-MILAN-256-01	282	UZ-ROYAL2-96-10-03	333	UZ-VITO-288-07	292
UZ-G1-128-06	302	UZ-MILAN-256-05	282	UZ-ROYAL3-96-10-03	333	UZ-VITO-288-12	292
UZ-G1-128-13	302	UZ-MILAN-256-06	282	UZ-ROYAL4-96-03	333	UZ-VITO-288-20M	292
UZ-G1-160-01	302	UZ-MILAN-256-20M	282	UZ-ROYAL5-96-10-03	333	UZ-WERON-96-04	324
UZ-G1-160-05	302	UZ-MODEN-128-01	277	UZ-ROYAL5-128-10-03	333	UZ-WERON-96-09	324
UZ-G1-160-06	302	UZ-MODEN-128-05	277	UZ-S50-A1-01	314	UZ-WERON-96-12	324
UZ-G1-160-13	302	UZ-MODEN-128-06	277	UZ-S50-A1-02	314	UZ-WERON-128-04	324
UZ-G1-192-01	302	UZ-MODEN-128-20M	277	UZ-S50-A1-06	314	UZ-WERON-128-09	324
UZ-G1-192-05	302	UZ-MODEN-160-01	277	UZ-SIENNA096-01	340	UZ-WERON-128-12	324
UZ-G1-192-06	302	UZ-MODEN-160-05	277	UZ-SIENNA128-01	340	UZ-WP1146-04	334
UZ-G1-192-13	302	UZ-MODEN-160-06	277	UZ-SIENNA160-01	340	UZ-Z10096-01	305
UZ-G1-256-01	302	UZ-MODEN-160-20M	277	UZ-TH096128-01	294	UZ-Z10096-02	305
UZ-G1-256-05	302	UZ-MODEN-192-01	277	UZ-TH096128-05	294	UZ-Z10096-05	305
UZ-G1-256-06	302	UZ-MODEN-192-05	277	UZ-TH096128-06	294	UZ-Z10128-01	305
UZ-G1-256-13	302	UZ-MODEN-192-06	277	UZ-TH160192-01	294	UZ-Z10128-02	305
UZ-G1-320-01	302	UZ-MODEN-192-20M	277	UZ-TH160192-05	294	UZ-Z10128-05	305
UZ-G1-320-05	302	UZ-MONA-128-01-10	268	UZ-TH160192-06	294		
UZ-G1-320-06	302	UZ-MONA-128-01-20	268	UZ-TH288320-01	294		
UZ-G1-320-13	302	UZ-MONA-192-01-10	268	UZ-TH288320-05	294	WA-MALAG-A0-01	358
UZ-G1-416-01	302	UZ-MONA-192-01-20	268	UZ-TH288320-06	294	WA-MALAG-A0-02	358
UZ-G1-416-05	302	UZ-MONA-256-01-10	268	UZ-TIVOL-192-01	272	WA-MALAG-A0-05	358
UZ-G1-416-06	302	UZ-MONA-256-01-20	268	UZ-TIVOL-192-12	272	WA-MALAG-A0-20	358
UZ-G2-160-01	270	UZ-MONZA16-06	267	UZ-TIVOL-192-13	272	WA-MALAG-B0-01	359
UZ-G2-160-06	270	UZ-MONZA16-10	267	UZ-TIVOL-320-01	272	WA-MALAG-B0-02	359
UZ-G2-224-01	270	UZ-MONZA16-20	267	UZ-TIVOL-320-12	272	WA-MALAG-B0-05	359
UZ-G2-224-06	270	UZ-MONZA160-06	267	UZ-TIVOL-320-13	272	WA-MALAG-B0-20	359
UZ-GENUA128-01	301	UZ-MONZA160-10	267	UZ-VARES-96-01	278	WB-073024-01	142
UZ-GENUA128-02	301	UZ-MONZA160-20	267	UZ-VARES-96-02	278	WB-073024-06	142
UZ-GENUA128-05	301	UZ-MONZA256-06	267	UZ-VARES-96-05	278	WB-073025-01	143
UZ-GENUA160-01	301	UZ-MONZA256-10	267	UZ-VARES-96-06	278	WB-073025-06	143
UZ-GENUA160-02	301	UZ-MONZA256-20	267	UZ-VARES-128-01	278	WB-073026-01	143
UZ-GENUA160-05	301	UZ-MONZA384-06	267	UZ-VARES-128-02	278	WB-073026-06	143
UZ-HILL-128-01	267	UZ-MONZA384-10	267	UZ-VARES-128-05	278	WB-WS-12-010	144

W

WB-WS-12-020	144	WG-POBUWM70-10	188	WW-2KOSZ0-05	201	W-WSPD70-BP-10	197
WB-WS-12-031	144	WG-POBUWM70-60	188	WW-K0AJ03-01	210	W-WSPD70-BP-60	196
WB-WS-12-032	144	WG-POBUWM80-10	188	WW-K0AJ04-01	212	W-WSPD70-VE-60	196, 197
WB-WS-12-033	144	WG-POBUWM80-60	188	WW-K00J03-01	211	W-WSPD80-BP-10	197
WB-WS-12-060	144	WG-POBUWM90-10	188	WW-KJ0101-01	209	W-WSPD80-BP-60	196
WB-WS-18-010	144	WG-POBUWM90-60	188	WW-KJ0201-01	210	W-WSPD80-VE-10	197
WB-WS-18-020	144	WG-PRZEG60-10	189	W-WK060-BP-10	199	W-WSPD80-VE-60	196
WB-WS-18-030	144	WG-PRZEG60-60	189	W-WK060-BP-60	198	W-WSPD90-BP-10	197
WB-WS-18-031	144	WG-PRZEG70-10	189	W-WK060-VE-10	199	W-WSPD90-BP-60	196
WB-WS-18-032	144	WG-PRZEG70-60	189	W-WK060-VE-60	198	W-WSPD90-VE-10	197
WB-WS-18-033	144	WG-PRZEG80-10	189	W-WK070-BP-10	199	W-WSPD90-VE-60	196
WB-WS-18-060	144	WG-PRZEG80-60	189	W-WK070-BP-60	198	WW-SPODN0-05	211
WB-WS-24-010	145	WG-PRZEG90-10	189	W-WK070-VE-10	199	WW-WSD250-01B	215
WB-WS-24-020	145	WG-PRZEG90-60	189	W-WK070-VE-60	198	WW-WSD300-01B	215
WB-WS-24-030	145	WG-RDRO-10	192	W-WK080-BP-10	199	WW-WSD350-01B	215
WB-WS-24-031	145	WG-RDRO-60	192	W-WK080-BP-60	198	WW-WSD400-01B	215
WB-WS-24-032	145	WG-RDRP-10	192	W-WK080-VE-10	199	WW-WSD450-01B	215
WB-WS-24-033	145	WG-RDRP-60	192	W-WK080-VE-60	198	WW-WSD500-01B	215
WB-WS-24-060	145	WG-RRPS300-10	192	W-WK090-BP-10	199	WW-WSL250-01	214
W-CUSTOMI-60L450	242	WG-RRPS300-60	192	W-WK090-BP-60	198	WW-WSL250-01B	214
W-CUSTOMI-60L500	242	WG-WSPOD60-10	190	W-WK090-VE-10	199	WW-WSL300-01	214
W-CUSTOMI-80L450	243	WG-WSPOD60-60	190	W-WK090-VE-60	198	WW-WSL300-01B	214
W-CUSTOMI-80L500	243	WG-WSPOD70-10	190	WW-KOSZ60-01	203	WW-WSL350-01	214
WG-KOSZ60-10	185	WG-WSPOD70-60	190	WW-KOSZ60-PW	203	WW-WSL350-01B	214
WG-KOSZ60-60	185	WG-WSPOD80-10	190	WW-KOSZ70-05	203	WW-WSL400-01	214
WG-KOSZ70-10	185	WG-WSPOD80-60	190	WW-KOSZ70-PW	203	WW-WSL400-01B	214
WG-KOSZ70-60	185	WG-WSPOD90-10	190	WW-KOSZ80-05	203	WW-WSL450-01	214
WG-KOSZ80-10	185	WG-WSPOD90-60	190	WW-KOSZ80-PW	203	WW-WSL450-01B	214
WG-KOSZ80-60	185	W-INSERTI-L450	244	WW-KOSZ90-01	203	WW-WSL500-01	214
WG-KOSZ90-10	185	W-INSERTI-L500	244	WW-KOSZ90-PW	203	WW-WSL500-01B	214
WG-KOSZ90-60	185	WK-CAM-15-12-PE	156	WW-KRAW00-20	209	WW-WSL000-01	208
WG-KOSZM60-10	184	WK-CAM-15-13-P	157	W-WKRP-BP-10	200	WW-WSP000-01	208
WG-KOSZM60-60	184	WK-CAM-FI35	155	W-WKRP-BP-60	200	WW-WSP060-05	204
WG-KOSZM70-10	184	WK-CF0750-01	158	W-WKRP-VE-10	200	WW-WSP060-PW	204
WG-KOSZM70-60	184	WK-CF6450-01	158	W-WKRP-VE-60	200	WW-WSP070-05	204
WG-KOSZM80-10	184	WK-D0310-001	156	W-WOBU60-BP-10	195	WW-WSP070-PW	204
WG-KOSZM80-60	184	WK-D0313-001	156	W-WOBU60-BP-60	194	WW-WSP080-05	204
WG-KOSZM90-10	184	WK-D0316-001	156	W-WOBU60-VE-10	195	WW-WSP080-PW	204
WG-KOSZM90-60	184	WK-D0320-001*	156	W-WOBU60-VE-60	194	WW-WSP090-05	204
WG-KOSZR60-10	186	WK-D0325-001*	156	W-WOBU70-BP-10	195	WW-WSP090-PW	204
WG-KOSZR60-60	186	WK-D0330-001*	156	W-WOBU70-BP-60	194	WW-WSPP00-01	208
WG-KOSZR70-10	186	WK-D0416-001	156	W-WOBU70-VE-10	195	WW-WUBR00-01	212
WG-KOSZR70-60	186	WK-D0425-001*	156	W-WOBU70-VE-60	194	WW-ZWBUT2-10	216
WG-KOSZR80-10	186	WK-D0430-001	156	W-WOBU80-BP-10	195	WW-ZWBUT2-20	216
WG-KOSZR80-60	186	WK-D0440-001	156	W-WOBU80-BP-60	194	WZ-00-K24-04	364
WG-KOSZR90-10	186	WK-D0460-001	156	W-WOBU80-VE-10	195	WZ-804-20-01	349
WG-KOSZR90-60	186	WK-D3516-001	156	W-WOBU80-VE-60	194	WZ-804-20-05	349
WG-POBUW60-10	187	WK-D3525-001	156	W-WOBU90-BP-10	195	WZ-804-20-06	349
WG-POBUW60-60	187	WK-D3530-001	156	W-WOBU90-BP-60	194	WZ-A0-K23-01	354
WG-POBUW70-10	187	WK-DOW63X45-P	157	W-WOBU90-VE-10	195	WZ-A0-K23-02	354
WG-POBUW70-60	187	WK-MUFAWK-01	155	W-WOBU90-VE-60	194	WZ-A0-K23-03	354
WG-POBUW80-10	187	WK-TCAMS-D-88	155	WW-PASEK0-05	213	WZ-A0-K23-04	354
WG-POBUW80-60	187	WK-TRZP35-01	155	WW-SE0102-01	213	WZ-A0-K23-05	354
WG-POBUW90-10	187	WK-TRZP55-01	155	W-WSPD60-BP-10	197	WZ-A0-K23-06	354
WG-POBUW90-60	187	WS-QUAD-14-06	348	W-WSPD60-BP-60	196	WZ-A0-K23-07	354
WG-POBUWM60-10	188	WS-ROND-14-06	349	W-WSPD60-VE-10	197	WZ-A0-K23-20	354
WG-POBUWM60-60	188	WS-SOLO-14-06	348	W-WSPD60-VE-60	196	WZ-A0-K24-01	356

WZ-A0-K24-02	356	WZ-K2201-01	353	ZK-ZAW-R0-30	150	WP-CIG-09UZC	34
WZ-A0-K24-03	356	WZ-K2201-06	353	ZM-CNHC07BR2	15	WP-CIG-09UZE	34
WZ-A0-K24-04	356	WZ-K2201-CS	353	ZM-CNHC08BR2	14	WP-CIG-17OZE	34
WZ-A0-K24-05	356	WZ-K2201-CZ	353	ZM-CNHC09BR2	14	WP-CIG-17UZE	34
WZ-A0-K24-07	356	WZ-K2201-NB	353	ZM-DCHC07-3DBEO	10	WP-CIG-19OZE	34
WZ-A0-K24-20	356	WZ-K2201-PM	353	ZM-DCHC07-3DZEO	10	WP-CIG-19UZE	34
WZ-B0-K23-01	354	WZ-K2201-RZ	353	ZM-DCHC08-3DBEO	9	WP-CIHC07OZE	32
WZ-B0-K23-02	354	WZ-K2201-ZL	353	ZM-DCHC08-3DZEO	9	WP-CIHC08OZE	31
WZ-B0-K23-03	354	WZ-K2202-01	353	ZM-DCHC09-3DBEO	9	WP-CIHC09OZE	31
WZ-B0-K23-04	354	WZ-K2202-06	353	ZM-DCHC09-3DZEO	9	WP-COCA450-BE	29
WZ-B0-K23-05	354	WZ-K2202-CS	353	ZM-ECHC07BEO	11	WP-COCA450-ZE	29
WZ-B0-K23-06	354	WZ-K2202-CZ	353	ZM-ECHC07ZEO	11	WP-COCA7450-BE	29
WZ-B0-K23-07	354	WZ-K2202-PM	353	ZM-ECHC08BEO	11	WP-CONL07-BE	23
WZ-B0-K23-20	354	WZ-K2202-RZ	353	ZM-ECHC08ZEO	11	WP-CONL07-ZE	23
WZ-B0-K24-01	357	WZ-MADRYT-04	362	ZM-ECHC09BEO	10	WP-CONL08-BE	23
WZ-B0-K24-02	357	WZ-MADRYT-07	362	ZM-ECHC09H04-BE	12	WP-CONL08-ZE	23
WZ-B0-K24-03	357	WZ-MADRYT-15	362	ZM-ECHC09ZEO	10	WP-CONL09-BE	22
WZ-B0-K24-04	357	WZ-MADRYT-20M	362	ZM-HCKT30-BE-S	17	WP-CONL09-ZE	22
WZ-B0-K24-05	357	WZ-MALAG-C0-01	359	ZM-HCKT30-ZE-S	17	WP-JUNIOR-00	37
WZ-B0-K24-07	357	WZ-MALAG-C0-02	359	ZM-HCKT45-3DBEO-S	18	WP-KT30H2-BE	25
WZ-B0-K24-20	357	WZ-MALAG-C0-05	359	ZM-HCKT45-BE-S	17	WP-KT45H2-ZE	26
WZ-C0-K24-01	358	WZ-MALAG-C0-20	359	ZM-HCKT45-ZE-S	17	WP-KT90H2-BE	26
WZ-C0-K24-02	358	WZ-ORVIE-A0-09	363	ZM-HCKT90-3DBEO-S	19	WP-KT90H2-ZE	26
WZ-C0-K24-03	358	WZ-ORVIE-B0-09	363	ZM-HCKT90-BE-S	18	WP-KT135H2BE	28
WZ-C0-K24-04	358	WZ-SCTYLPR-BWK	149	ZM-HCKT90-ZE-S	18	WP-KT135H2ZE	28
WZ-C0-K24-05	358	WZ-SCTYLPR-WK	149	ZM-HCKT155BE	19	WP-KT165H2BE	28
WZ-C0-K24-20	358	WZ-TOLED-A0-01	350	ZM-HCKT155ZE	19	WP-KT165H2ZE	28
WZ-CORDOBA-01	352	WZ-TOLED-A0-02	350	ZM-HCKT165-3DBEO-S	20	WP-KT0270-BE	36
WZ-CORDOBA-06	352	WZ-TOLED-A0-05	350	ZM-HCKT165BE-S	20	WP-KTK90H6BE	27
WZ-CORDOBA-20M	352	WZ-TOLED-A0-06	350	ZM-HCKT165ZE-S	20	WP-KTK90H6ZE	27
WZ-CORUNA-D-04	361	WZ-TOLED-A0-20M	350	ZM-HCRALU9BE	35	WP-KTKN90H0-BE	27
WZ-CORUNA-D-07	361	WZ-TOLED-B0-01	350	ZM-INHC070BEO	16	WP-P07H045BE	30
WZ-CORUNA-D-17	361	WZ-TOLED-B0-02	350	ZM-INHC070ZEO	16	WP-POH045BEO	30
WZ-CORUNA-D-20M	361	WZ-TOLED-B0-05	350	ZM-INHC080BEO	16	WP-POH045ZEO	30
WZ-CORUNA-M-04	361	WZ-TOLED-B0-06	350	ZM-INHC080ZEO	16	WP-RALUH2-00	35
WZ-CORUNA-M-07	361	WZ-TOLED-B0-20M	350	ZM-INHC090BEO	15	WP-SKR-00-80	38
WZ-CORUNA-M-17	361	WZ-TOLED-C0-01	351	ZM-INHC090ZEO	15	ZT-HF-01-D00	36, 37
WZ-CORUNA-M-20M	361	WZ-TOLED-C0-02	351	ZM-KT45H2-BE	26	ZZ-16-103-01	254
WZ-D-892-02	360	WZ-TOLED-C0-05	351	ZP-BICN070BEO	25	ZZ-20-103-01	254
WZ-D-892-05	360	WZ-TOLED-C0-06	351	ZP-BICN070ZEO	25	ZZ-30-103-01	254
WZ-E-018-01	360	WZ-TOLED-C0-05	351	ZP-BICN072BEO	25	ZZ-B0-105-01	254
WZ-E-018-02	360	WZ-TOLED-C0-06	351	ZP-BICN072ZEO	25	ZZ-BA-SK0-01	259
WZ-E-018-05	360	WZ-WALENCIA-01	352	ZP-BICN080BEO	24	ZZ-BA-SK0-PR	259
WZ-E-018-06	360	WZ-WALENCIA-06	352	ZP-BICN080ZEO	24	ZZ-C1-288-01	258
WZ-E-018-20M	360	WZ-WALENCIA-20M	352	ZP-BICN082BEO	24	ZZ-C5-288-01	258
WZ-GRANA-A0-01	356	Z		ZP-BICN082ZEO	24	ZZ-C6-288-01	258
WZ-GRANA-A0-02	356	ZASL-MIMO35-10	155	ZP-BICN090BEO	24	ZZ-C8-288-01	258
WZ-K23-D1-01	355	ZC-GTV-12-00	38	ZP-BICN090ZEO	24	ZZ-CF-138-01	252
WZ-K23-D1-02	355	ZC-GTV-14-00	38	ZP-BICN092BEO	24	ZZ-G0-328-01	257
WZ-K23-D1-03	355	ZK-FORCE-KPL	150	ZP-BICN092ZEO	24	ZZ-KLMASTER	253
WZ-K23-D1-05	355	ZK-R1-KPL-10	151	ZP-BID107-3DBEO	22	ZZ-KM-138-01	251
WZ-K23-D1-06	355	ZK-R1-KPL-30	151	ZP-BID108-3DBEO	21	ZZ-M0-201-01	256
WZ-K23-E1-01	355	ZK-STRONG-KPL	151	ZP-BID109-3DBEO	21	ZZ-SP-105-05	258
WZ-K23-E1-02	355	ZK-ZAS-KPL-10	152	ZP-CIBI7H0ZE	33	ZZ-SP-KLMASTER	258
WZ-K23-E1-03	355	ZK-ZAS-KPL-31	152	ZP-CIBI8H0ZE	33	ZZ-SZ-407-01	255
WZ-K23-E1-05	355	ZK-ZAS-KPL-32	152	ZP-CIBI9H0ZE	32	ZZ-SZ-408-01	255
WZ-K23-E1-06	355	ZK-ZAW-R0-10	150	ZP-CIG-07OZE	34	ZZ-SZ-409-01	256
				ZP-CIG-07UZE	34	ZZ-Z0-202-01	257
				ZP-CIG-09OZE	34	ZZ-ZN-138-01	252
				ZP-CIG-09UBE	34	ZZ-ZN-338-01	253

ОŚMIETLENIE MEBLÓWE
FURNITURE LIGHTING
МЕБЕЛЬНОЕ ОСВЕЩЕНИЕ

SYSTEMY PRZESUWNE
SLIDING DOOR SYSTEMS
РАЗДВИЖНЫЕ СИСТЕМЫ

AKCESORIA DEKORACYJNE
DECORATIVE ACCESSORIES
ЛИЦЕВАЯ ФУРНИТУРА

AKCESORIA FUNKCYJNE
FUNCTIONAL ACCESSORIES
ФУНКЦИОНАЛЬНАЯ ФУРНИТУРА